

COUNT		DESCRIPTION OF REVISIONS		BY	CHKD	DATE	COUNT	DESCRIPTION OF REVISIONS		BY	CHKD	DATE
△	△						△					
△	△						△					
△	△						△					

NOTE1. THIS CONNECTOR SHALL BE USED WITH A RETAINER  
 (CL755-0006-2).

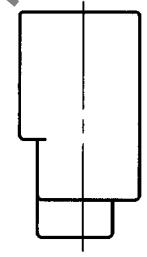
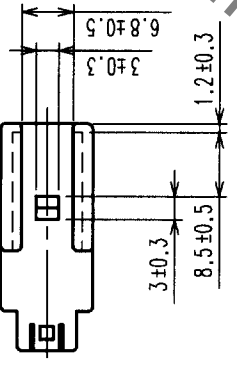
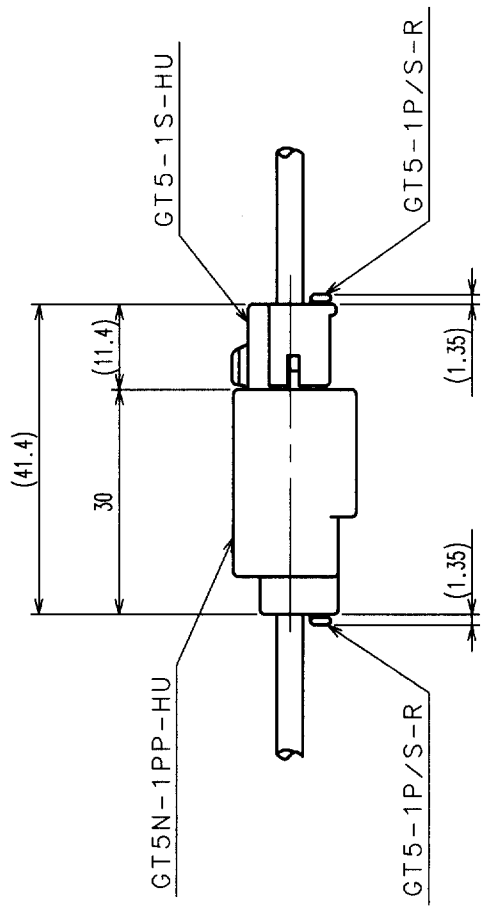
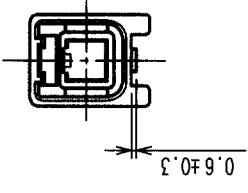
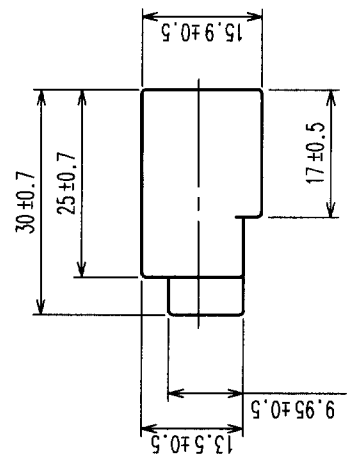
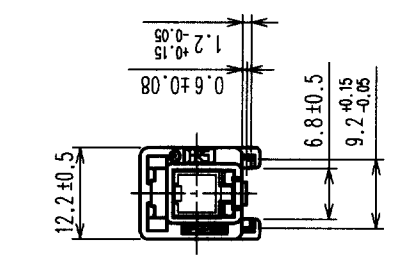
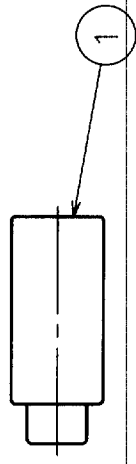

MATED CONNECTORS

HRS DRAWING FOR REFERENCE

1		UL94HB, LIGHT GRAY		FINISH, REMARKS		MATERIAL		FINISH, REMARKS	
NO.	PBT								
CODE NO. (OLD)									
DRAWN		DESIGNED		CHECKED		APPROVED		RELEASED	
T. IKEDA		T. IKEDA		M. Shoda		K. Aoto			
'01 12 03		'01 12 11		20/12/15		22.2.25			
SCALE		DRAWING NO.		PART NO.		GT5N-1PP-HU			
1 : 1		EDC3-165658							
UNITS		HIRSE ELECTRIC CO., LTD		CODE NO.		CL755-0090-9			
mm		HRS							

TO			
----	--	--	--