

2.92mm coaxial connectors MIL Standard Compliant

2.92mm Series



Compatible with 40GHz configurations

■ Features

1. Compliant MIL-STD-348B Standard
2. Supports up to 40GHz frequency
3. Screw mounting



- Provides excellent high frequency performance and consistent mounting quality
- Reusable
- Reduces mounting complexity (No Soldering is required)

4. Flexible PCB thickness
5. 0.085 inch flexible cable applicable
6. RoHS2 compliant

■ Applications

Data transmission measurement, Radio communication equipment, Measuring instruments, RF module, Radio power amplifier, High speed router, High speed switch etc.

■ Functional diagram

Plug side	
■ Straight plug HK-P-SF085 	■ Nonreflective terminator HK-TMP 

Receptacle side
■ Straight receptacle HK-R201 HK-R401 

In-line Adapter		
■ Straight adapter ● Plug—Jack HK-A-PJ 	● Jack—Jack HK-A-JJ 	● Plug—Plug HK-A-PP 

■ Plug receptacle HK-PR201 

Attenuator
■ Plug—Jack HK-AT (**)-PJ **: 0, 1, 2, 3, 4, 5, 6, 7, 8, 9, 10, 20dB 

■ PCB vertical launch receptacle (For high-speed test board applications.) HK-R-SR2-1 

■ PCB end launch receptacle (For high-speed test board applications.) HK-LR-SR2 

Product Specifications

Ratings	Nominal characteristic impedance	50Ω	Operating Temperature Range	-55°C to +105°C (95% RH or less)
	Rated frequency	0 to 40GHz	Storage Temperature Range	-55°C to +50°C (95% RH or less)

Items	Specifications	Conditions	
1. Contact resistance	Center : Not greater than 6mΩ External : Not greater than 2mΩ	Measured at 100mA or below	
2. Insulation resistance	1,000MΩ min.	Measured at 500V DC	
3. Withstanding voltage	No flashover or breakdown	500V AC for one minute	
4. Voltage standing wave ratio	●HK-P-SF085, HK-R-201/401 V.S.W.R. : Not greater than 1.15 (0 to 18GHz)	●HK-R-SR2-1 V.S.W.R. : Not greater than 1.10 (0 to 18GHz)	●HK-LR-SR2 V.S.W.R. : Not greater than 1.30 (0 to 40GHz)
	V.S.W.R. : Not greater than 1.20 (18GHz to 26.5GHz)	V.S.W.R. : Not greater than 1.15 (18GHz to 26.5GHz)	
	V.S.W.R. : Not greater than 1.35 (26.5GHz to 40GHz)	V.S.W.R. : Not greater than 1.30 (26.5GHz to 40GHz)	
5. Mating Cycles	Contact resistance at center : Not greater than 8mΩ External : Not greater than 4mΩ No broken, cracked, or loose parts	500 cycles	
6. Vibration resistance	No electrical discontinuity for not less than 1μs. No broken, cracked, or loose parts	Frequency : 10 to 2000Hz, half amplitude : 0.75mm, Acceleration : 196m/s ² , 10 cycles in each of the 3 axis	
7. Shock resistance	No electrical discontinuity for not less than 1μs. No broken, cracked, or loose parts	Acceleration : 1960m/s ² , duration : 6ms, Wave form : half-sine wave, 3 times in each of the 3 axis	
8. Moisture resistance of temperature/humidity cycle	Insulation resistance : Not less than 100MΩ (in a high humidity environment) Insulation resistance : Not less than 1,000MΩ (in a dry environment) No broken, cracked or loose parts	Left for 10 cycles (240 hours) in an environment with the temperature ranging from -10 to 65°C and the humidity ranging from 90 to 98%.	
9. Temperature cycle	No broken, cracked or loose parts	5 cycles of the following test series condition : Temperature : -55°C → — → +105°C → — Time : 30 min. → 3 min. → 30 min. → 3 min.	
10. Salt spray	No considerable corrosion	Continuous 48 hour cycle in 5% salt water solution	

*Measurement of voltage standing wave ratio (V.S.W.R.)

The specified values of the voltage standing wave ratio (V.S.W.R.) noted above, are taken with the test set up shown in the figure below:

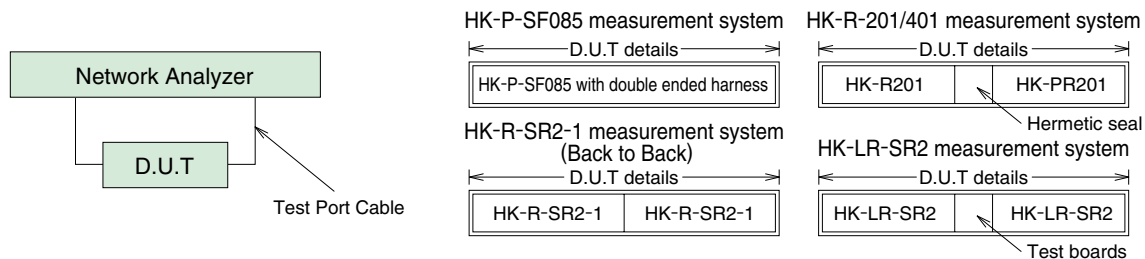

Materials / Finish

Part	Materials	Finish
Shell	Stainless steel / Brass	Passivated / Gold plating
Insulator	PPO / PTFE / PEI resin	—
Contact	Beryllium copper	Gold plated
Ring	Stainless steel	Gold plated

Product Number Structure

Refer to the chart below when determining the product specifications from the product number. Please select from the product numbers listed in this catalog when placing orders.

HK - [] - []

① ② ③

① Series name : HK	③ Applicable cable or board mounting style SF085 : 0.085-inch, Flexible cable SR : PCB screw-mounting
② Connector type P : Straight plug R : Receptacle PR : Plug receptacle A : Adapter	

■ Plug

HK-P-SF085

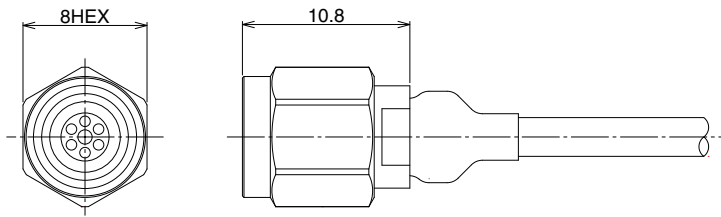

[Please contact Hirose in case of cable assemblies.]

■ Receptacle

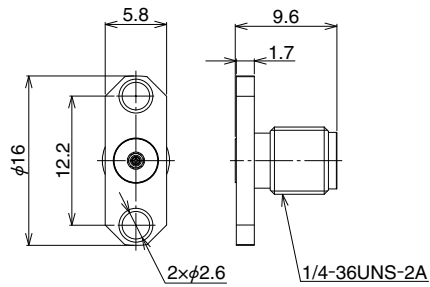

Part No.	HRS No.
HK-R201	338-0073-1

*Compliant with hermetic seal of φ0.3mm pin.

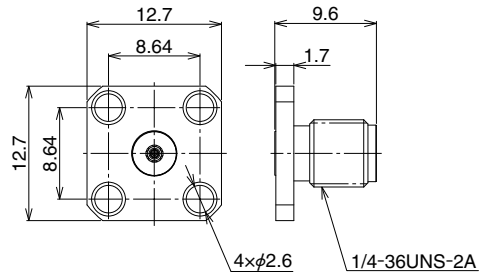

Part No.	HRS No.
HK-R401	338-0074-4

*Compliant with hermetic seal of φ0.3mm pin.

■ Plug-receptacle

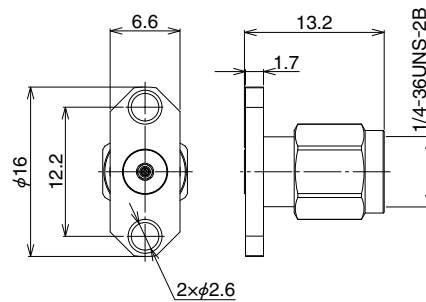

Part No.	HRS No.
HK-PR201	338-0075-7

*Compliant with hermetic seal of φ0.3mm pin.

PCB vertical mount receptacle

This receptacle is designed for high speed test board applications. Not applicable to actual commercial equipments.

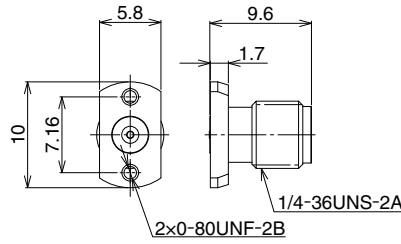

Part No.	HRS No.	Attached screw
HK-R-SR2-1	338-0003-0	—
HK-R-SR2-1(11)	338-0003-0 11	0-80UNF 1/4 inch
HK-R-SR2-1(12)	338-0003-0 12	0-80UNF 3/16 inch

◆ Frequency characteristics (TYPICAL)

*Signal line length between both connector ends : 25mm

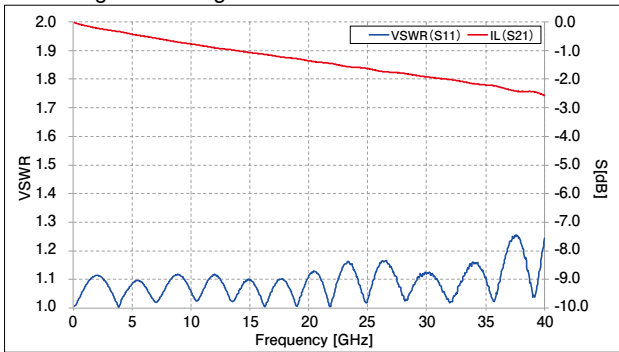

PCB end launch receptacle

Central contact solderless receptacles for high-speed test board applications. Not applicable to actual commercial equipments.

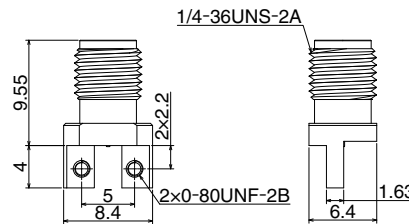

Part No.	HRS No.	Attached screw
HK-LR-SR2	338-0079-0	—
HK-LR-SR2(11)	338-0079-0 11	0-80UNF 1/4 inch
HK-LR-SR2(12)	338-0079-0 12	0-80UNF 3/16 inch

◆ Frequency characteristics (TYPICAL)

*Coplanar line length between both connector ends : 20mm

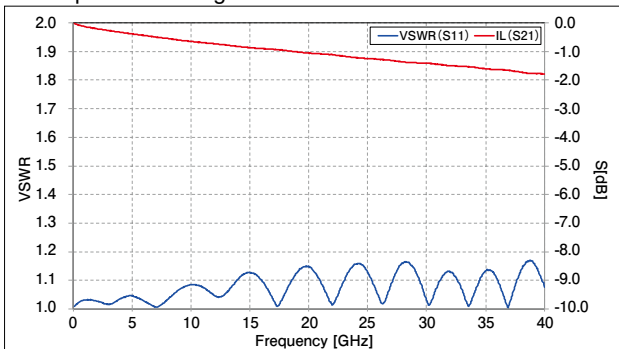

In-line Adapter

● Straight adapter
(Plug — Jack)

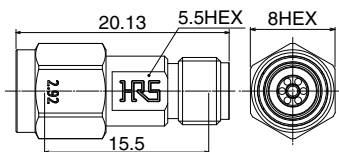

Part No.	HRS No.	V.S.W.R. (Max)		
		0-18GHz	18-26.5GHz	26.5-40GHz
HK-A-PJ	338-0097-0	1.1	1.15	1.2

(Jack — Jack)

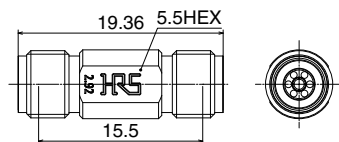

Part No.	HRS No.	V.S.W.R. (Max)		
		0-18GHz	18-26.5GHz	26.5-40GHz
HK-A-JJ	338-0098-0	1.1	1.15	1.2

(Plug — Plug)

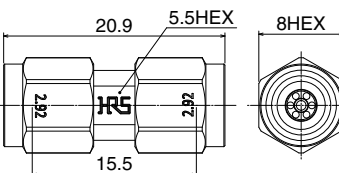

Part No.	HRS No.	V.S.W.R. (Max)		
		0-18GHz	18-26.5GHz	26.5-40GHz
HK-A-PP	338-0099-0	1.1	1.15	1.2

◆ Frequency characteristics (TYPICAL)

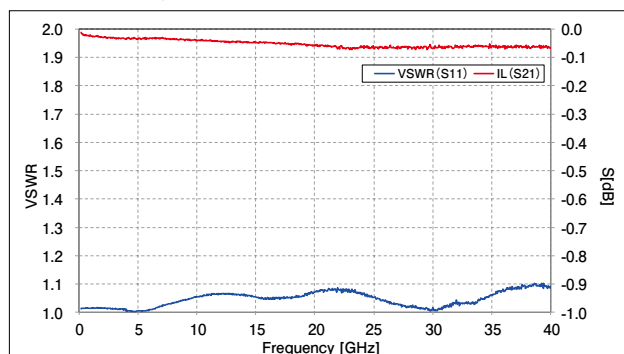

■ Nonreflective terminator
■ Product Specifications

Ratings	Nominal characteristic impedance	50Ω	Operating Temperature Range	-40°C to +85°C
	Rated frequency	0 to 40GHz		
	Power	0.5W CW (+75°C)	Operating relative humidity	95% RH or less

■ Materials / Finish

Part	Materials	Finish
Shell	Stainless steel	Passivate
Insulator	PTFE	—
Male contact	Brass	Gold plated
Coupling	Stainless steel	Passivate
Resistive element	Metal film	—

■ Product Number Structure

HK - TM P

① ② ③

① Series name	HK
② TM	Non-reflective terminator
③ Connector type	P : Plug type

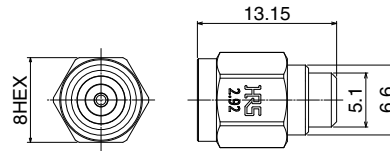

Part No.	HRS No.	V.S.W.R. (Max)			
		0-10GHz	10-20GHz	20-35GHz	35-40GHz
HK-TMP	353-0014-0	1.1	1.15	1.18	1.28

◆ Frequency characteristics (TYPICAL)

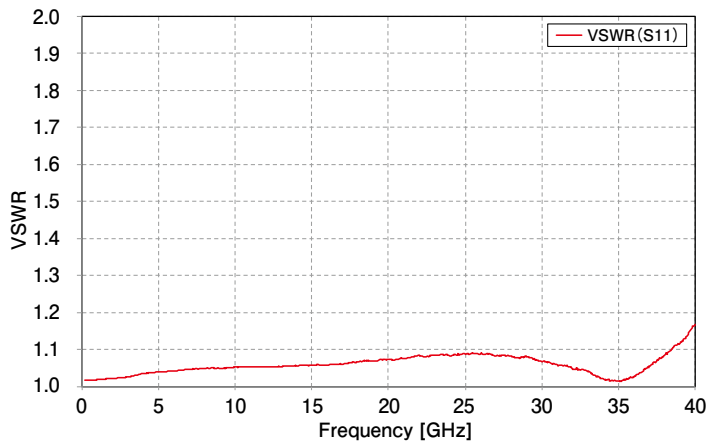

May.1.2020 Copyright 2020 HIROSE ELECTRIC CO., LTD. All Rights Reserved.

Attenuator Product Specifications

Ratings	Nominal characteristic impedance	50Ω	Operating Temperature Range	-10°C to +65°C
	Rated frequency	0 to 40GHz		
	Power	1W CW (+65°C)	Operating relative humidity	90% RH or less

Materials / Finish

Part	Materials	Finish
Shell	Stainless steel	Passivate
Insulator	PTFE resin	—
Male contact	Brass	Gold plated
Female contact	Beryllium copper	Gold plated
Coupling	Stainless steel	Passivate
Resistive element	Metal film	—



Product Number Structure

HK - AT (※※) - PJ

① Series name	HK
② AT	Attenuator
③ Attenuation	(例) (0) : 0dB (through) (3) : 3dB (10) : 10dB
④ Connector type	PJ : Plug Jack

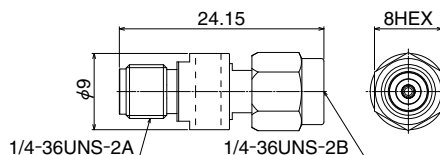

Part No.	HRS No.	Attenuation (dB)			Voltage standing wave ratio (V.S.W.R.)(max)	
		0~18GHz	18~26.5GHz	26.5~40GHz	0~12GHz	12~40GHz
HK-AT(0)-PJ	354-0295-0	0 ^{+0.4} ₀	0 ^{+0.5} ₀	0 ^{+0.8} ₀	1.35	1.4
HK-AT(1)-PJ	354-0316-0	1 ^{+0.9} _{-0.3}	1 ^{+1.0} _{-0.3}	1 ^{+1.2} _{-0.3}	1.3	
HK-AT(2)-PJ	354-0317-0	2 ^{+0.9} _{-0.3}	2 ^{+1.0} _{-0.3}	2 ^{+1.2} _{-0.3}		
HK-AT(3)-PJ	354-0296-0	3 ^{+0.7} _{-0.3}	3 ^{+0.8} _{-0.3}	3 ^{+1.0} _{-0.3}		
HK-AT(4)-PJ	354-0318-0	4 ^{+0.8} _{-0.4}	4 ^{+0.9} _{-0.4}	4 ^{+1.1} _{-0.4}		
HK-AT(5)-PJ	354-0319-0	5 ^{+0.9} _{-0.4}	5 ^{+1.0} _{-0.4}	5 ^{+1.2} _{-0.4}	1.35	1.45
HK-AT(6)-PJ	354-0297-0	6 ^{+0.8} _{-0.2}	6 ^{+0.9} _{-0.2}	6 ^{+1.0} _{-0.2}		
HK-AT(7)-PJ	354-0320-0	7 ^{+1.0} _{-0.4}	7 ^{+1.1} _{-0.4}	7 ^{+1.3} _{-0.4}		
HK-AT(8)-PJ	354-0321-0	8 ^{+0.9} _{-0.5}	8 ^{+1.0} _{-0.5}	8 ^{+1.2} _{-0.5}		
HK-AT(9)-PJ	354-0322-0	9 ^{+0.9} _{-0.5}	9 ^{+1.0} _{-0.5}	9 ^{+1.2} _{-0.5}	1.3	1.4
HK-AT(10)-PJ	354-0298-0	10 ^{+0.9} _{-0.5}	10 ^{+1.0} _{-0.5}	10 ^{+1.2} _{-0.5}		
HK-AT(20)-PJ	354-0299-0	20±1.0	20 ^{+1.2} _{-1.0}	20 ^{+1.4} _{-1.0}	1.25	1.4

◆ Frequency characteristics (TYPICAL)

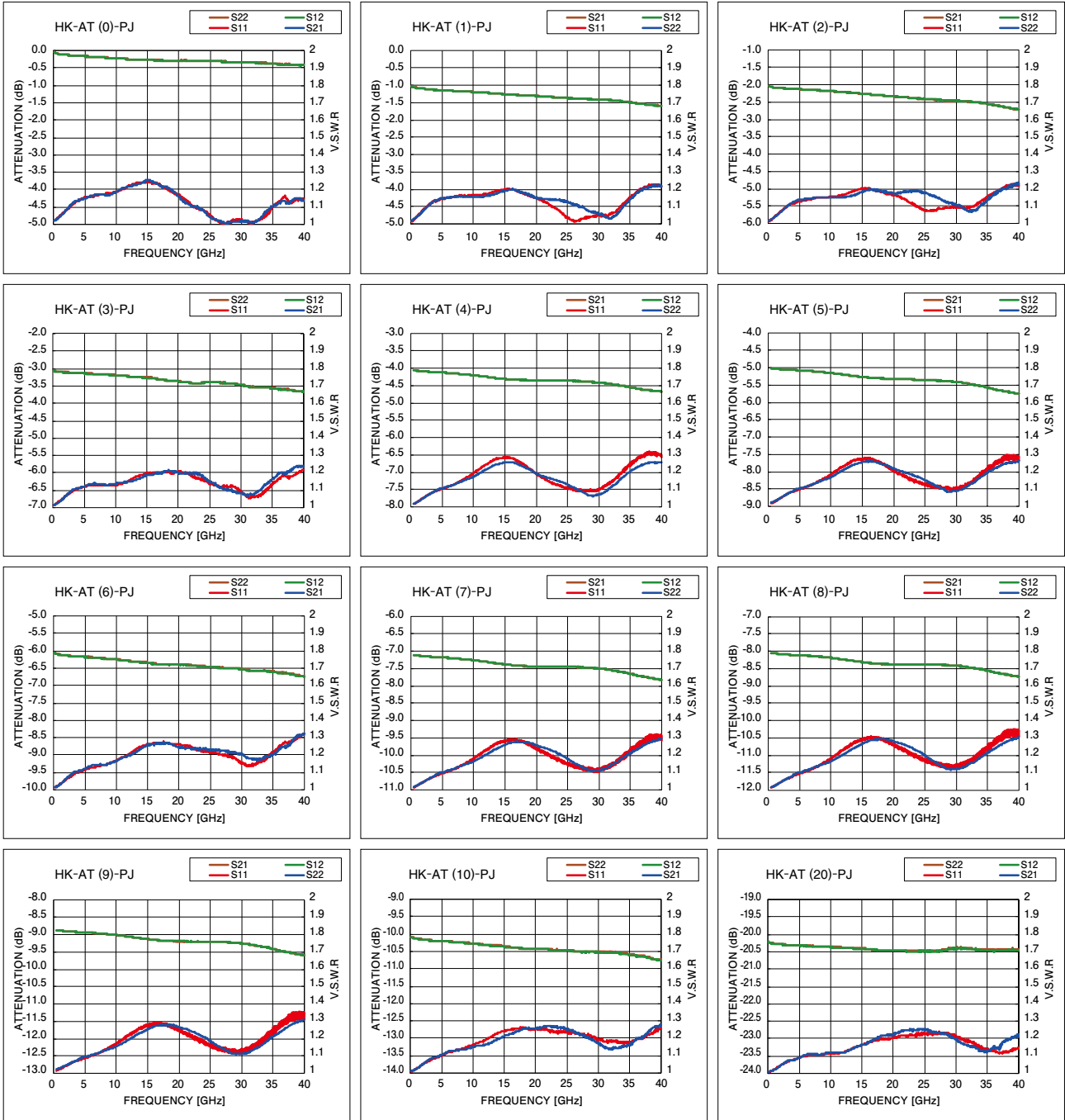

◆ Precautions

1. The diameter of the center contact pin is only 0.92mm.
Please handle with care. When mating the attenuator with the corresponding connector, rotate the hex part only.
2. When mating the attenuator, if any dust is found on the shell interface, please wipe with alcohol.



HIROSE ELECTRIC CO.,LTD.

2-6-3,Nakagawa Chuoh,Tsuzuki-Ku,Yokohama-Shi 224-8540,JAPAN

TEL: +81-45-620-3526 Fax: +81-45-591-3726

<http://www.hirose.com>

<http://www.hirose-connectors.com>