

Jun.1.2020 Copyright 2020 HIROSE ELECTRIC CO., LTD. All Rights Reserved.
 In case of consideration for using Automotive equipment / device which demand high reliability, kindly contact our sales window correspondents.

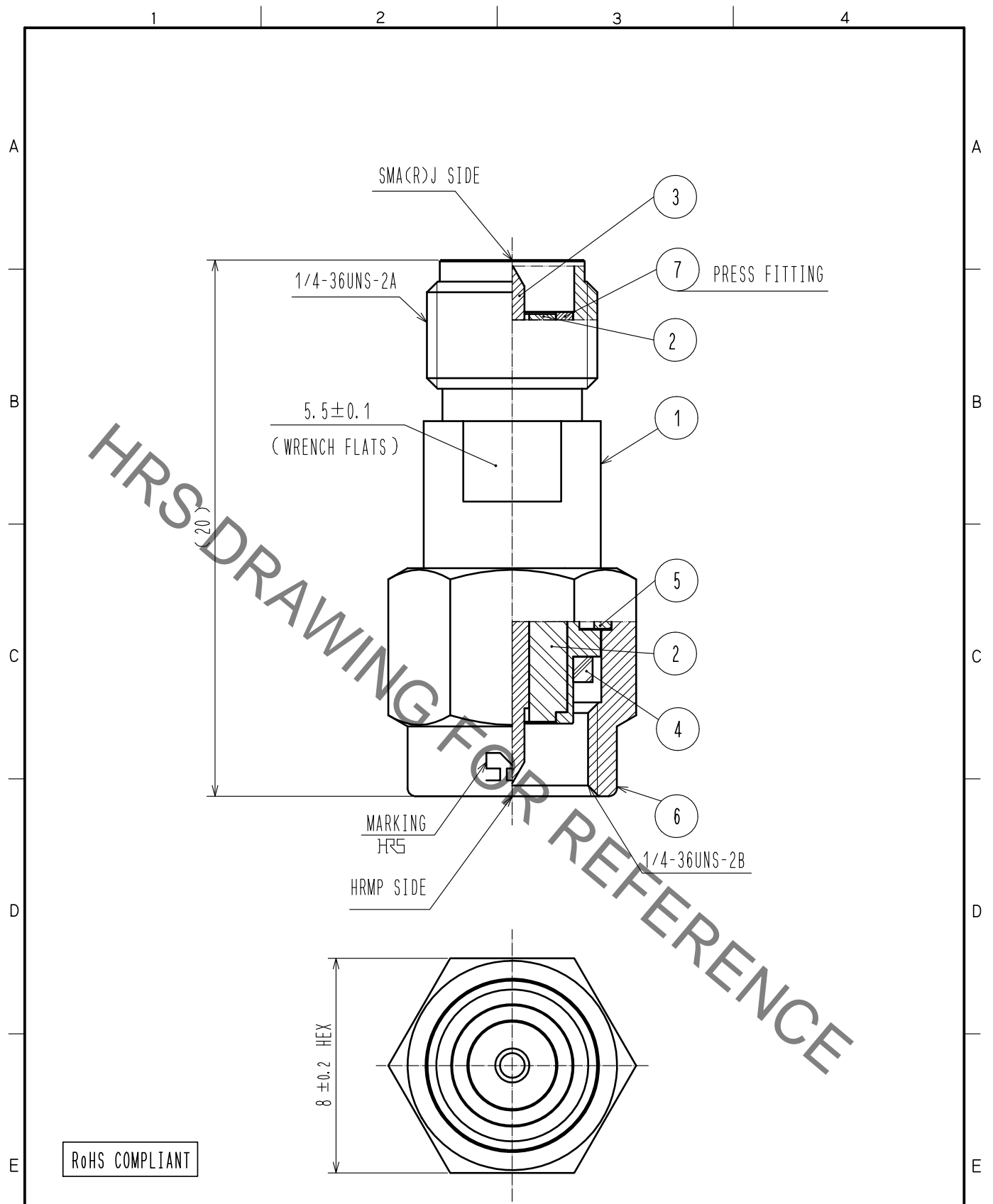

4	SILICON RUBBER				
3	BRASS	GOLD PLATING	7	STAINLESS STEEL	PASSIVATED
2	PTFE		6	STAINLESS STEEL	PASSIVATED
1	STAINLESS STEEL	PASSIVATED	5	BERYLLIUM COPPER	NICKEL PLATING
NO.	MATERIAL	FINISH . REMARKS	NO.	MATERIAL	FINISH . REMARKS

UNITS mm		SCALE 5 : 1	COUNT 	DESCRIPTION OF REVISIONS	DESIGNED	CHECKED	DATE
HIROSE ELECTRIC CO., LTD.				APPROVED : KY. SHIMIZU 16.07.08 CHECKED : KY. SHIMIZU 16.07.08 DESIGNED : MH. OGUSU 16.07.08 DRAWN : MH. OGUSU 16.07.08	DRAWING NO. EDC-366798-00-00 PART NO. HRMP-SMA(R)J CODE NO. CL323-0036-0-00		