

**COAXIAL, HIGH VOLTAGE, AND HIGH POWER CONTACTS (for D\*M)**

**Straight Solder Type Coaxial Contacts**

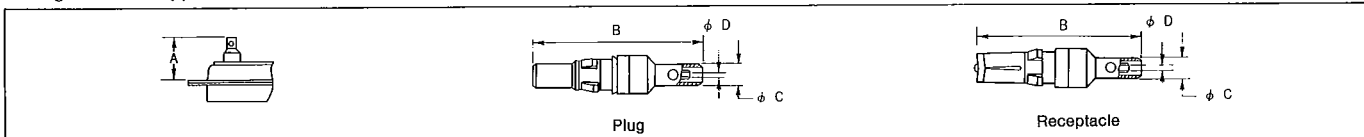

Connector Type	Part Number	A Max.	B Ref.	phi C ±.012 (±0.3)	phi D ±.008 (±0.2)	Applicable Cable No.		Military Finish (Special)
						Old	New	
Plug	DM53740-5008	.740 (18.8)	.929 (23.6)	.118 (3.0)	.055 (1.4)	196/U	178B/U	DM53740-5015
Plug	DM53740-5001	.740 (18.8)	.929 (23.6)	.154 (3.9)	.083 (2.1)	187/U 188/U	179B/U 316B/U	DM53740-5099
Plug	DM53740-5002	.846 (21.5)	1.035 (26.3)	.236 (6.0)	.142 (3.6)	145/U	180B/U	D53740-5104
Plug	DM53740-5005	.846 (21.5)	1.035 (26.3)	.236 (6.0)	.142 (3.6)	58/U	58B/U	DM53740-5101
Receptacle	DM53742-5006	.740 (18.8)	.929 (23.6)	.154 (3.9)	.055 (1.4)	196/U	178B/U	DM53742-5092
Receptacle	DM53742-5001	.740 (18.8)	.929 (23.6)	.154 (3.9)	.083 (2.1)	187/U 188/U	179B/U 316B/U	DM53742-5089
Receptacle	DM53742-5002	.846 (21.5)	1.035 (26.3)	.236 (6.0)	.142 (3.6)	195/U	180B/U	DM53742-5091
Receptacle	DM53742-5004	.846 (21.5)	1.035 (26.3)	.236 (6.0)	.142 (3.6)	58/U	58B/U	DM53742-5086
Plug (Short Type)	DM53742-5000	.669 (17.0)	.858 (21.8)	.118 (3.0)	.055 (1.4)	196/U	178B/U	DM53740-5100
Receptacle (Short Type)	DM53742-5000	.669 (17.0)	.858 (21.8)	.118 (3.0)	.055 (1.4)	196/U	178B/U	DM53740-5085

**Right Angle Solder Type Coaxial Contacts**

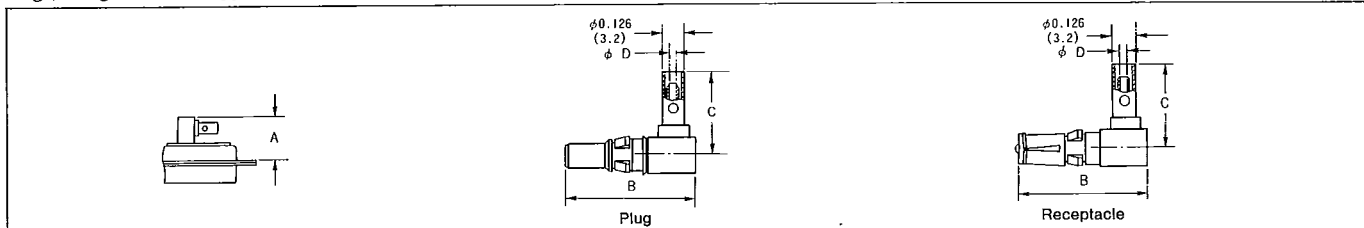

Contact Type	Part Number	A Max.	B Ref.	C Ref.	phi D ±.008 (±0.2)	Applicable Cable No.		Military Finish (Special)
						Old	New	
Plug	DM53741-5000	.531 (13.5)	.732 (18.6)	.492 (12.5)	.055 (1.4)	196/U	178B/U	DM53741-5059
Receptacle	DM53743-5000	.531 (13.5)	.732 (18.6)	.492 (12.5)	.055 (1.4)	196/U	178B/U	DM53743-5073

**Straight High Voltage Contacts**

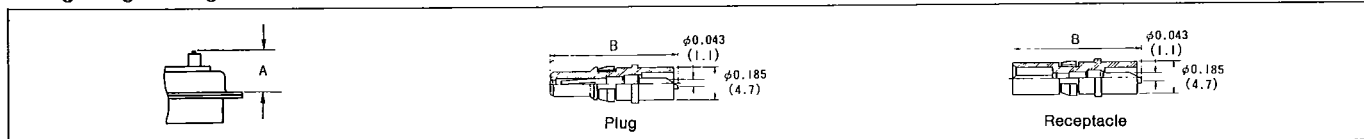

Contact Type	Part Number	A Max.	B Ref.	Applicable Wire		Military Finish (Special)
				Size	Conductor dia.	
Plug	DM51157	.539 (13.7)	.732 (18.6)	#20	.032 (0.812)	DM51167-8
Receptacle	DM51155	.539 (13.7)	.732 (18.6)	#20	.032 (0.812)	DM51155-7

**Solder Type High Power Contacts**

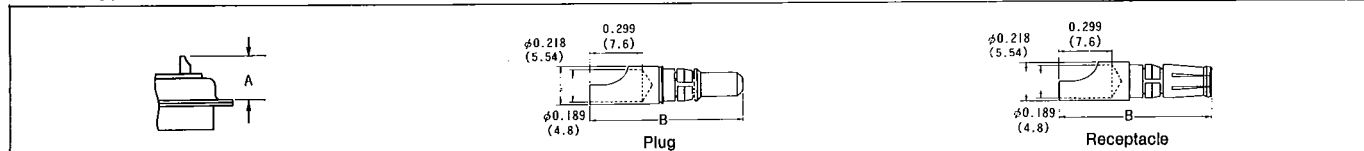

Contact Type	Part Number	A Max.	B Ref.	Current Rating (amp)	Applicable Wire		Military Finish (Special)
					Size	Conductor dia.	
Plug	DM53745-1	.665 (16.9)	.866 (22.0)	40	#8	.129 (3.264)	DM53745-28
Receptacle	DM53744-1	.665 (16.9)	.854 (21.7)	40	#8	.129 (3.264)	DM53744-21

**COAXIAL, HIGH VOLTAGE, AND HIGH POWER CONTACTS**

**Type of Contacts**

- Coaxial contacts (Plug and receptacle, solder type)
- High voltage contacts (Plug and receptacle, solder type)
- High power contacts (Plug and receptacle, solder type)
- For all types above, contacts are inserted into the contact cavities in the insulator after being terminated to wire.
- For terminating and assembling methods, see page 66.)

**Combination of Connector and Contacts**

Use plug type coaxial contacts in receptacle connectors with pins (i.e., size No. 20 standard male contacts), such as DBM-13W3P, and receptacle type coaxial contacts in plug connectors with standard No. 20 socket contacts, such as DBM-13W3S.

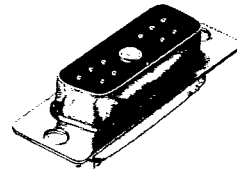

Pin connector

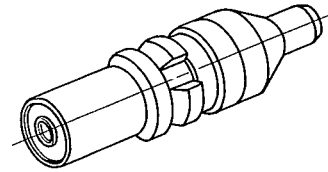

Plug type contact (with center contact being female and outer male)

**Combination of Contacts**

For each type of contact above, there are a variety of plugs and receptacles, enabling various combinations of connectors to use the same type contacts.

Example: In case of straight coaxial contacts, solder type:

Plug	Receptacle
DM53740	DM53742-5001

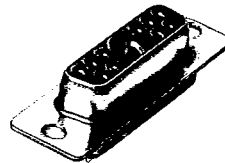

Socket connector

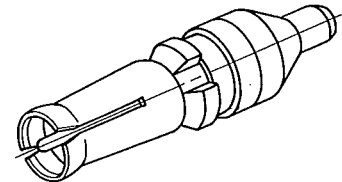

Receptacle type contact (with center contact being male and outer female)

**Mated coaxial contacts (DM53740-5008 ↔ DM53742-5006)**

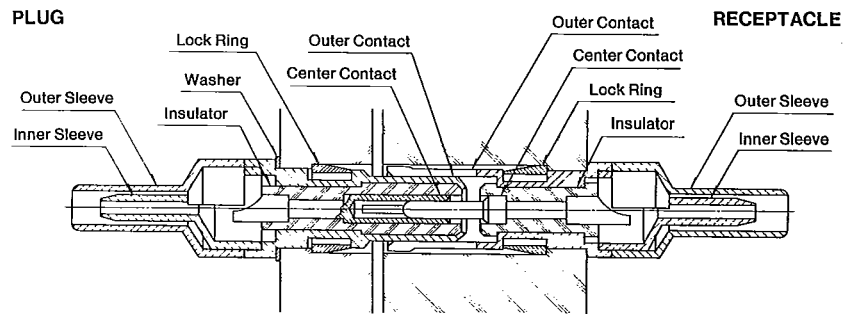

**STANDARD DATA**

**Materials and Finishes**

**High Power Contacts**

Components	Contact		Lock Ring
	Plug	Receptacle	
Material	Copper Alloy		Copper Alloy
Finish	Gold Plate		Gold Plate

**Coaxial Contacts**

Components	Outer Contact		Inner Contact		Outer/Inner Sleeves	Washer	Insulator	Lock Ring
	Plug	Receptacle	Plug	Receptacle				
Material	Copper Alloy						Teflon	Copper Alloy
Finish	Gold Plate						-	Silver Plate

**High Voltage Contacts**

Components	Contact		Insulator		Lock Ring
	Plug	Receptacle	Plug	Receptacle	
Material	Copper Alloy		Nylon		Copper Alloy
Finish	Gold Plate		Color: Red	Color: Blue	Silver Plate

**Dielectric Rating (#20 contact, inserts for coaxial and high voltage contacts)**

Altitude		Sea Level				20,000 feet				50,000 feet				70,000 feet			
		90° Straight		90° Straight		90° Straight		90° Straight		90° Straight		90° Straight		90° Straight			
Center Conductor to Coaxial Shell	Average Flashover Voltage	1200	1500	900	1000	600	700	400	500								
	Test Voltage	800	1000	600	650	400	475	275	325								
Coaxial Shell to Plug Shell	Average Flashover Voltage	1500	1500	1000	1000	500	500	500	500								
	Test Voltage	1000	1000	650	650	325	325	325	325								
Coaxial Shell to Nearest AWG #20 Contact	Average Flashover Voltage	-	1500	-	1500	-	900	-	650								
	Test Voltage	-	1000	-	1000	-	600	-	425								
H.V. Contact to Nearest Contact or to Shell	Average Flashover Voltage	3800	3800	2300	2300	900	900	650	650								
	Test Voltage	2800	2800	1700	1700	675	675	475	475								

**SOLDER TYPE**

**D\*M Type**

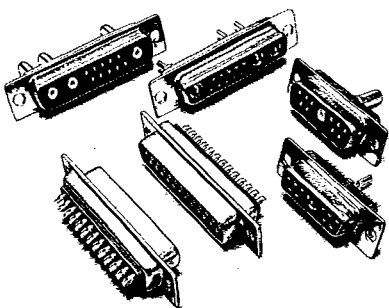

**FEATURES**

• **High reliability, rugged construction**

The insulator is a mono-block type molded of glass-filled diallyl phthalate which excels in heat and environmental resistance, dimensional stability, etc. A beryllium copper spring member is used in the socket contact to assure contact stability and reliability.

• **Broad lineup of contact layouts**

In addition to standard solder type contacts (size No. 20, rated current 5 A), special contacts such as coaxial, high-voltage, and high-current types are available. Special mixed-content layouts combining these contacts are also available, in addition to the basic layouts for 9 to 50 conductors. The special contacts are ordered separately (shown on pages 27 and 28).

• As specified by RS-232 and JIS C-6361, the Interface between Data Circuit Terminating Equipment (DCE) and Data Terminal Equipment (DTE) is a 25-position D Subminiature connector, as used in data communication and other equipment.

• **Wire connection by soldering**

Use standard wire under 20 AWG. The capacity of the soldering iron must be between 40 and 60 W. Install special contacts in the insulator after being terminated.

• **Connector mating combinations**

Mate connectors that have the same shell sizes and contact layouts but different contact sex.

Example: (a) DAM-15P (15 conductors, male pin side) combined with DAM-15S (15 conductors, female socket side)

(b) DBM-17W2P (17 conductors, pin side, with two special contact cavities) combined with DBM-17W2S (17 conductors, socket side, with two special contact cavities)

**HOW TO ORDER**

**DBM -25 P**  
**DBMF-13W3S**  
**DBM -25 S-0001**

- Modification codes (see Note 2)
- Contact type: P... Pin, S... Socket  
9, 15, 25, 37, 50 and special
- Contact arrangements: arrangements (see Note 1)  
No designator... Standard
- Mounting type: F... Float Mount (rear mounting)
- Connector type: M... Monoblock Insulator
- Shell size: E, A, B, C, D
- Series prefix

**Notes: (1) Special contact arrangements**

- a) Those contact arrangements having "W" in between such as "13W3" mean that the insulator has cavities for coaxial, high voltage, and/or high power contacts. For example, "13W3" means that of the 13 contacts, three are special and the remaining ten are standard.
- b) Connectors come without special contacts. Refer to page 27 and 28, and order separately.

**(2) Modification code -0001**

- a) Means two pieces of jack screws (P/N D20418-J2) are mounted. Applies to DBM-25S only.
- b) DBM-25S-0001 is a receptacle meeting the requirements of JIS-C-6361.

**CONTACT ARRANGEMENTS**

See page 26.

**STANDARD DATA**

• **Materials/Finishes**

Component	Material	Finish
Contact	Copper alloy (Socket contact spring — Beryllium copper)	Gold plate
Lock ring	Beryllium copper	Gold plate
Insulator	Glass-filled diallylphthalate	Color: Dark green
Shell	Steel	Yellow chromate over zinc plate

• **Electrical Data**

Current Rating	5 amp
Dielectric Rating	1,250 VAC r.m.s
Insulation Resistance	5,000 megohms min.
Contact Resistance	2.7 milliohms max. (Voltage drop method)

- For details, see pages 6 and 7.
- For terminating and assembling methods, see pages 62 thru 66.

**FEATURES**

• **Five different shell sizes and numbers of conductors**

The connector housing is compact and rectangular. The contacts and insulators are contained in a rugged steel shell. There are five shell sizes (E, A, B, C, and D), respectively with standard contact counts of 9, 15, 25, 37, and 50. Special layouts to accept coaxial, high-voltage, and high-current contacts are also available.

E	A	Shell Size:
9	15	Number of Conductors:

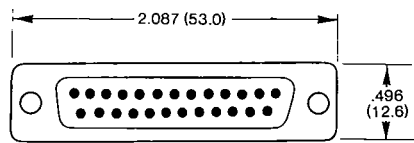
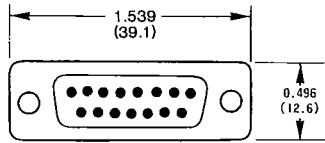
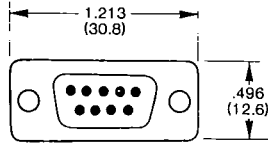

B	Shell Size:
25	Number of Conductors:

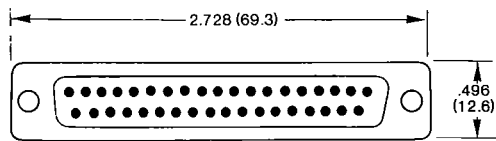

C	Shell Size:
37	Number of Conductors:

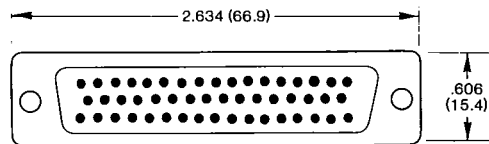

D	Shell Size:
50	Number of Conductors:

**Special Layouts (D\*M Type)**



• **Fail-Safe Polarizing Mechanism**

The shell connecting part is keystone trapezoidal which inherently prevents incorrect coupling.

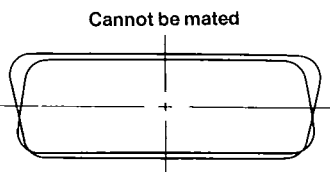
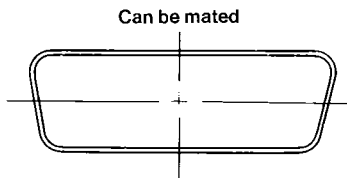

• **Official Standards**

D Sub connectors conform to many international standards including:

- Japan Industrial Standards
  - JIS-C-6361
  - JIS-C-6366
  - JIS-C-6367
- Japan Defense Agency Standards
  - NDSXC 6116
  - DSP C 6242
- US Military Standards
  - MIL-C-24308

• **Shell Type**

The shell profile comes in a panel-mounting standard type and floating type (the latter aids in rack-to-panel connection).

A-17-03  
A-17-05  
A-61-11  
A-65-07

**Standard Type**

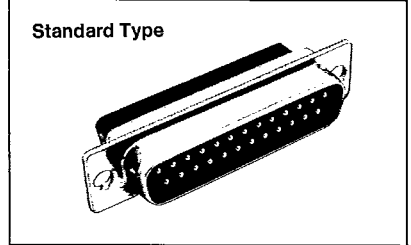

**Floating Type**

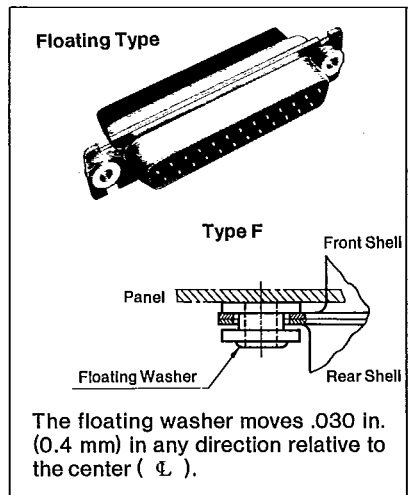

The floating washer moves .030 in. (0.4 mm) in any direction relative to the center (⌀).

• **Close Entry Construction**

Socket insulators have a closed entry construction which prevents entry of oversized contacts or probes.

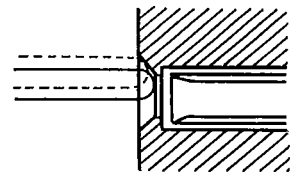

• **Compatibility**

Individual connector types are interchangeable as are the accessories.

■ General Specification (Principal Performance)

Division	Item	Performance						
		D *		D * M	D * U			
		Stamped Contacts	Machined Contacts		Stamped Contacts		Machined	
Electrical Performance	Rated Current	5A						
	Dielectric Strength (See Level)	AC 1250 V r.m.s			AC 1000 V r.m.s			
	Insulation Resistance	5000 M-ohm or greater						
	Contact Resistance	2.7 m-ohm or less (5.0 m-ohm or less after the life and after salt spray). Test current: AWG No. 20, 7.5 a; AWG No. 22, 5; AWG No. 24, 3. *Through hole (PCB mounted connectors not applicable).						
Mechanical Performance	Contact Force	Mating force: 28.4 ~ 408 g Unmating force: 28.4 ~ 272 g	Mating force: 28.4 ~ 340 g Unmating force: 28.4 ~ 227 g	Mating force: 28.4 ~ 408 g Unmating force: 28.4 ~ 272 g				
	Connector Mating/Unmating Force	Mating force: (408 g × number of contacts) or less. Unmating force: (272 g × number of contacts) or less.	Mating force: (340 g × number of contacts) or less. Unmating force: (227 g × number of contacts) or less.	kg or less	Stamped Contact		Machined	
					Mating Force	Unmating Force	Mating Force	
					9	3.7	2.4	3.1
					15	6.1	4.1	5.1
25	10.2	6.8	8.5					
37	15.1	10.1	12.6					
50	20.4	13.6	17.0					
Contact Retention Force (kg or larger)	D *		D * M	D * U				
	Stamped Contacts	Machined Contacts		Stamped Contacts		Machined		
	4.5		4.1	3.6		4.5		
Vibrations	(1) The current (discontinuity) shall not exceed one (1) microsecond. (2) Shall pass the dielectric strength test at sea level. (3) Parts shall be free of cracks, damage, and looseness.							

A-17-03  
 A-17-05  
 A-61-11  
 A-65-07

■ General Specification (Principal Performance)

Division	Item	Performance			
		D*		D* M	Stamped Contact
		Stamped Contact	Machined Contact		
Mechanical Performance	Contact Retention Force (kg or larger)	4.5		4.1	3.6
	Shock	(1) Current discontinuity may not exceed one (1) microsecond during the test. (2) Shall pass the dielectric strength test at sea level. (3) Parts shall be free of cracks, damage, and looseness.			
	Life	(1) Contact resistance 5 m-ohm or less. (D* SP: 30 m-ohm or less.) (2) Contact mating/unmating force Refer to the previous section. (3) Connector mating/unmating force			
Environmental Performance	Temperature Cycle		D*	D* M	
		Low Temperature	-67°F (-55°C)	-85°F (-65°C)	
		High Temperature	+257°F (+125°C)	+302°F (+150°C)	
		(1) The connector shall be free of cracks and damage. (2) Shall pass the dielectric strength test at sea level.			
	Humidity Resistance	Immediately after test (1) Insulation resistance: 1 M-ohm or higher. (2) Dielectric strength: 600 VAC rms or higher. (D* SP: 400 VAC rms or higher.) After storing for 24 hours (1) Insulation resistance: 1000 M-ohm or higher.			
Corrosion	(1) There shall be no detrimental corrosion that affects the base metal and connector (2) Contact resistance: 5 m-ohm or less. (D* SP: 30 m-ohm or less.)				