

VL CONNECTOR

Disconnectable Crimp style connectors

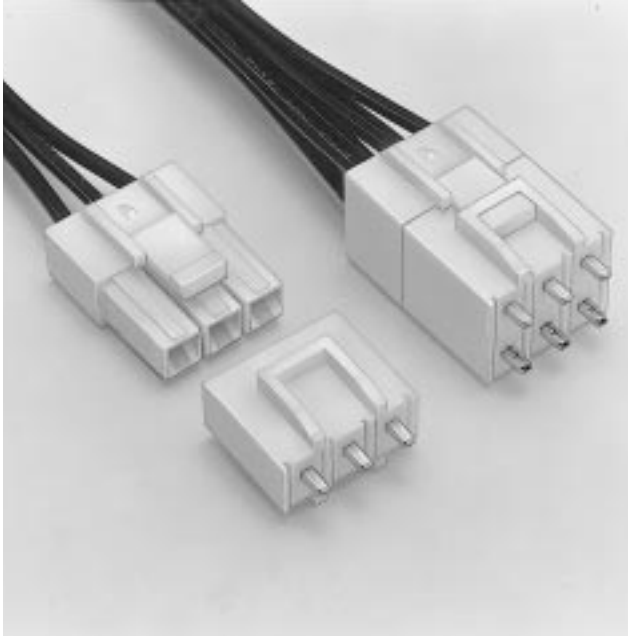

This 6.2mm (.244") pitch wire-to-board connector is designed for circuits with high power requirements.

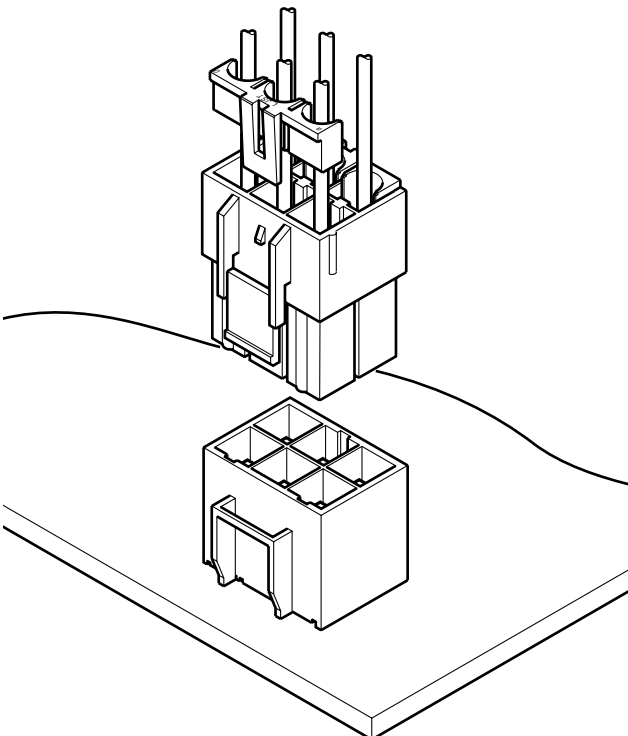

Features

• Housing lances for contact retention

Since the contact retention lances are part of the housing rather than protruding from the contact, they cannot be damaged by handling. They allow the contact to be easily inserted and securely locked into the housing.

• Secondary retainer

The secondary retainer is optionally available. This retainer ensures that the contacts are fully seated and locked in the housing and prevents their accidental release. Installed after the contacts are inserted, the secondary retainer locks and secures the contacts.

• Suited for circuits with high power requirements

Since these contacts have large cross-sectional areas and high contact pressure, they can accommodate circuits requiring high power.

• Inter-housing lock

The inter-housing lock secures the plug to the receptacle and prevents accidental disconnection. The lock is protected and is not affected by external forces that might result from the routing of wires during assembly.

• Two kinds of connections

The VL connectors can be used for wire-to-wire or wire-to-board connections.

Specifications

- Current rating: 20.0A AC, DC
 - Voltage rating: 600V AC, DC
 - Temperature range: -25°C to +90°C
(including temperature rise in applying electrical current)
 - Contact resistance: Initial value/7mΩ max.
After environmental testing/10mΩ max.
 - Insulation resistance: 1,000MΩ min.
 - Withstanding voltage: 1,500V AC/minute
 - Applicable wire: AWG #20 to #12
 - Applicable PC board thickness: 1.6mm(.063")
- * Contact JST for details.

Note:

The current rating differs depending on the number of circuits and the wire size used in each connector. The table below lists the current rating as a function of the number of circuits and the wire size.

Current unit:A

Circuits	Wire size(AWG)				
	#12	#14	#16	#18	#20
*2(3)	20	15	10	8	6
3	17	14	9	8	6
4	16	13	9	7	6
6	15	12	8	7	5

Note:

Do not branch in parallel current which exceeds the rated current (eg. more than 17A in the case of 3 circuits with AWG #12). If branched in parallel, current imbalance or other problems may develop. If it is absolutely necessary to branch such a large current in parallel, design the circuits without causing any imbalance and provide an extra margin for each circuit.

Standards

Recognized file No. E60389

Certified file No. LR20812

File No. R9351103(conforms to DIN/VDE 0627)

VL CONNECTOR

Contact

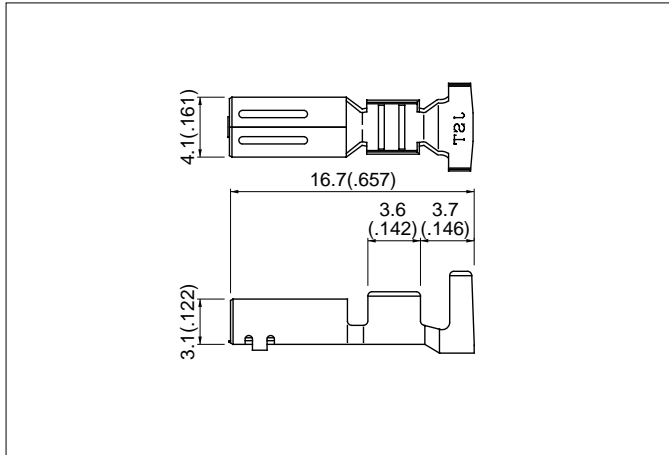

Model No.	Applicable wire			Q'ty / reel
	mm ²	AWG #	Insulation O.D. mm(in.)	
SVF-42T-P2.0	0.3 to 1.25	22 to 16	1.7 to 3.2(.067 to .126)	2,000
SVF-61T-P2.0	0.5 to 2.0	20 to 14	1.9 to 3.4(.075 to .134)	2,000
SVF-81T-P2.0	3.5	12	4.1(.161)	2,000

Material and Finish
Phosphor bronze, Tin-plated

Note: SVF-42T-P2.0 is not TÜV approved.

Housing

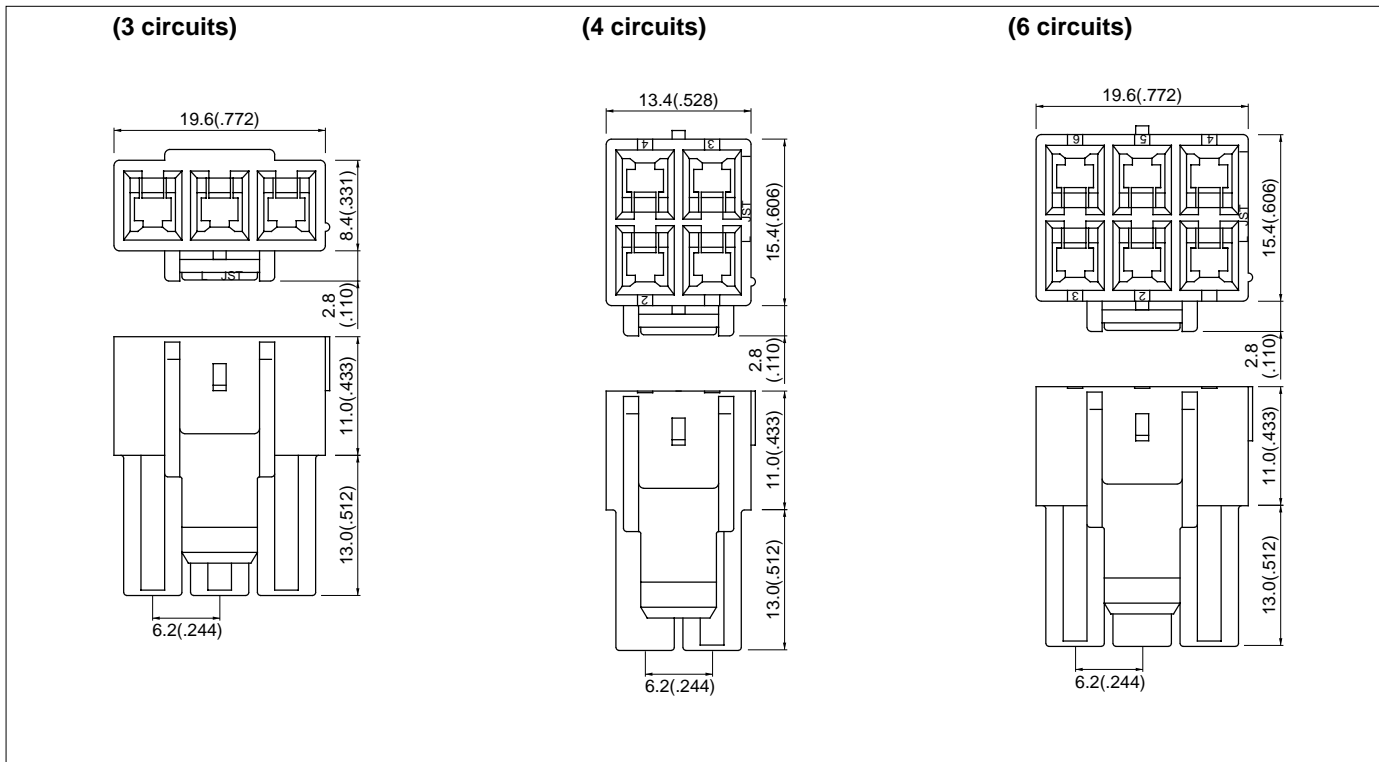

Circuits	Model No.	Q'ty / bag
3	VLP-03V	500
4	VLP-04V	500
6	VLP-06V	500

Material
Nylon 66, UL94V-0, white

Nylon 66, UL94V-0, white

Retainer

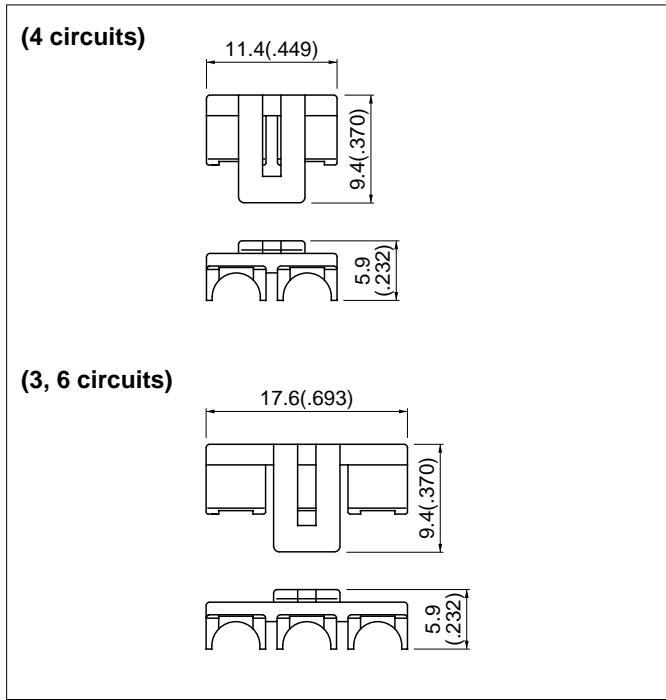

Cir-cuits	Model No.	Q'ty / bag
4	VLS-02V	1,000
3,6	VLS-03V	1,000

Material	
Glass-filled nylon 66, UL94V-0	

Shrouded header

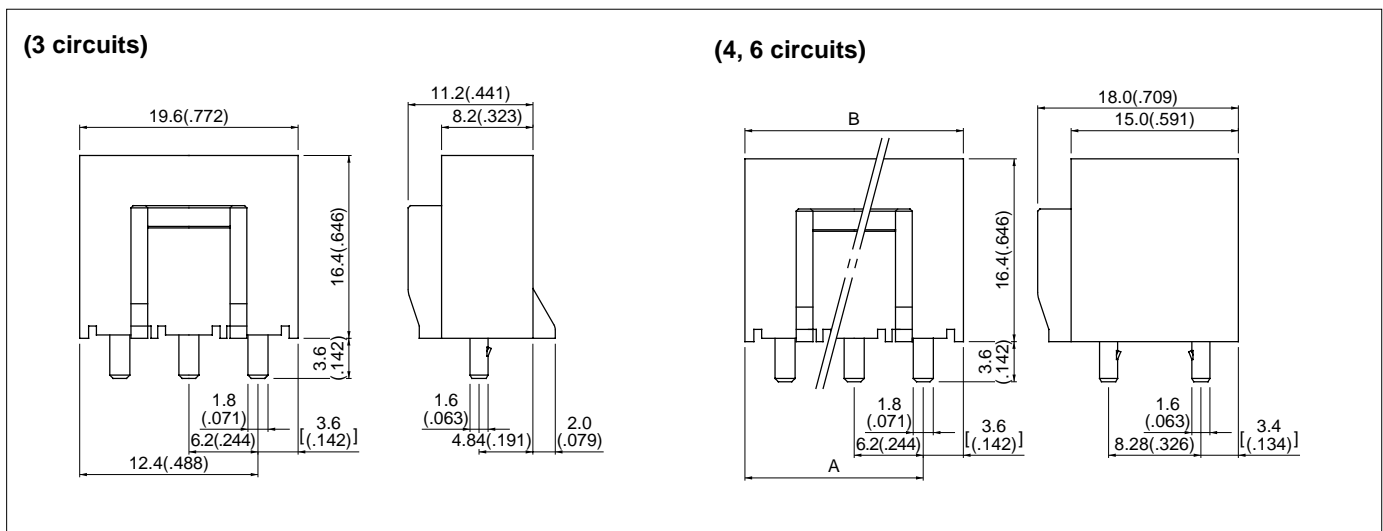

Cir-cuits	Model No.	Dimensions mm(in.)		Q'ty / box
		A	B	
3	B03P-VL	-	-	100
4	B04P-VL	6.2(.244)	13.4(.528)	100
6	B06P-VL	12.4(.488)	19.6(.772)	50

Material	
----------	--

Post: Phosphor bronze, tin-plated
 Wafer: Nylon 66, UL94V-0, white

VL CONNECTOR

Contact position location numbers

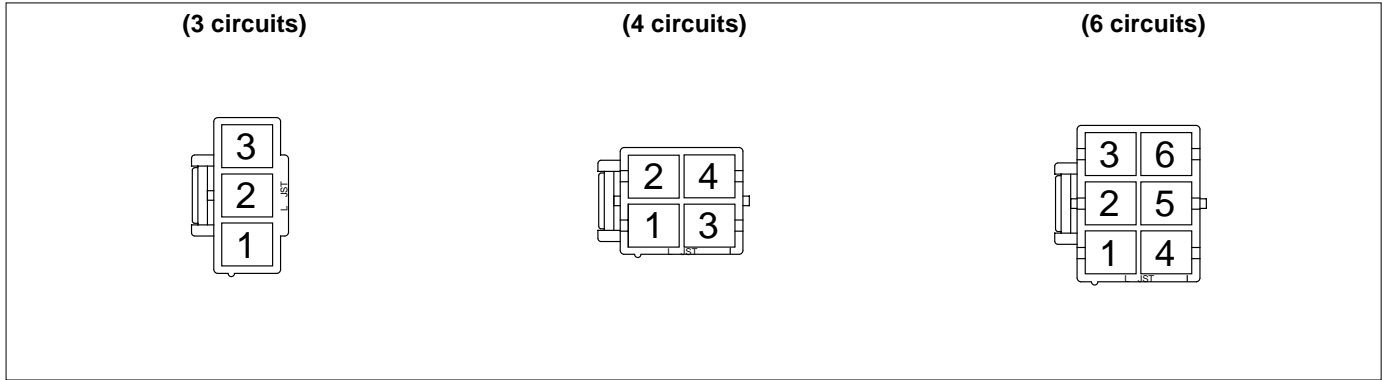

PC board layout (viewed from soldering side)

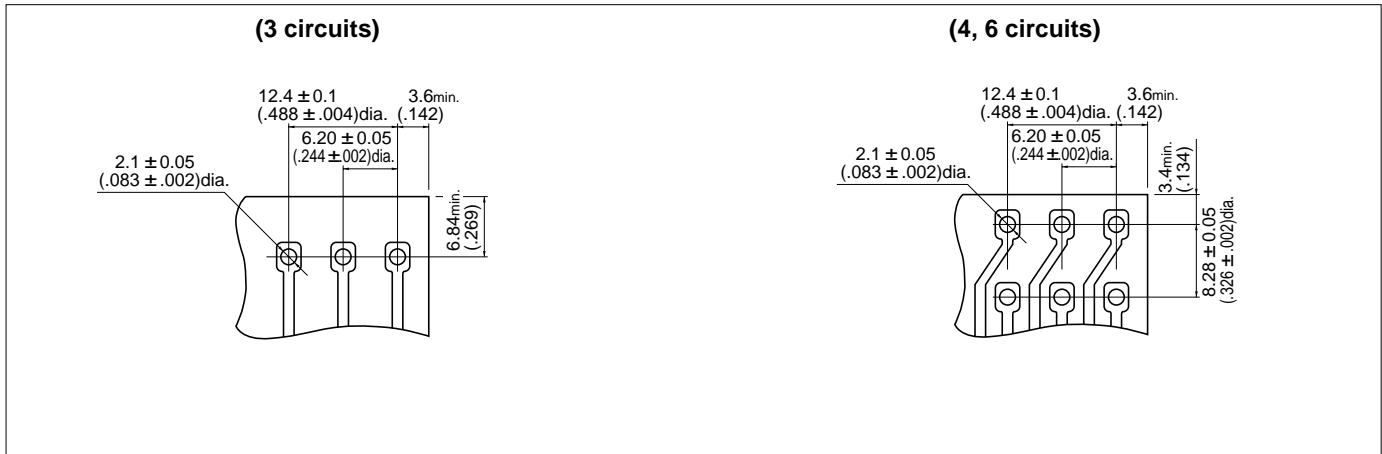

Note:
 1. Tolerances are non-cumulative: $\pm 0.05\text{mm} (\pm .002")$ for all centers.
 2. Hole dimensions differ according to the kind of PC board and piercing method. The dimensions above should serve as a guideline. Contact JST for details.

Assembly layout

