

A700, Polymer Aluminum, 125C, 22 uF, 20%, 8 VDC, -55/+125C, Height Max = 2mm

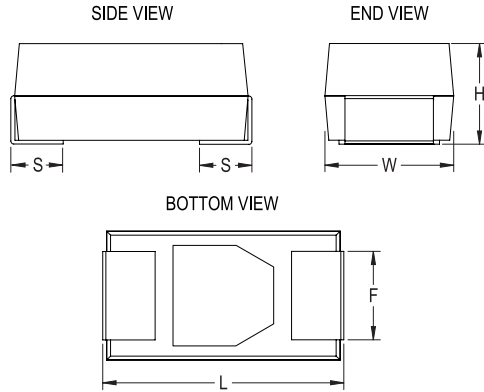

Dimensions	
L	7.3mm +/-0.3mm
W	4.3mm +/-0.3mm
H	2mm MAX
S	1.3mm +/-0.3mm
F	2.4mm +/-0.1mm

Packaging Specifications	
Weight:	132.72 mg
Packaging:	T&R, 180mm
Packaging Quantity:	1000

General Information	
Supplier:	KEMET
Series:	A700
Dielectric:	Polymer Aluminum
Style:	SMD Chip
Description:	Surface Mount, Polymer Aluminum
RoHS:	Yes
Termination:	Tin
Notes:	V/7343-20
Footprint:	7343
Shelf Life:	104 Weeks
MSL:	3

Specifications	
Capacitance:	22 uF
Capacitance Tolerance:	20%
Voltage DC:	8 VDC
Temperature Range:	-55/+125C
Rated Temperature:	125C
Dissipation Factor:	6.00%
Resistance:	28 mOhms (100kHz 25C)
Ripple Current:	3100 mAmps (100kHz)
Leakage Current:	7.04 uA (5min 25C)