

Overview

KEMET's **KPS Series (KEMET Power Solutions)** utilizes proprietary lead-frame technology to vertically stack one or two multilayer ceramic chip capacitors (MLCCs) into a single compact surface mount package. The attached lead-frame mechanically isolates the capacitor/s from the printed circuit board, therefore offering advanced mechanical and thermal stress performance. Isolation also addresses concerns for audible, microphonic noise that may occur when a bias voltage is applied.

A two chip stack offers up to double the capacitance in the same or smaller design footprint when compared to traditional surface mount MLCC devices.

Providing up to 10mm of board flex capability, KPS Series capacitors are environmentally friendly and in compliance with RoHS legislation. Available in X7R dielectric, these devices are capable of Pb-free reflow profiles and provide lower ESR, ESL and higher ripple current capability when compared to other dielectric solutions.

Benefits

- Higher capacitance in the same footprint
- Potential board space savings.
- Advanced protection against thermal and mechanical stress
- Provides up to 10mm of board flex capability
- Reduces audible, microphonic noise
- Extremely low ESR and ESL
- Pb-Free and RoHS compliant
- Capable of Pb-Free reflow profiles
- Non-polar device, minimizing installation concerns
- Automotive grade (AEC-Q200) under development.

Applications

- Industrial, Automotive, Military, Telecom
- Smoothing circuits
- DC-to-DC converters
- Power supplies (input/output filters)
- Noise Reduction (piezoelectric / mechanical)
- Circuits with a direct battery or power source connection.
- Critical and safety relevant circuits without (integrated) current limitation.
- Any application that is subject to high levels of board flexure or temperature cycling

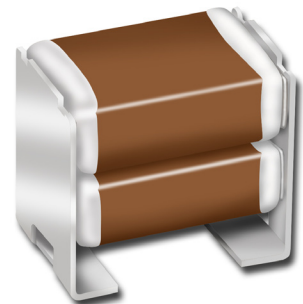

Ordering Information

C	2220	C	106	M	5	R	2	C	TU
Ceramic	Case Size (L" x W")	Specification/ Series	Capacitance Code (pF)	Capacitance Tolerance ¹	Voltage	Dielectric	Failure Rate/Design	End Metallization ²	Packaging/Grade (C-Spec) ³
	1210 1812 2220	C = Standard	2 Sig. Digits + Number of Zeros	K = ±10% M = ±20%	8 = 10V 4 = 16V 3 = 25V 5 = 50V 1 = 100V A = 250V	R = X7R	1 = KPS Single Chip Stack 2 = KPS Double Chip Stack	C = 100% Matte Sn	TU = 7" Reel Unmarked 7289 = 13" Reel Unmarked

¹ Double chip stacks ("2" in the 13th character position of the ordering code) are only available in M (±20%) capacitance tolerance. Single chip stacks ("1" in the 13th character position of the ordering code) are available in K (±10%) or M (±20%) tolerances.

² Additional termination options may be available. Contact KEMET for details.

³ Additional reeling or packaging options may be available. Contact KEMET for details.

Dimensions – Millimeters (Inches)

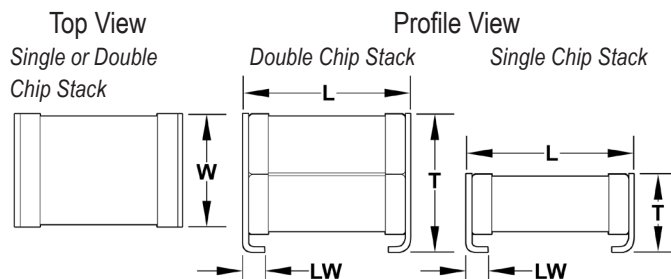

Chip Stack	EIA Size Code	Metric Size Code	L Length	W Width	T Thickness	LW Lead Width	Mounting Technique
Single	1210	3225	3.50 (.138) ± 0.30 (.012)	2.60 (.102) ± 0.30 (.012)	3.35 (.132) ± 0.10 (.004)	0.80 (.032) ± 0.15 (.006)	Solder Reflow
	1812	4532	5.00 (.197) ± 0.50 (.020)	3.50 (.138) ± 0.50 (.020)	2.65 (.104) ± 0.35 (.014)	1.10 (.043) ± 0.30 (.012)	
	2220	5650	6.00 (.236) ± 0.50 (.020)	5.00 (.197) ± 0.50 (.020)	3.50 (.138) ± 0.30 (.012)	1.60 (.063) ± 0.30 (.012)	
Double	1210	3225	3.50 (.138) ± 0.30 (.012)	2.60 (.102) ± 0.30 (.012)	6.15 (.242) ± 0.15 (.006)	0.80 (.031) ± 0.15 (.006)	
	1812	4532	5.00 (.197) ± 0.50 (.020)	3.50 (.138) ± 0.50 (.020)	5.00 (.197) ± 0.50 (.020)	1.10 (.043) ± 0.30 (.012)	
	2220	5650	6.00 (.236) ± 0.50 (.020)	5.00 (.197) ± 0.50 (.020)	5.00 (.197) ± 0.50 (.020)	1.60 (.063) ± 0.30 (.012)	

Outline Drawing

Ref	Name	Material
A	Leadframe	Phosphor Bronze - Alloy 510
B	Leadframe Attach	High Temp Solder
C	Termination	Cu
D		Ni
E		Sn
F	Electrode	Ni
G	Dielectric	BaTiO ₃

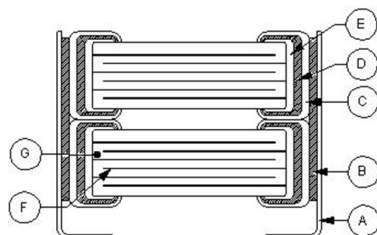

Qualification/Certification

Commercial grade products meet or exceed the performance and reliability standards outlined in Table 4 - Performance and Reliability of this specification.

Environmental Compliance

RoHS PRC (Peoples Republic of China) compliant

Electrical Parameters/Characteristics

Operating Temperature Range:	-55°C to +125°C
Capacitance Change with Reference to +25°C and 0 Vdc Applied (TCC):	±15%
Aging Rate (Max % Cap Loss/Decade Hour):	3.5%
Dielectric Withstanding Voltage:	250% of rated voltage (5 ± 1 seconds and charge/discharge not exceeding 50mA)
Dissipation Factor (DF) Maximum Limits @ 25°C:	5% (10V), 3.5% (16V & 25V) and 2.5% (50V to 200V)
Insulation Resistance (IR) Limit @ 25°C:	See Insulation Resistance Limit Table page 3

To obtain IR limit, divide MΩ-μF value by the capacitance and compare to GΩ limit. Select the lower of the two limits.

Capacitance and Dissipation Factor (DF) measured under the following conditions:

1kHz ± 50Hz and 1.0 ± 0.2 Vrms if capacitance ≤ 10μF

120Hz ± 10Hz and 0.5 ± 0.1 Vrms if capacitance > 10μF

Insulation Resistance Limit Table

EIA Case Size	1000 megohm microfarads or 100Ω	500 megohm microfarads or 10GΩ
1210	< 0.39μF	≥ 0.39μF
1812	< 2.2μF	≥ 2.2μF
2220	< 10μF	≥ 10μF

Electrical Characteristics

Z and ESR C1210C475M5R1C

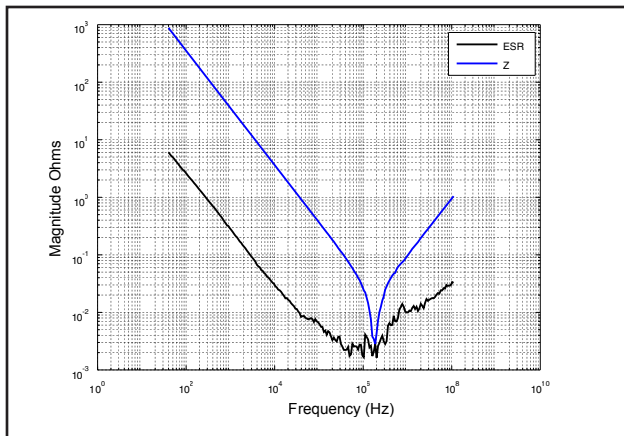

Z and ESR C2220C225MAR2C

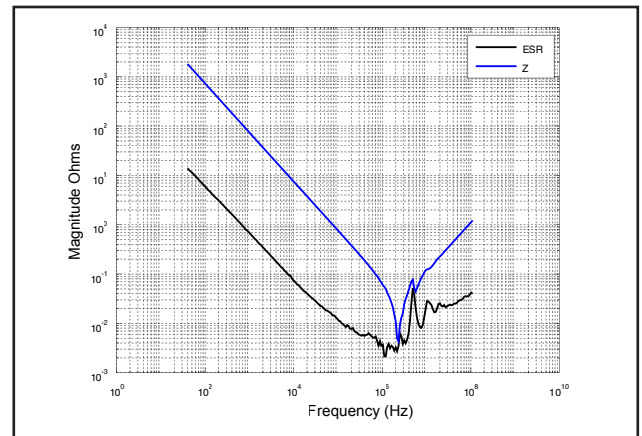

Z and ESR C2220C476M3R2C

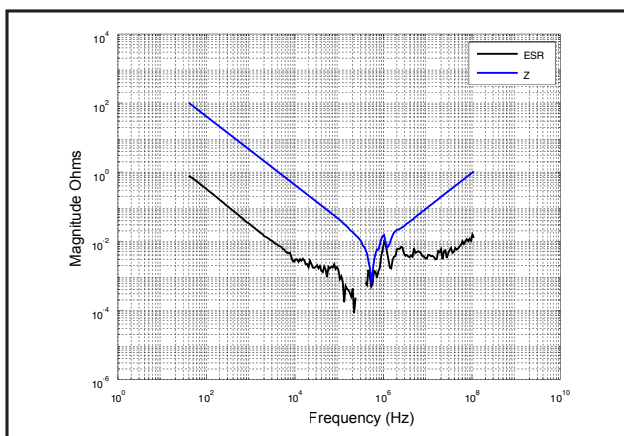

Electrical Characteristics con't

ESR - 1812, .10 μ F, 50V X7R

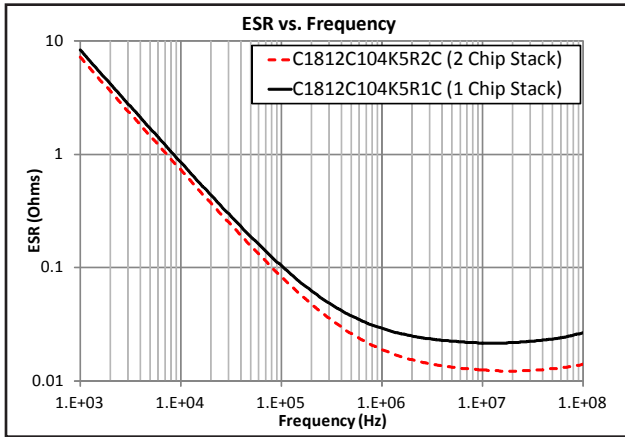

Impedance - 1812, .10 μ F, 50V X7R

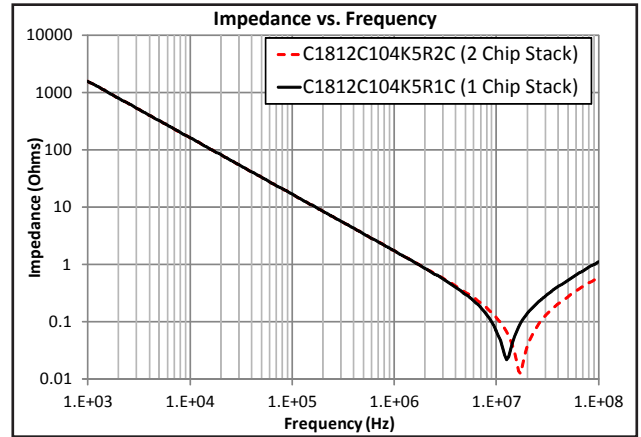

ESR - 1210, .22 μ F, 50V X7R

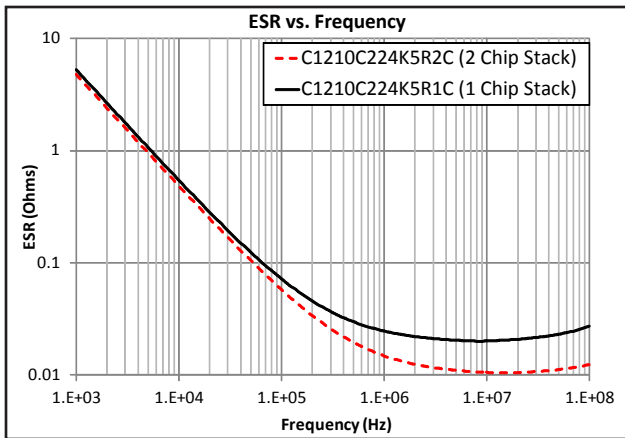

Impedance - 1210, .22 μ F, 50V X7R

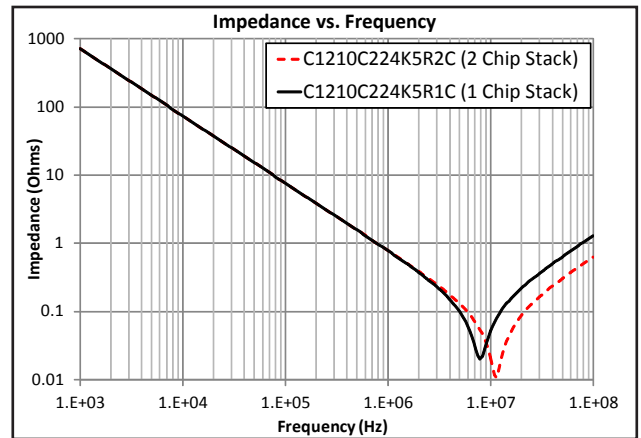

Electrical Characteristics con't

Microphonics - 1210, 4.7 μ F, 50V, X7R

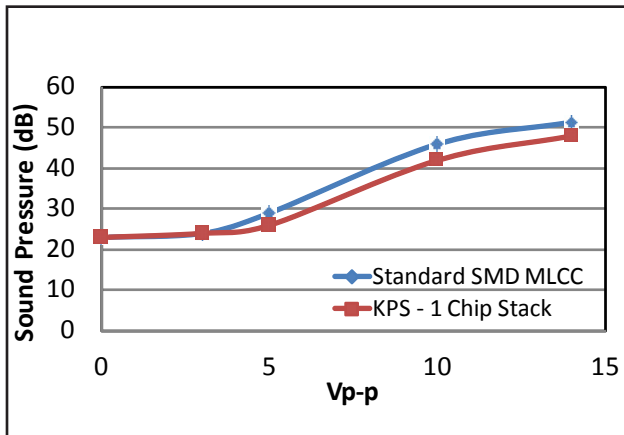

Microphonics - 2220, 22 μ F, 50V, X7R

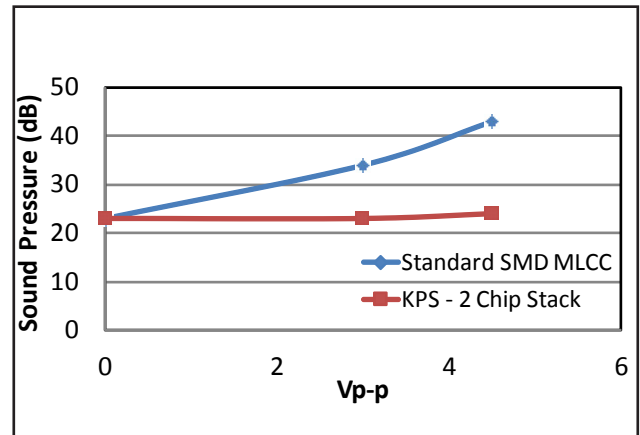

Microphonics - 2220, 47 μ F, 25V, X7R

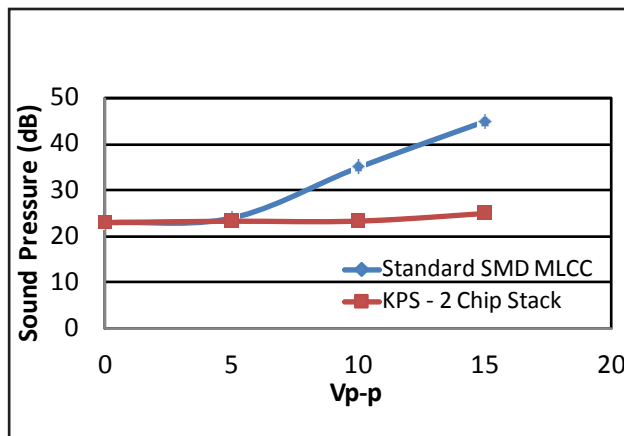

Microphonics - 1210, 22 μ F, 25V, X7R

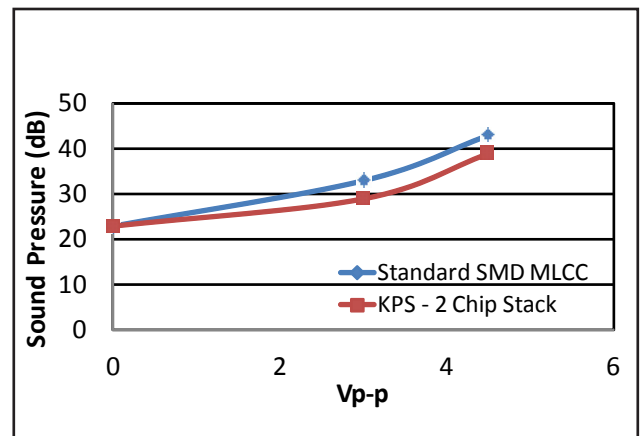

Competitive Comparison

Microphonics - 1210, 4.7 μ F, 50V, X7R

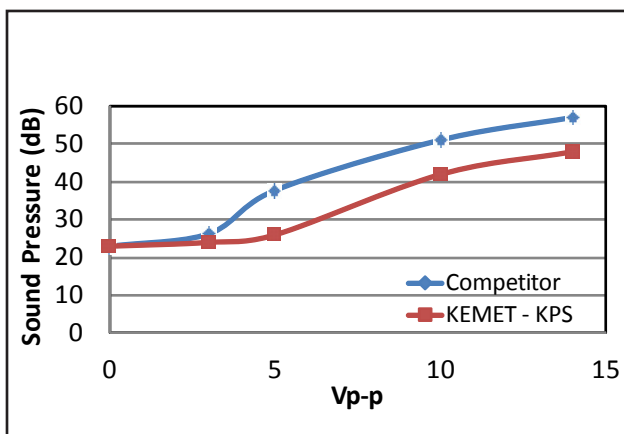

Ripple Current (Arms) 2220, 22 μ F, 50V

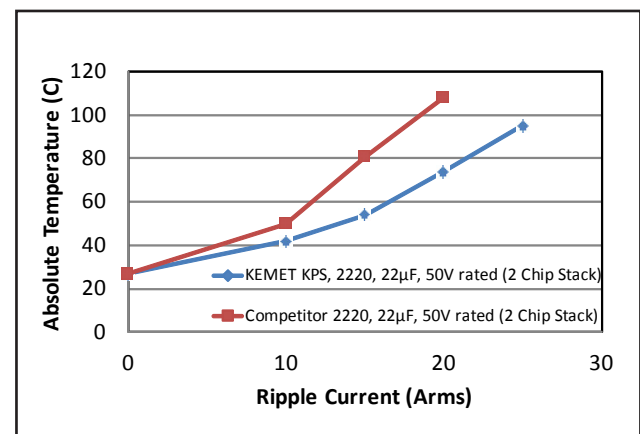

Note: Refer to Table 4 for test method.

Electrical Characteristics con't

Board Flex vs. Termination Type

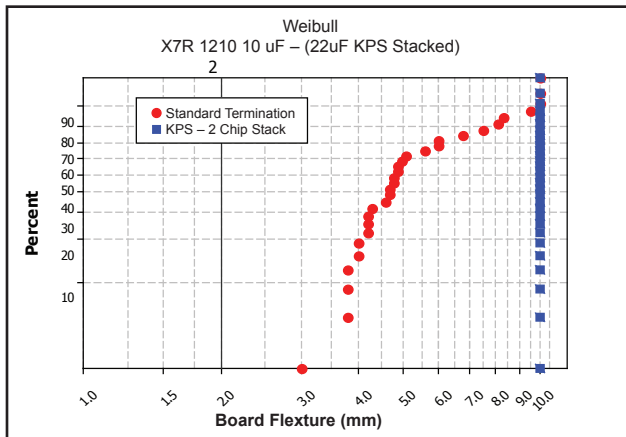

Board Flex vs. Termination Type

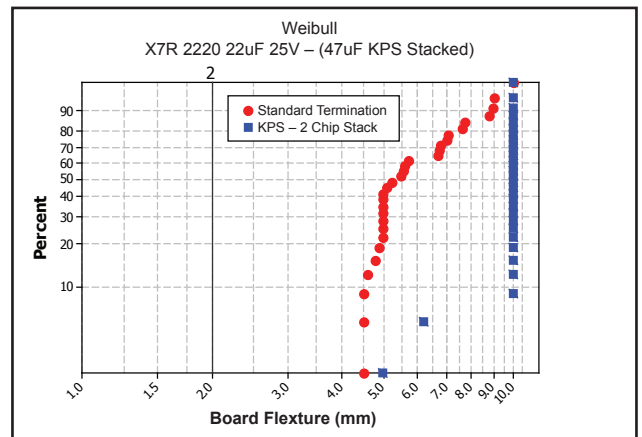

Board Flexure to 10mm

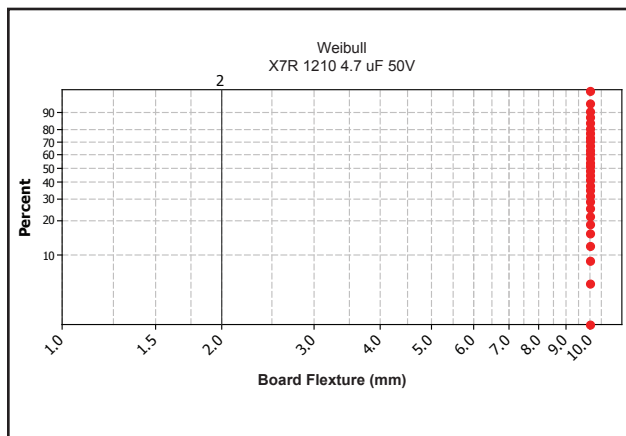

Board Flexure to 10mm

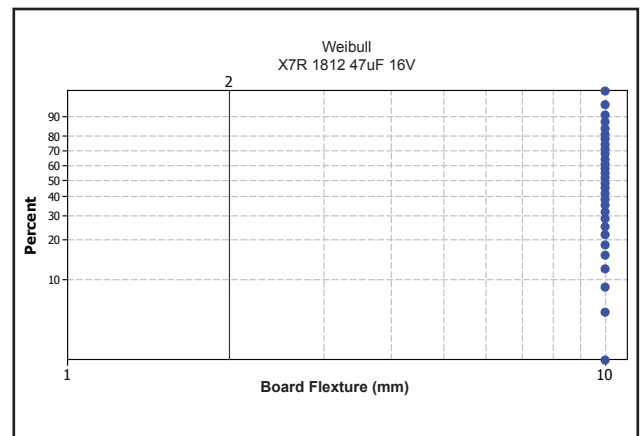

Table 1 – (1210 - 2220 Case Sizes)

Cap pF	Cap Code	Series		C1210						C1812					C2220				
		Voltage Code		8	4	3	5	1	A	4	3	5	1	A	4	3	5	1	A
		Voltage		10	16	25	50	100	250	16	25	50	100	250	16	25	50	100	250
		Cap Tolerance		Product Availability and Chip Thickness Codes - See Table 2 for Chip Thickness Dimensions															
Single Chip Stack																			
0.10 uF	104	K	M	FV	FV	FV	FV	FV	FV	GP	GP	GP	GP	GP	JS	JS	JS	JS	JS
0.22 uF	224	K	M	FV	FV	FV	FV	FV	FV	GP	GP	GP	GP	GP	JS	JS	JS	JS	JS
0.47 uF	474	K	M	FV	FV	FV	FV	FV	FV	GP	GP	GP	GP	GP	JS	JS	JS	JS	JS
1.0 uF	105	K	M	FV	FV	FV	FV	FV	FV	GP	GP	GP	GP	GP	JS	JS	JS	JS	JS
2.2 uF	225	K	M	FV	FV	FV	FV	FV	FV	GP	GP	GP	GP	GP	JS	JS	JS	JS	JS
3.3 uF	335	K	M	FV	FV	FV	FV	FV	FV	GP	GP	GP	GP	GP	JS	JS	JS	JS	JS
4.7 uF	475	K	M	FV	FV	FV	FV	FV	FV	GP	GP	GP	GP	GP	JS	JS	JS	JS	JS
10 uF	106	K	M	FV	FV	FV	FV	FV	FV	GP	GP	GP	GP	GP	JS	JS	JS	JS	JS
15 uF	156	K	M	FV	FV	FV	FV	FV	FV	GP	GP	GP	GP	GP	JS	JS	JS	JS	JS
22 uF	226	K	M	FV	FV	FV	FV	FV	FV	GP	GP	GP	GP	GP	JS	JS	JS	JS	JS
33 uF	336	K	M																
47 uF	476	K	M																
100 uF	107	K	M																
Double Chip Stack																			
0.10 uF	104		M	FW	FW	FW	FW	FW	FW	GR	GR	GR	GR	GR	JR	JR	JR	JR	JR
0.22 uF	224		M	FW	FW	FW	FW	FW	FW	GR	GR	GR	GR	GR	JR	JR	JR	JR	JR
0.47 uF	474		M	FW	FW	FW	FW	FW	FW	GR	GR	GR	GR	GR	JR	JR	JR	JR	JR
1.0 uF	105		M	FW	FW	FW	FW	FW	FW	GR	GR	GR	GR	GR	JR	JR	JR	JR	JR
2.2 uF	225		M	FW	FW	FW	FW	FW	FW	GR	GR	GR	GR	GR	JR	JR	JR	JR	JR
3.3 uF	335		M	FW	FW	FW	FW	FW	FW	GR	GR	GR	GR	GR	JR	JR	JR	JR	JR
4.7 uF	475		M	FW	FW	FW	FW	FW	FW	GR	GR	GR	GR	GR	JR	JR	JR	JR	JR
10 uF	106		M	FW	FW	FW	FW	FW	FW	GR	GR	GR	GR	GR	JR	JR	JR	JR	JR
22 uF	226		M	FW	FW	FW	FW	FW	FW	GR	GR	GR	GR	GR	JR	JR	JR	JR	JR
33 uF	336		M	FW	FW	FW	FW	FW	FW	GR	GR	GR	GR	GR	JR	JR	JR	JR	JR
47 uF	476		M	FW	FW	FW	FW	FW	FW	GR	GR	GR	GR	GR	JR	JR	JR	JR	JR
100 uF	107		M																
220 uF	227		M																
Cap pF	Cap Code	Voltage		10	16	25	50	100	250	16	25	50	100	250	16	25	50	100	250
		Voltage Code		8	4	3	5	1	A	4	3	5	1	A	4	3	5	1	A
		Series		C1210						C1812					C2220				

Table 2 – Chip Thickness / Packaging Quantities

Thickness Code	Chip Size	Thickness ± Range (mm)	Qty per Reel 7" Plastic	Qty per Reel 13" Plastic
FV	1210	3.35 ± 0.10	600	2000
FW	1210	6.15 ± 0.15	300	1000
GP	1812	2.65 ± 0.35	500	2000
GR	1812	5.00 ± 0.50	400	1700
JS	2220	3.50 ± 0.30	300	1300
JR	2220	5.00 ± 0.50	200	800

Package Quantity Based on Finished Chip Thickness Specifications

Soldering Process

Recommended Soldering Technique:

- Mounting technique is limited to solder reflow only.

Recommended Soldering Profile

- KEMET recommends following the guidelines outlined in IPC/JEDEC J-STD-020D.1

Table 3 – Chip Capacitor Land Pattern Design Recommendations per IPC-7351

EIA Size Code	Metric Size Code	Median (Nominal) Land Protrusion (mm)		
		X	Y	C
1210	3225	1.75	1.14	3.00
1812	4532	2.87	1.35	4.39
2220	5650	4.78	2.08	5.38

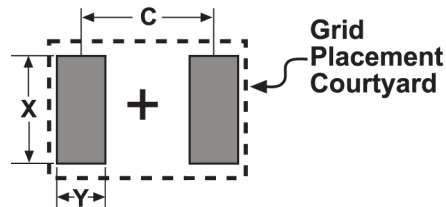

Table 4 – Performance & Reliability: Test Methods and Conditions

Stress	Reference	Test or Inspection Method
Ripple Current	Heat Generation ΔT : 20°C max.	Reflow solder the capacitor onto a PC board and apply voltage with 10kHz~1Mhz sine curve. (Ripple voltage must be < rated voltage)
Terminal Strength	JIS-C-6429	Appendix 1, Note:Force of 1.8kg for 60 seconds.
Board Flex	JIS-C-6429	Appendix 2, Note:2mm (min) for all except 3mm for C0G.
Solderability	J-STD-002	Magnification 50X. Conditions: a) Method B, 4 hrs @ 155°C, dry heat @ 235°C b) Method B @ 215°C category 3 c) Method D, category 3 @ 260°C
Temperature Cycling	JESD22 Method JA-104	1000 Cycles (-55°C to +125°C), Measurement at 24 hrs. +/- 2 hrs after test conclusion.
Biased Humidity	MIL-STD-202 Method 103	Load Humidity: 1000 hours 85°C/85%RH and Rated Voltage.Add 100K ohm resistor. Measurement at 24 hrs. +/- 2 hrs after test conclusion. Low Volt Humidity:1000 hours 85°C/85%RH and 1.5V.Add 100K ohm resistor. Measurement at 24 hrs. +/- 2 hrs after test conclusion.
Moisture Resistance	MIL-STD-202 Method 106	t = 24 hours/cycle.Steps 7a & 7b not required.Unpowered. Measurement at 24 hrs. +/- 2 hrs after test conclusion.
Thermal Shock	MIL-STD-202 Method 107	-55°C/+125°C.Note: Number of cycles required-300, Maximum transfer time-20 seconds, Dwell time-15 minutes.Air-Air.
High Temperature Life	MIL-STD-202 Method 108	1000 hours at 125°C (85°C for X5R, Z5U and Y5V) with 1.5X rated voltage applied.
Storage Life	MIL-STD-202 Method 108	150°C, 0VDC, for 1000 Hours.
Mechanical Shock	MIL-STD-202 Method 213	Figure 1 of Method 213, Condition F.
Resistance to Solvents	MIL-STD-202 Method 215	Add Aqueous wash chemical - OKEM Clean or equivalent.

Tape & Reel Packaging Information

KEMET offers Multilayer Ceramic Chip Capacitors packaged in 8mm, 12mm and 16mm tape on 7" and 13" reels in accordance with EIA standard 481. This packaging system is compatible with all tape fed automatic pick and place systems. See Table 2 for details on reeling quantities for commercial chips.

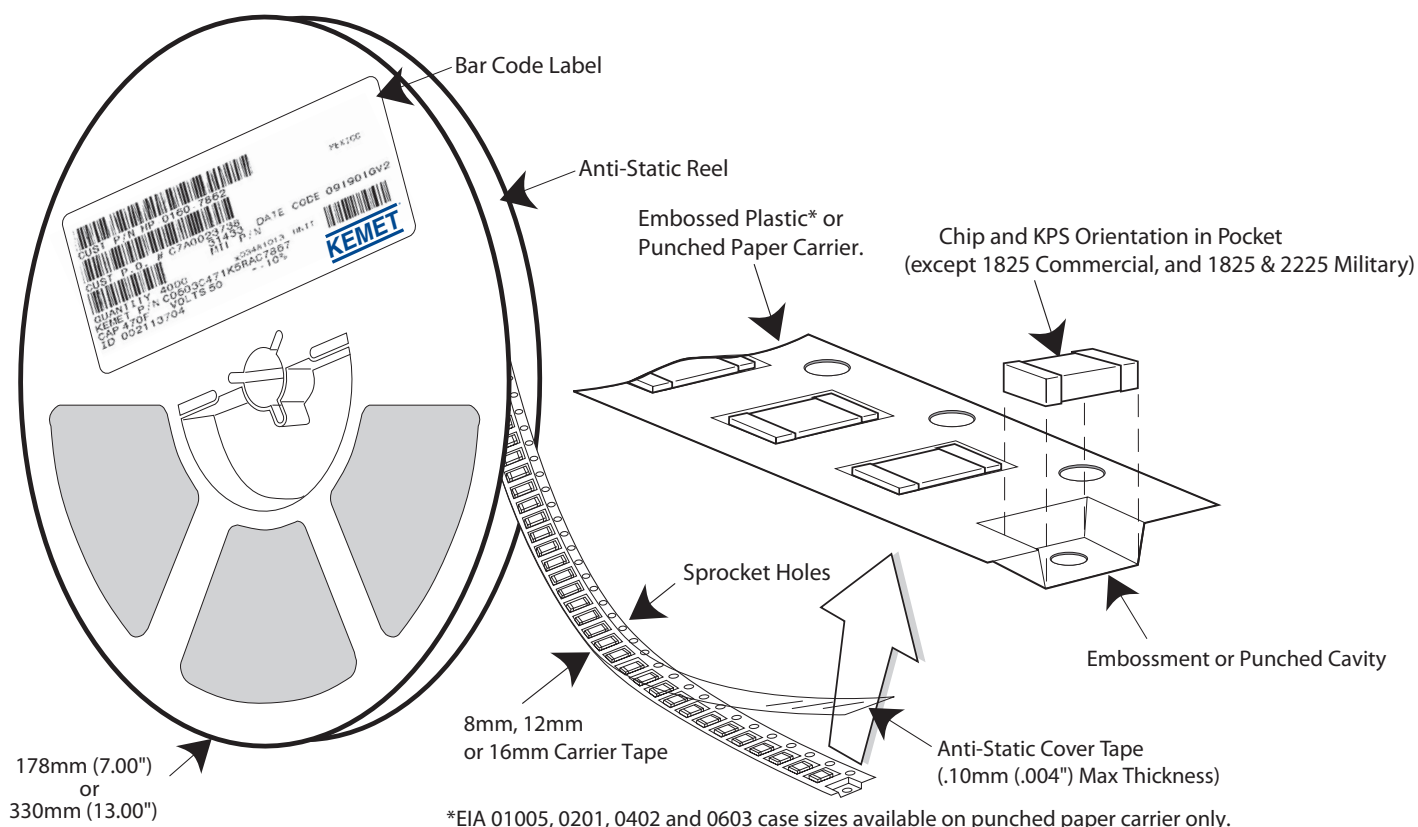

Table 5 - Carrier Tape Configuration (mm)

EIA Case Size	Tape size (W)*	Pitch (P ₁)*
01005 - 0402	8	2
0603 - 1210	8	4
1805 - 1808	12	4
≥ 1812	12	8
KPS 1210	12	8
KPS 1812 & 2220	16	12
Array 0508 & 0612	8	4

*Refer to Figure 1 for W and P₁ carrier tape reference locations.

*Refer to Table 4 for tolerance specifications.

Figure 1: Embossed (Plastic) Carrier Tape Dimensions

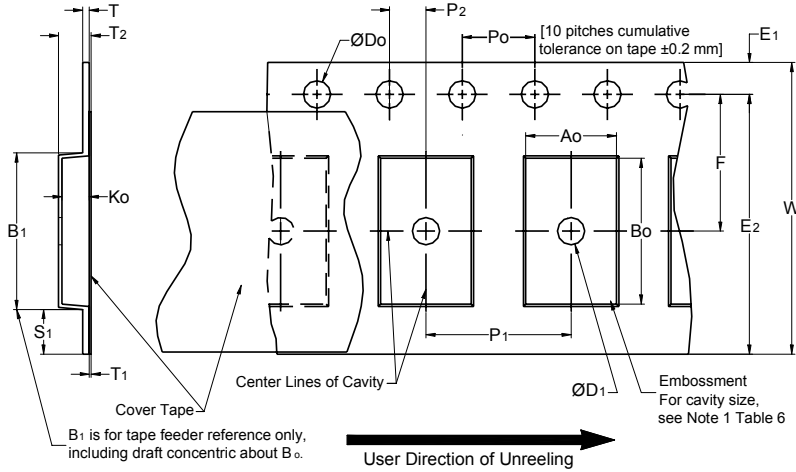

Table 6 - Embossed (Plastic) Carrier Tape Dimensions

(Metric will govern)

Constant Dimensions — Millimeters (Inches)									
Tape Size	D ₀	D ₁ Min. Note 1	E ₁	P ₀	P ₂	R Ref. Note 2	S ₁ Min. Note 3	T Max.	T ₁ Max.
8mm	1.5 +0.10/-0.0 (0.059 +0.004/-0.0)	1.0 (0.039)	1.75 ± 0.10 (0.069 ± 0.004)	4.0 ± 0.10 (0.157 ± 0.004)	2.0 ± 0.05 (0.079 ± 0.002)	25.0 (0.984)	0.600 (0.024)	0.600 (0.024)	0.100 (0.004)
12mm		1.5 (0.059)							
16mm									
Variable Dimensions — Millimeters (Inches)									
Tape Size	Pitch	B ₁ Max. Note 4	E ₂ Min.	F	P ₁	T ₂ Max	W Max	A ₀ , B ₀ & K ₀	
8mm	Single (4mm)	4.35 (0.171)	6.25 (0.246)	3.5 ± 0.05 (0.138 ± 0.002)	4.0 ± 0.10 (0.157 ± 0.004)	2.5 (0.098)	8.3 (0.327)	Note 5	
12mm	Single (4mm) & Double (8mm)	8.2 (0.323)	10.25 (0.404)	5.5 ± 0.05 (0.217 ± 0.002)	8.0 ± 0.10 (0.315 ± 0.004)	4.6 (0.181)	12.3 (0.484)		
16mm	Triple (12mm)	12.1 (0.476)	14.25 (0.561)	5.5 ± 0.05 (0.217 ± 0.002)	8.0 ± 0.10 (0.315 ± 0.004)	4.6 (0.181)	16.3 (0.642)		

- The embossment hole location shall be measured from the sprocket hole controlling the location of the embossment. Dimensions of embossment location and hole location shall be applied independent of each other.
- The tape with or without components shall pass around R without damage (see Figure 5).
- If $S_1 < 1.0$ mm, there may not be enough area for cover tape to be properly applied (see EIA Document 481 paragraph 4.3 (b)).
- B₁ dimension is a reference dimension for tape feeder clearance only.
- The cavity defined by A₀, B₀ and K₀ shall surround the component with sufficient clearance that:
 - the component does not protrude above the top surface of the carrier tape.
 - the component can be removed from the cavity in a vertical direction without mechanical restriction, after the top cover tape has been removed.
 - rotation of the component is limited to 20° maximum for 8 and 12mm tapes and 10° maximum for 16mm tapes (see Figure 3).
 - lateral movement of the component is restricted to 0.5 mm maximum for 8mm and 12mm wide tape and to 1.0mm maximum for 16mm tape (see Figure 4)
 - For KPS Series product A₀ and B₀ are measured on a plane 0.3mm above the bottom of the pocket.
 - see Addendum in EIA Document 481 for standards relating to more precise taping requirements.

Figure 2 – Punched (Paper) Carrier Tape Dimensions

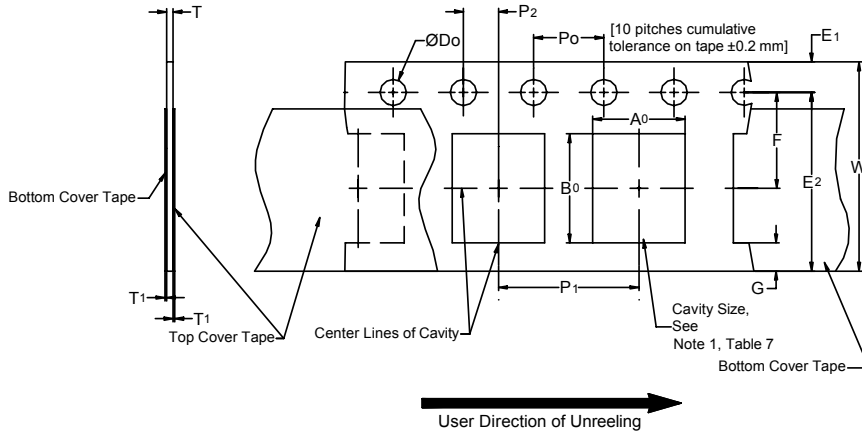

Table 7 - Punched (Paper) Carrier Tape Dimensions
 (Metric will govern)

Constant Dimensions — Millimeters (Inches)							
Tape Size	D ₀	E ₁	P ₀	P ₂	T ₁ Max	G Min	R Ref. Note 2
8mm	1.5 +0.10-0.0 (0.059 +0.004, -0.0)	1.75 ±0.10 (0.069 ±0.004)	4.0 ±0.10 (0.157 ±0.004)	2.0 ±0.05 (0.079 ±0.002)	0.10 (.004) Max.	0.75 (.030)	25 (.984)
Variable Dimensions — Millimeters (Inches)							
Tape Size	Pitch	E2 Min	F	P ₁	T Max	W Max	A ₀ B ₀
8mm	Half (2mm)	6.25 (0.246)	3.5 ± 0.05 (0.138 ± 0.002)	2.0 ± 0.05 (0.079 ± 0.002)	1.1 (0.098)	8.3 (0.327)	Note 5
8mm	Single (4mm)			4.0 ± 0.10 (0.157 ± 0.004)			

- The cavity defined by A₀, B₀ and T shall surround the component with sufficient clearance that:
 - the component does not protrude beyond either surface of the carrier tape.
 - the component can be removed from the cavity in a vertical direction without mechanical restriction, after the top cover tape has been removed.
 - lateral movement of the component is restricted to 0.5 mm maximum (see Figure 4).
 - see Addendum in EIA Document 481 for standards relating to more precise taping requirements.
- The tape with or without components shall pass around R without damage (see Figure 5).

Packaging Information Performance Notes

1. **Cover Tape Break Force:** 1.0 Kg Minimum.
2. **Cover Tape Peel Strength:** The total peel strength of the cover tape from the carrier tape shall be:

Tape Width	Peel Strength
8mm	0.1 Newton to 1.0 Newton (10g to 100g)
12mm & 16mm	0.1 Newton to 1.3 Newton (10g to 130g)

The direction of the pull shall be opposite the direction of the carrier tape travel. The pull angle of the carrier tape shall be 165° to 180° from the plane of the carrier tape. During peeling, the carrier and/or cover tape shall be pulled at a velocity of 300±10 mm/minute.

3. **Labeling:** Bar code labeling (standard or custom) shall be on the side of the reel opposite the sprocket holes. Refer to EIA-556 and EIA-624.

Figure 3 – Maximum component rotation

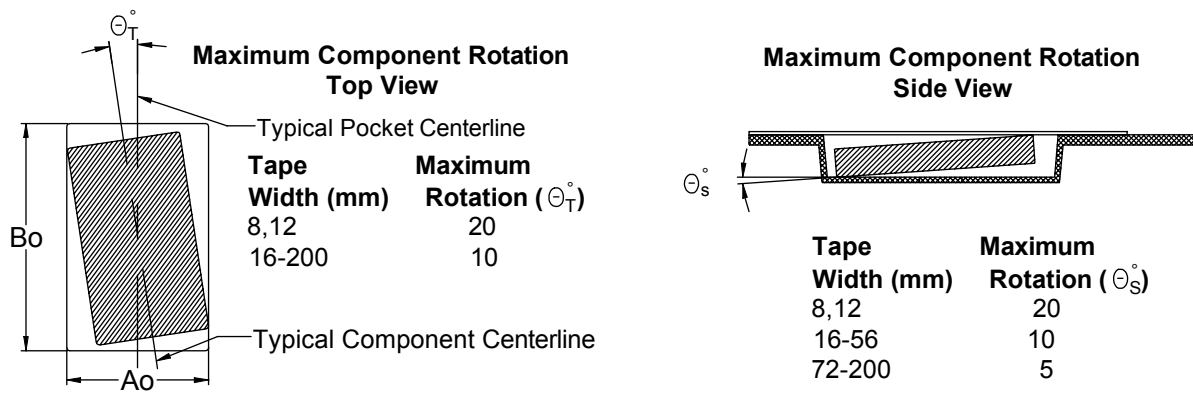

Figure 4 – Maximum lateral movement

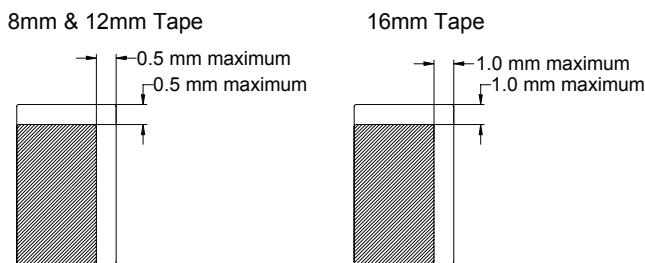

Figure 5 – Bending radius

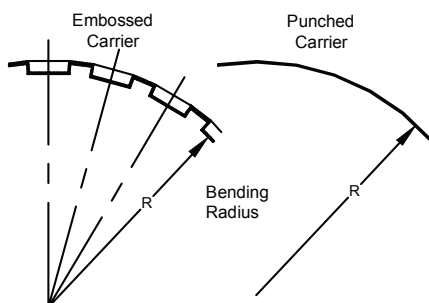

Figure 6 – Reel Dimensions

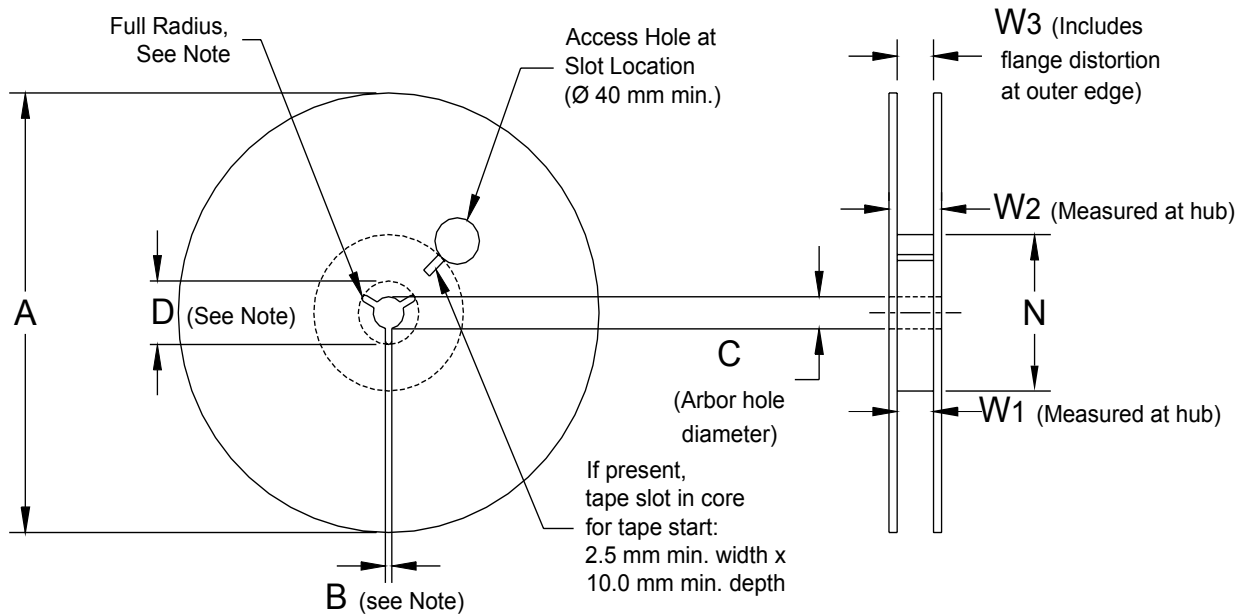

Table 8 – Reel Dimensions

(Metric Dimensions Will Govern)

Constant Dimensions — Millimeters (Inches)				
Tape Size	A	B Min	C	D Min
8mm	178 ± 0.20 (7.008 ± 0.008)	1.5 (0.059)	13.0 +0.5/-0.2 (0.521 +0.02/-0.008)	20.2 (0.795)
12mm	or			
16mm	330 ± 0.20 (13.000 ± 0.008)			
Variable Dimensions — Millimeters (Inches)				
Tape Size	N Min	W ₁	W ₂ Max	W ₃
8mm	50 (1.969)	8.4 +1.5/-0.0 (0.331 +0.059/-0.0)	14.4 (0.567)	Shall Accommodate Tape Width Without Interference
12mm		12.4 +2.0/-0.0 (0.488 +0.078/-0.0)	18.4 (0.724)	
16mm		16.4 +2.0/-0.0 (0.646 +0.078/-0.0)	22.4 (0.882)	

Figure 7 – Tape leader & trailer dimensions

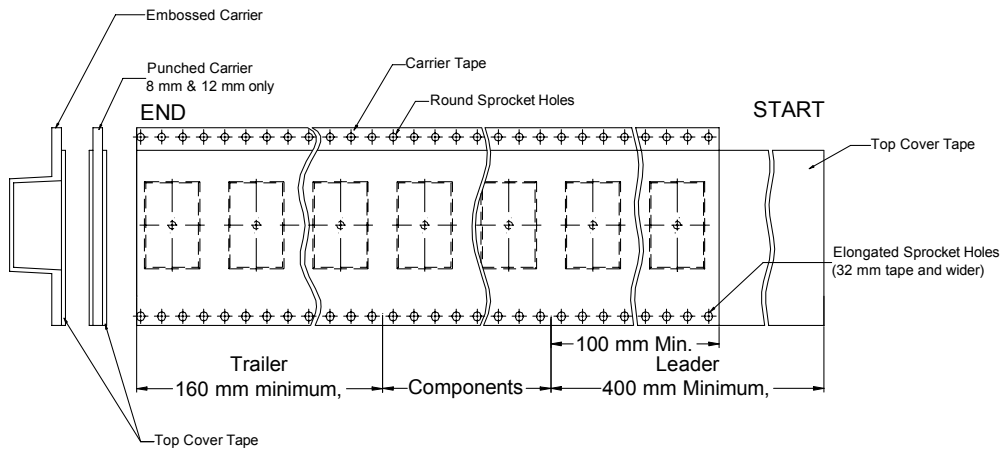
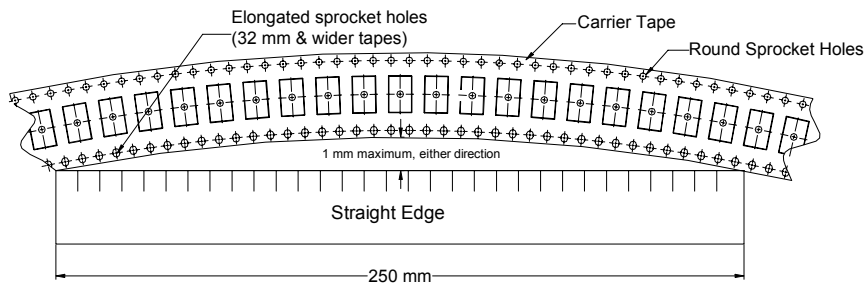

Figure 8 – Maximum camber



Other KEMET Resources

Tools	
Resource	Location
Configure A Part: CapEdge	http://capacitoredge.kemet.com
SPICE & FIT Software	http://www.kemet.com/spice
Search Our FAQs: KnowledgeEdge	http://www.kemet.com/keask

Product Information	
Resource	Location
Products	http://www.kemet.com/products
Technical Resources (Including Soldering Techniques)	http://www.kemet.com/technicalpapers
RoHS Statement	http://www.kemet.com/rohs
Quality Documents	http://www.kemet.com/qualitydocuments

Product Request	
Resource	Location
Sample Request	http://www.kemet.com/sample
Engineering Kit Request	http://www.kemet.com/kits

Contact	
Resource	Location
Website	www.kemet.com
Contact Us	http://www.kemet.com/contact
Investor Relations	http://www.kemet.com/ir
Call Us	1-877-MyKEMET
Twitter	http://twitter.com/kemetcapacitors

KEMET Corporation World Headquarters

P.O. Box 5928
 Greenville, SC 29606
 www.kemet.com
 Tel: 864-963-6300
 Fax: 864-963-6521

North America Corporate Offices

101 NE Third Avenue
 Tower 101, Suite 1700
 Fort Lauderdale, FL 33301
 Tel: 954-766-2800
 Fax: 954-766-2805

Southeast

801 International Parkway, Suite 500
 Lake Mary, FL 32746
 Tel: 407-855-8886

Northeast

340-X Fordham Road
 Wilmington, MA 01887
 Phone: 978-658-1663
 Fax: 978-658-1790

Central

1900 North Roselle Road, Suite 405
 Schaumburg, IL 60195
 Tel: 847-882-3590
 Fax: 847-882-3046

West

1551 McCarthy Boulevard, Suite 117
 Milpitas, CA 95035
 Tel: 408-433-9946
 Fax: 408-433-9946

Mexico

Tezozomoc No. 47
 Col. Ciudad del Sol
 Zapopan, Jalisco C.P. 45050
 Mexico
 Tel: 52-33-3123-2141
 Fax: 52-33-3123-2144

Europe

Southern Europe

15bis chemin des Mines
 1202 Geneva
 Switzerland
 Tel: 41-22-715-0100
 Fax: 41-22-715-0170

Zac Paris Rive Gauche
 118-122 avenue de France
 75013 Paris, France
 Tel: 33-1-4646-1009
 Fax: 33-1-4646-1599

Via San Lorenzo 19
 Sasso Marconi, BO
 40037 Italy
 Tel: 39-051-939111
 Fax: 39-051-840684

Via Milanofiori Palazzo
 A/2 Scala 2
 Milano 20090 Italy
 Tel: 39-02-57518176
 Fax: 39-02-57512093

Central Europe

Hermann-Koehl-Str. 2
 Landsberg am Lech
 86899 Germany
 Tel: 49-8191-3350800
 Fax: 49-8191-3350990

Ruhrallee 9
 Dortmund
 44139 Germany
 Tel: 49-2307-3619672
 Fax: 49-2307-961527

Northern Europe

Unit 1, Ducketts Wharf
 South Street
 Bishops Stortford
 Hertfordshire CM23 3AL
 United Kingdom
 Phone: 44-1279-757201
 Fax: 44-1279-465237

20 Cumberland Drive
 Granby Industrial Estate
 Weymouth, Dorset DT4 9TE
 United Kingdom
 Tel: 44-1305-830747
 Fax: 44-1305-760670

Thörnblads Väg 6
 Färjestaden 386 90
 Sweden
 Tel: 46-485-563934
 Fax: 46-485-563938

Stella Business Park
 Lars Sonckin kaari 16
 Espoo 02600, Finland
 Tel: 358-9-5406-5000
 Fax: 358-9-5406-5010

Asia

Northeast Asia

30 Canton Road, Room 1512
 Silvercord Tower II
 Tsimshatshui, Kowloon, Hong Kong
 Tel: 852-2305-1168
 Fax: 852-2759-0345

Room 1411, 14/F New China Insurance Edifice
 Mintian Road, CBD Futian District
 Shenzhen 518001, China
 Tel: 1-867-55-25181306
 Fax: 1-867-55-25181307

Floor 17, Tower B, Ping An IFC
 No.1-3 Xin Yuan South Road
 Chao Yang District
 Beijing 100027, China
 Tel: 86-10-5829-1711
 Fax: 86-10-5829-1963

Room 2602, Grand Gateway Tower 1
 No.1 Hong Qiao Road
 Shanghai 200030, China
 Tel: 86-21-6447-0707
 Fax: 86-21-6447-0070

Room 305, Floor 3, #142
 Sec. 4, Chung Hsiao East Road
 Taipei 106, Taiwan ROC
 Tel: 886-2-27528585
 Fax: 886-2-27213129

Southeast Asia

73 Bukit Timah Road
 #05-01 Rex House
 229832 Singapore
 Tel: 65-6586-1900
 Fax: 65-6586-1901

1-5-20 Krystal Point 2
 Lebuh Bukit Kecil 6
 11900 Bayan Baru
 Penang, Malaysia
 Tel: 6-04-6430200
 Fax: 6-04-6444220

Office No. 605, 6th Floor
 Barton Centre M.G. Road
 Bangalore 560 001 India
 Tel: 91-80-653-76817
 Fax: 91-80-2532-0160

Note: KEMET reserves the right to modify minor details of internal and external construction at any time in the interest of product improvement. KEMET does not assume any responsibility for infringement that might result from the use of KEMET Capacitors in potential circuit designs. KEMET is a registered trademark of KEMET Electronics Corporation.