

KEMET Part Number: CK06BX332K
(C062K332K2X5CA)

LDD Mil X7R C11015, Ceramic, Military/High Reliability, 3300 pF, 10%, 200 VDC, BX, N/A, Lead Spacing = 5.08mm

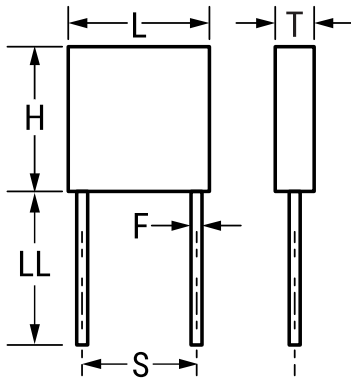

Dimensions	
L	7.37mm +/-0.25mm
H	7.37mm +/-0.25mm
T	2.29mm +/-0.25mm
S	5.08mm +/-0.38mm
LL	31.75mm MIN
F	0.635mm +/-0.051mm

Packaging Specifications	
Packaging:	Bulk, Bag
Packaging Quantity:	100

General Information	
Supplier:	KEMET
Series:	LDD Mil X7R C11015
Style:	Radial
RoHS:	No
Prop 65:	⚠ WARNING: Cancer and reproductive harm - www.p65warnings.ca.gov .
REACH:	SVHC (Pb - CAS 7439-92-1)
Termination:	Lead (SnPb)
Failure Rate:	N/A
Testing and Reliability:	MIL-PRF-11015
Qualifications:	MIL-PRF-11015
Notes:	Lead Length Shown Is For Parts Supplied In Bulk, See Packaging Specifications For Lead Lengths When Not Provided In Bulk

Specifications	
Capacitance:	3300 pF
Capacitance Tolerance:	10%
Voltage DC:	200 VDC
Dielectric Withstanding Voltage:	500 V
Temperature Range:	-55/+125C
Temperature Coefficient:	BX
Dissipation Factor:	2.5%
Insulation Resistance:	100 GOhms

Statements of suitability for certain applications are based on our knowledge of typical operating conditions for such applications, but are not intended to constitute - and we specifically disclaim - any warranty concerning suitability for a specific customer application or use. This Information is intended for use only by customers who have the requisite experience and capability to determine the correct products for their application. Any technical advice inferred from this Information or otherwise provided by us with reference to the use of our products is given gratis, and we assume no obligation or liability for the advice given or results obtained.