

KEMET, GL, EMI/RFI Filters, Noise Suppression, 250 VAC, 250 V, 6 A

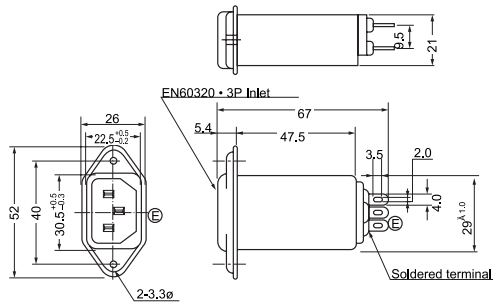

**Dimensions**

<b>L</b>	67mm NOM
<b>W</b>	52mm NOM
<b>H</b>	26mm NOM

**Packaging Specifications**

<b>Packaging:</b>	Tray, Box
<b>Packaging Quantity:</b>	25
<b>Weight:</b>	55 g

**General Information**

<b>Series:</b>	GL
<b>Style:</b>	Metal Box
<b>Description:</b>	Noise Filters
<b>RoHS:</b>	Yes
<b>Qualifications:</b>	UL, CSA, TUV
<b>Miscellaneous:</b>	30 K Self-Temperature Rise Max.

**Specifications**

<b>Voltage AC:</b>	250 VAC
<b>Ripple Current:</b>	6 A (AC/DC)
<b>Rated Temperature:</b>	55°C
<b>Temperature Range:</b>	-25/+55°C
<b>Voltage:</b>	250 VDC, 1500 VAC Withstanding Voltage 1 Min. Line to Ground
<b>Leakage Current:</b>	0.5 mA MAX (250 V 60 Hz)
<b>Resistance:</b>	300 MOhms MIN Insulation 500 VDC 1 Min. Line To Ground