

KEMET, GL, EMI/RFI Filters, Noise Suppression, 250 VAC, 250 V, 15 A

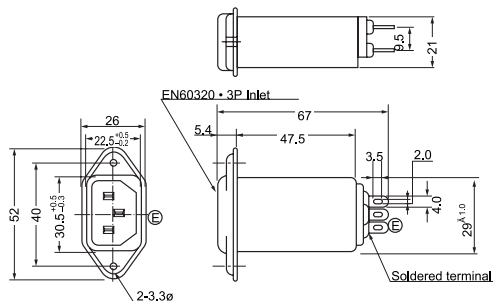

Dimensions	
L	67mm NOM
W	52mm NOM
H	26mm NOM

Packaging Specifications	
Packaging:	Tray, Box
Packaging Quantity:	25
Weight:	55 g

General Information	
Series:	GL
Style:	Metal Box
Description:	Noise Filters
RoHS:	Yes
Qualifications:	UL, CSA, TUV
Miscellaneous:	30 K Self-Temperature Rise Max.

Specifications	
Voltage AC:	250 VAC
Ripple Current:	15 A (AC/DC)
Rated Temperature:	55°C
Temperature Range:	-25/+55°C
Voltage:	250 VDC, 1500 VAC Withstanding Voltage 1 Min. Line to Ground
Leakage Current:	0.5 mA MAX (250 V 60 Hz)
Resistance:	300 MOhms MIN Insulation 500 VDC 1 Min. Line To Ground