

Film, Metallized Polypropylene, Safety, R41, 2200 pF, 20%, 1,000 V, 300 V, 110C, Lead Spacing = 10mm

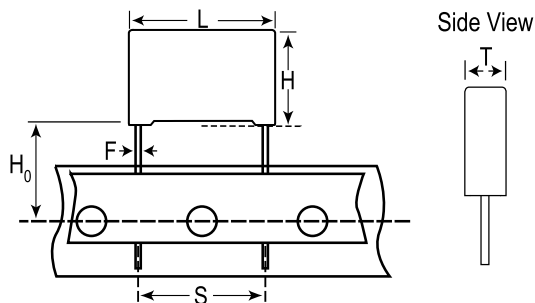

General Information	
<b>Dielectric:</b>	Metallized Polypropylene
<b>Style:</b>	Radial
<b>Series:</b>	R41
<b>Features:</b>	Pulse
<b>RoHS:</b>	Yes
<b>Lead:</b>	Wire Leads
<b>Approvals:</b>	AEC-Q200, ENEC, UL, cUL, CQC
<b>AEC-Q200:</b>	Yes

Dimensions	
<b>L</b>	13mm +0.2mm
<b>H</b>	9mm +0.1mm
<b>T</b>	4mm +0.2mm
<b>S</b>	10mm +/-0.4mm
<b>H0</b>	18.5mm +/-0.5mm
<b>F</b>	0.6mm +/-0.05mm

Specifications	
<b>Capacitance:</b>	2200 pF
<b>Capacitance Tolerance:</b>	20%
<b>Voltage DC:</b>	1000 VDC
<b>Voltage AC:</b>	300 VAC
<b>Temperature Range:</b>	-40/+110C
<b>Rated Temperature:</b>	110C
<b>Dissipation Factor:</b>	0.3% 1kHz
<b>Insulation Resistance:</b>	100 GOhms
<b>Max dVdt:</b>	800 V
<b>Safety Class:</b>	Y2

Packaging Specifications	
<b>Packaging:</b>	Ammo, 360x340x59mm, Box
<b>Packaging Quantity:</b>	1000