

T140, Tantalum, MnO2 Tantalum, Commercial Grade, 68 uF, 10%, 30 VDC, 600 mOhms

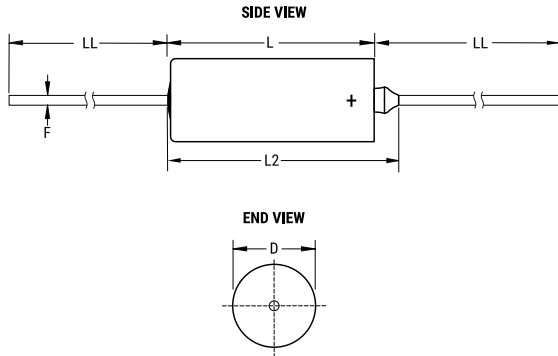

Dimensions	
D	7.34mm +/-0.25mm
L	17.42mm +/-0.79mm
L2	20.88mm
LL	38.1mm +/-6.35mm
F	0.64mm +/-0.05mm

Packaging Specifications	
Packaging:	Bulk, Bag
Packaging Quantity:	20

General Information	
Supplier:	KEMET
Series:	T140
Dielectric:	MnO2 Tantalum
Style:	Axial Hermetic
Description:	Axial, Solid Tantalum, Hermetically Sealed, Military (Non-ER), Polar
Features:	Extended Capacitance, Polar
RoHS:	No
Prop 65:	WARNING: Cancer and reproductive harm - www.p65warnings.ca.gov
REACH:	SVHC (Pb – CAS 7439-92-1)
Termination:	Lead (SnPb)
Lead:	Wire Leads
Construction:	Hermetic
Notes:	Dimensions Include Insulating Sleeve. When Supplied On T&R Or Ammo, Lead Length Is Determined By Taping Specification

Specifications	
Capacitance:	68 uF
Capacitance Tolerance:	10%
Voltage DC:	30 VDC (85C), 26 VDC (125C Surge), 0.3 VDC (125C Reverse)
Temperature Range:	-55/+125C
Rated Temperature:	85C
Resistance:	0.6 Ohms (100kHz)
Leakage Current:	7 uA (25C)

Statements of suitability for certain applications are based on our knowledge of typical operating conditions for such applications, but are not intended to constitute - and we specifically disclaim - any warranty concerning suitability for a specific customer application or use. This Information is intended for use only by customers who have the requisite experience and capability to determine the correct products for their application. Any technical advice inferred from this Information or otherwise provided by us with reference to the use of our products is given gratis, and we assume no obligation or liability for the advice given or results obtained.