

T322, Tantalum, MnO2 Tantalum, Commercial Grade, 6.8 uF, 20%, 15 VDC, 4 Ohms

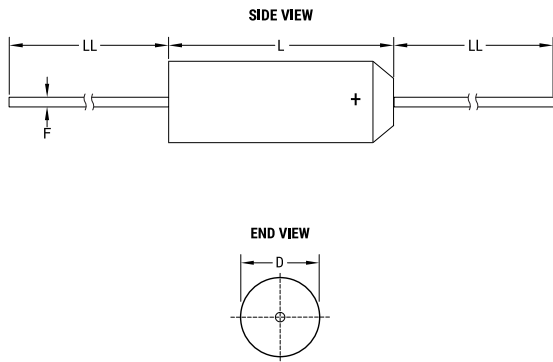

Dimensions	
D	2.79mm MAX
L	7.37mm MAX
LL	38.1mm +/-6.35mm
F	0.51mm +/-0.05mm

Packaging Specifications	
Packaging:	Bulk, Bag
Packaging Quantity:	250

General Information	
Supplier:	KEMET
Series:	T322
Dielectric:	MnO2 Tantalum
Style:	Axial
Description:	Axial, Solid Tantalum, Molded, Military (Non-ER), Low ESR
Features:	Low ESR
RoHS:	Yes
Termination:	Tin
Lead:	Wire Leads
Notes:	Uninsulated
Shelf Life:	156 Weeks

Specifications	
Capacitance:	6.8 uF
Capacitance Tolerance:	20%
Voltage DC:	15 VDC (85C), 10.01 VDC (125C Surge), 0.15 VDC (125C Reverse)
Temperature Range:	-55/+125C
Rated Temperature:	85C
Resistance:	4 Ohms (100kHz)
Leakage Current:	0.8 uA (25C)