

Overview

The KEMET T494 Series is a lower ESR version of the popular T491 Series, designed specifically for today's highly automated surface mount processes and equipment. The T494 combines KEMET's proven solid tantalum technology, acclaimed and respected throughout the world, with the latest in materials, processes and automation, resulting in unsurpassed total performance and value. This product meets or exceeds the requirements of EIA standard 535BAAC. The T494 standard terminations are available in 100% matte tin and provide excellent wetting characteristics and compatibility with today's surface mount solder systems. Tin/lead (Sn/Pb) terminations are available upon request for any part number. Gold-plated terminations are also available for use with conductive epoxy attachment processes.

Standard packaging of these devices is tape and reel in accordance with EIA 481-1. This system provides perfect compatibility with all tape-fed placement units.

Benefits

- Meets or exceeds EIA standard 535BAAC
- Taped and reeled per EIA 481-1
- Symmetrical, compliant terminations
- Optional gold-plated terminations
- Laser-marked case
- 100% surge current test on C, D, E, U, V, X sizes
- Halogen-free epoxy
- Capacitance values of 0.1 μ F to 1000 μ F
- Tolerances of $\pm 10\%$ and $\pm 20\%$
- Voltage rating of 2.5-50 VDC
- Extended range values
- Low profile case sizes
- RoHS compliance and lead-free terminations
- Operating temperature range of -55°C to +125°C

Applications

Typical applications include decoupling and filtering in industrial and automotive end applications, such as DC/DC converters, portable electronics, telecommunications, and control units.



Environmental Compliance

RoHS Compliant (6/6)* according to Directive 2002/95/EC

*When ordered with 100% Sn Solder

SPICE

For a detailed analysis of specific part numbers, please visit kemet.com for a free download of KEMET's SPICE software. The KEMET SPICE program is freeware intended to aid design engineers in analyzing the performance of these capacitors over frequency, temperature, ripple, and DC bias conditions.

Ordering Information

| T | 494 | T | 336 | M | 004 | A | T | |
|-----------------|----------------------|---|--|-----------------------|--|---------------------|---|------------------------------------|
| Capacitor Class | Series | Case Size | Capacitance Code (pF) | Capacitance Tolerance | Voltage | Failure Rate/Design | Lead Material | Packaging (C-Spec) |
| T = Tantalum | Industrial - Low ESR | A = 3216-18 B = 3528-21 C = 6032-28 D = 7343-31 E = 7260-38 R = 2012-12 S = 3216-12 T = 3528-12 U = 6032-15 V = 7343-20 X = 7343-43 | First two digits represent significant figures. Third digit specifies number of zeros. | K = ±10% M = ±20% | 2R5 = 2.5V 003 = 3V 004 = 4V 006 = 6.3V 010 = 10V 016 = 16V 020 = 20V 025 = 25V 035 = 35V 050 = 50V | A = N/A | T = 100% Matte Tin (Sn) Plated H = Standard Solder Coated (SnPb 5% Pb minimum) G = Gold Plated (A, B, C, D, X only) | Blank = 7" Reel 7280 = 13" Reel |

Performance Characteristics

| Item | Performance Characteristics |
|-------------------------|---|
| Operating Temperature | -55°C to 125°C |
| Rated Capacitance Range | 0.1µF–1000µF @ 120 Hz/25°C |
| Capacitance Tolerance | K Tolerance (10%), M Tolerance (20%) |
| Rated Voltage Range | 2.5V–50V |
| DF(120Hz) | Refer to Part Number Electrical Specification Table |
| ESR (100kHz) | Refer to Part Number Electrical Specification Table |
| Leakage Current | ≤ 0.01CV (µA) at Rated Voltage after 5 minutes |

Qualification

| Test | Condition | Characteristics | | | | | |
|----------------------------|--|-----------------|---|-------|------------------------------|----------|--|
| Endurance | 85°C @ Rated Voltage, 2000 Hours 125°C @ 2/3 Rated Voltage, 2000 Hours | ΔC/C | Within ± 10% of initial value | | | | |
| | | DF | Within initial limits | | | | |
| | | DCL | Within 1.25 x initial limit | | | | |
| | | ESR | Within initial limits | | | | |
| Storage Life | 125°C @ 0 Volts, 2000 Hours | ΔC/C | Within ± 10% of initial value | | | | |
| | | DF | Within initial limits | | | | |
| | | DCL | Within 1.25 x initial limit | | | | |
| | | ESR | Within initial limits | | | | |
| Thermal Shock | MIL-STD-202, Method 107, Condition B, mounted, -55°C to 125° C, 1000 cycles | ΔC/C | Within ± 5% of initial value | | | | |
| | | DF | Within initial limits | | | | |
| | | DCL | Within 1.25 x initial limit | | | | |
| | | ESR | Within initial limits | | | | |
| Temperature Stability | Extreme temperature exposure at a succession of continuous steps at +25°C, -55°C, +25°C, +85°C, +125°C, +25°C. | +25°C | -55°C | +85°C | +125°C | | |
| | | ΔC/C | IL* | ±10% | ±10% | ±20% | |
| | | DF | IL | IL | 1.5 x IL | 1.5 x IL | |
| | | DCL | IL | n/a | 10 x IL | 12 x IL | |
| | | Surge Voltage | 25°C and 85°C, 1.32 x Rated Voltage 1000 cycles (125°C, 1.2 x Rated Voltage). | ΔC/C | Within ± 5% of initial value | | |
| | | | | DF | Within initial limits | | |
| DCL | Within initial limits | | | | | | |
| ESR | Within initial limits | | | | | | |
| Mechanical Shock/Vibration | MIL-STD-202, Meth. 213, Cond. I, 100G Peak. MIL-STD-202, Meth. 204, Cond. D, 10Hz to 2000Hz, 20G Peak | ΔC/C | Within ±10% of initial value | | | | |
| | | DF | Within initial limits | | | | |
| | | DCL | Within initial limits | | | | |

*IL = Initial limit

Certification

KEMET's Internal Qualification Plan for this Tantalum series of capacitors follows AEC-Q200 guidelines. Standard catalog part types ordered without a specific automotive designator, i.e., suffix AUTO or four digit customer specific designator (C SPEC), are not considered KEMET Automotive Grade Tantalum capacitors.

Electrical Characteristics

ESR vs. Frequency

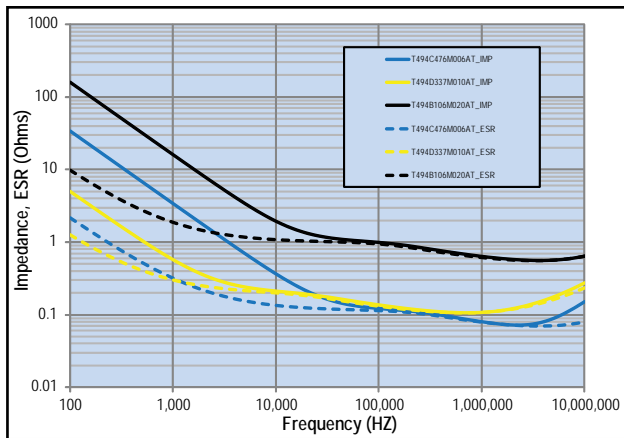

Capacitance vs. Frequency

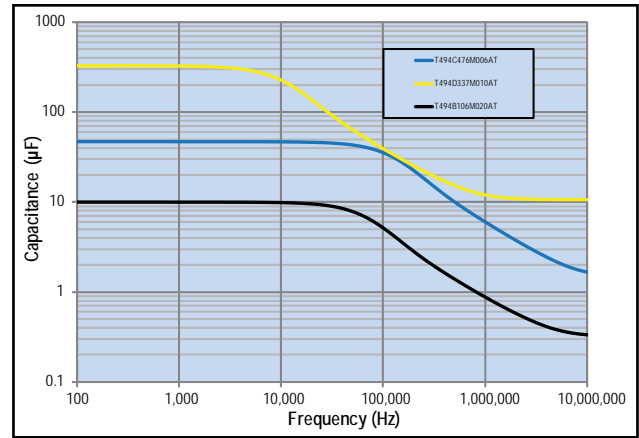

Dimensions – Millimeters (Inches)

Metric will govern

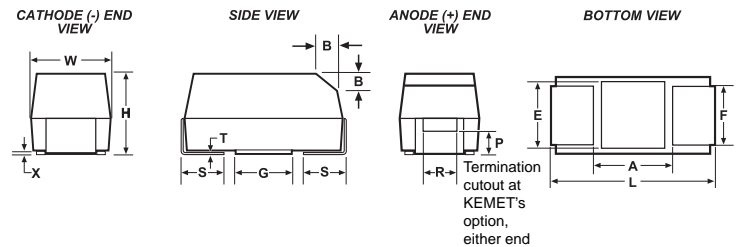

| Case Size | | Component | | | | | | | | | | | | |
|-----------|---------|----------------------------|----------------------------|----------------------------|--------------------|--------------------|-------------------------|------------------------------|------------|------------|-------------|-------------|------------|------------|
| KEMET | EIA | L* | W* | H* | F* ±0.1 ±(.004) | S* ±0.3 ±(.012) | B* ±0.15 (Ref) ±.006 | X (Ref) | P (Ref) | R (Ref) | T (Ref) | A (Min) | G (Ref) | E (Ref) |
| A | 3216-18 | 3.2 ± 0.2 (.126 ± .008) | 1.6 ± 0.2 (.063 ± .008) | 1.6 ± 0.2 (.063 ± .008) | 1.2 (.047) | 0.8 (.031) | 0.4 (.016) | 0.10 ± 0.10 (.004 ± .004) | 0.4 (.016) | 0.4 (.016) | 0.13 (.005) | 1.4 (.055) | 1.1 (.043) | 1.3 (.051) |
| B | 3528-21 | 3.5 ± 0.2 (.138 ± .008) | 2.8 ± 0.2 (.110 ± .008) | 1.9 ± 0.2 (.075 ± .008) | 2.2 (.087) | 0.8 (.031) | 0.4 (.016) | 0.10 ± 0.10 (.004 ± .004) | 0.5 (.020) | 1.0 (.039) | 0.13 (.005) | 2.1 (.083) | 1.8 (.071) | 2.2 (.087) |
| C | 6032-28 | 6.0 ± 0.3 (.236 ± .03) | 3.2 ± 0.3 (.126 ± .012) | 2.5 ± 0.3 (.098 ± .012) | 2.2 (.087) | 1.3 (.051) | 0.5 (.020) | 0.10 ± 0.10 (.004 ± .004) | 0.9 (.035) | 1.0 (.039) | 0.13 (.005) | 3.1 (.122) | 2.8 (.110) | 2.4 (.094) |
| D | 7343-31 | 7.3 ± 0.3 (.287 ± .012) | 4.3 ± 0.3 (.169 ± .012) | 2.8 ± 0.3 (.110 ± .012) | 2.4 (.094) | 1.3 (.051) | 0.5 (.020) | 0.10 ± 0.10 (.004 ± .004) | 0.9 (.035) | 1.0 (.039) | 0.13 (.005) | 3.8 (.150) | 3.5 (.138) | 3.5 (.138) |
| X | 7343-43 | 7.3 ± 0.3 (.287 ± .012) | 4.3 ± 0.3 (.169 ± .012) | 4.0 ± 0.3 (.157 ± .012) | 2.4 (.094) | 1.3 (.051) | 0.5 (.020) | 0.10 ± 0.10 (.004 ± .004) | 1.7 (.067) | 1.0 (.039) | 0.13 (.005) | 3.8 (.150) | 3.5 (.138) | 3.5 (.138) |
| E | 7260-38 | 7.3 ± 0.3 (.287 ± .012) | 6.0 ± 0.3 (.236 ± .012) | 3.6 ± 0.2 (.142 ± .008) | 4.1 (.161) | 1.3 (.051) | 0.5 (.020) | 0.10 ± 0.10 (.004 ± .004) | 0.9 (.035) | 1.0 (.039) | 0.13 (.005) | 0.13 (.005) | 3.5 (.138) | 3.5 (.138) |
| R | 2012-12 | 2.0 ± 0.2 (.079 ± .008) | 1.3 ± 0.2 (.051 ± .008) | 1.2 (.047) | 0.9 (.035) | 0.5 (.020) | N/A | 0.05 (.002) | N/A | N/A | 0.13 (.005) | 0.8 (.031) | 0.5 (.020) | 0.8 (.031) |
| S | 3216-12 | 3.2 ± 0.2 (.126 ± .008) | 1.6 ± 0.2 (.063 ± .008) | 1.2 (.047) | 1.2 (.047) | 0.8 (.031) | N/A | 0.05 (.002) | N/A | N/A | 0.13 (.005) | 1.4 (.055) | 1.1 (.043) | 1.3 (.051) |
| T | 3528-12 | 3.5 ± 0.2 (.138 ± .008) | 2.8 ± 0.2 (.110 ± .008) | 1.2 (.047) | 2.2 (.087) | 0.8 (.031) | N/A | 0.05 (.002) | N/A | N/A | 0.13 (.005) | 2.1 (.083) | 1.8 (.071) | 2.2 (.087) |
| U | 6032-15 | 6.0 ± 0.3 (.236 ± .012) | 3.2 ± 0.2 (.110 ± .008) | 3.2 ± 0.2 | 2.2 (.087) | 1.3 (.051) | N/A | 0.05 (.002) | N/A | N/A | 0.13 (.005) | 3.1 (.122) | 2.8 (.110) | 2.4 (.094) |
| V | 7343-20 | 7.3 ± 0.3 (.287 ± .012) | 4.3 ± 0.3 (.169 ± .012) | 2.0 (.079) | 2.4 (.094) | 1.3 (.051) | N/A | 0.05 (.002) | N/A | N/A | 0.13 (.005) | 3.8 (.150) | 3.5 (.138) | 3.5 (.138) |

Notes: (Ref) – Dimensions provided for reference only. No dimensions provided for B, P or R because low profile cases do not have a bevel or a notch.

* MIL-C-55365/8 specified dimensions

Table 1 – Ratings & Part Number Reference

| Rated Voltage | Rated Cap | Case Code/ Case Size | KEMET Part Number | DC Leakage | DF | ESR | Maximum Allowable Ripple Current | | | Moisture Sensitivity |
|---------------|-------------|-------------------------|------------------------------|-------------------------|----------------------|----------------------|----------------------------------|-----------------------|------------------------|--------------------------|
| | | | | | | | +25°C 100kHz | +85°C 100kHz | +125°C 100kHz | |
| VDC | 120Hz µF | KEMET/EIA | (See below for part options) | µAmps +20°C max/5min | +20°C 120Hz % Max | +20°C 100kHz Ohms | +25°C 100kHz mAmps | +85°C 100kHz mAmps | +125°C 100kHz mAmps | Temp≤260°C J-STD-020D |
| 2.5 | 100 | T/3528-12 | T494T107(1)2R5A(2) | 2.5 | 24.0 | 3.5 | 141 | 127 | 56 | 1 |
| 2.5 | 220 | D/7343-31 | T494D227(1)2R5A(2) | 5.5 | 8.0 | 0.2 | 866 | 779 | 346 | 1 |
| 3 | 33 | A/3216-18 | T494A336(1)003A(2) | 1.0 | 6.0 | 2.0 | 194 | 175 | 78 | 1 |
| 4 | 3.3 | A/3216-18 | T494A335(1)004A(2) | 0.1 | 6.0 | 4.0 | 137 | 123 | 55 | 1 |
| 4 | 4.7 | A/3216-18 | T494A475(1)004A(2) | 0.2 | 6.0 | 3.5 | 146 | 131 | 58 | 1 |
| 4 | 6.8 | A/3216-18 | T494A685(1)004A(2) | 0.3 | 6.0 | 3.0 | 158 | 142 | 63 | 1 |
| 4 | 6.8 | S/3216-12 | T494S685(1)004A(2) | 0.3 | 6.0 | 7.0 | 93 | 84 | 37 | 1 |
| 4 | 10 | B/3528-21 | T494B106(1)004A(2) | 0.4 | 6.0 | 1.2 | 266 | 239 | 106 | 1 |
| 4 | 10 | A/3216-18 | T494A106(1)004A(2) | 0.4 | 6.0 | 2.0 | 194 | 175 | 78 | 1 |
| 4 | 10 | S/3216-12 | T494S106(1)004A(2) | 0.4 | 6.0 | 9.0 | 82 | 74 | 33 | 1 |
| 4 | 10 | R/2012-12 | T494R106(M)004A(2) | 0.4 | 8.0 | 6.0 | 65 | 59 | 26 | 1 |
| 4 | 15 | B/3528-21 | T494B156(1)004A(2) | 0.6 | 6.0 | 1.2 | 266 | 239 | 106 | 1 |
| 4 | 15 | A/3216-18 | T494A156(1)004A(2) | 0.6 | 6.0 | 1.5 | 224 | 202 | 90 | 1 |
| 4 | 15 | T/3528-12 | T494T156(1)004A(2) | 0.6 | 6.0 | 2.0 | 187 | 168 | 75 | 1 |
| 4 | 15 | S/3216-12 | T494S156(M)004A(2) | 0.6 | 10.0 | 9.0 | 82 | 74 | 33 | 1 |
| 4 | 22 | C/6032-28 | T494C226(1)004A(2) | 0.9 | 6.0 | 0.5 | 469 | 422 | 188 | 1 |
| 4 | 22 | B/3528-21 | T494B226(1)004A(2) | 0.9 | 6.0 | 0.6 | 376 | 338 | 150 | 1 |
| 4 | 22 | A/3216-18 | T494A226(1)004A(2) | 0.9 | 6.0 | 1.5 | 224 | 202 | 90 | 1 |
| 4 | 22 | S/3216-12 | T494S226(M)004A(2) | 0.9 | 10.0 | 8.0 | 87 | 78 | 35 | 1 |
| 4 | 22 | T/3528-12 | T494T226(1)004A(2) | 0.9 | 6.0 | 2.5 | 167 | 150 | 67 | 1 |
| 4 | 33 | C/6032-28 | T494C336(1)004A(2) | 1.3 | 6.0 | 0.5 | 469 | 422 | 188 | 1 |
| 4 | 33 | U/6032-15 | T494U336(1)004A(2) | 1.3 | 6.0 | 0.6 | 387 | 348 | 155 | 1 |
| 4 | 33 | B/3528-21 | T494B336(1)004A(2) | 1.3 | 6.0 | 0.5 | 412 | 371 | 165 | 1 |
| 4 | 33 | A/3216-18 | T494A336(1)004A(2) | 1.3 | 6.0 | 3.0 | 158 | 142 | 63 | 1 |
| 4 | 33 | T/3528-12 | T494T336(M)004A(2) | 1.3 | 8.0 | 3.5 | 141 | 127 | 56 | 1 |
| 4 | 47 | C/6032-28 | T494C476(1)004A(2) | 1.9 | 6.0 | 0.5 | 469 | 422 | 188 | 1 |
| 4 | 47 | U/6032-15 | T494U476(1)004A(2) | 1.9 | 6.0 | 0.6 | 387 | 348 | 155 | 1 |
| 4 | 47 | B/3528-21 | T494B476(1)004A(2) | 1.9 | 6.0 | 0.5 | 412 | 371 | 165 | 1 |
| 4 | 47 | A/3216-18 | T494A476(M)004A(2) | 1.9 | 12.0 | 2.0 | 194 | 175 | 78 | 1 |
| 4 | 47 | T/3528-12 | T494T476(M)004A(2) | 1.9 | 12.0 | 4.0 | 132 | 119 | 53 | 1 |
| 4 | 68 | D/7343-31 | T494D686(1)004A(2) | 2.7 | 6.0 | 0.20 | 866 | 779 | 346 | 1 |
| 4 | 68 | C/6032-28 | T494C686(1)004A(2) | 2.7 | 6.0 | 0.25 | 663 | 597 | 265 | 1 |
| 4 | 68 | U/6032-15 | T494U686(1)004A(2) | 2.7 | 6.0 | 0.60 | 387 | 348 | 155 | 1 |
| 4 | 68 | B/3528-21 | T494B686(1)004A(2) | 2.7 | 6.0 | 2.00 | 206 | 185 | 82 | 1 |
| 4 | 68 | A/3216-18 | T494A686(1)004A(2) | 2.7 | 30.0 | 3.00 | 158 | 142 | 63 | 1 |
| 4 | 100 | D/7343-31 | T494D107(1)004A(2) | 4.0 | 8.0 | 0.20 | 866 | 779 | 346 | 1 |
| 4 | 100 | C/6032-28 | T494C107(1)004A(2) | 4.0 | 8.0 | 0.20 | 742 | 668 | 297 | 1 |
| 4 | 100 | U/6032-15 | T494U107(1)004A(2) | 4.0 | 10.0 | 1.00 | 300 | 270 | 120 | 1 |
| 4 | 100 | B/3528-21 | T494B107(M)004A(2) | 4.0 | 8.0 | 0.65 | 362 | 326 | 145 | 1 |
| 4 | 100 | A/3216-18 | T494A107(M)004A(2) | 4.0 | 30.0 | 3.00 | 158 | 142 | 63 | 1 |
| 4 | 100 | T/3528-12 | T494T107(M)004A(2) | 4.0 | 30.0 | 4.50 | 125 | 113 | 50 | 1 |
| 4 | 150 | D/7343-31 | T494D157(1)004A(2) | 6.0 | 8.0 | 0.15 | 1000 | 900 | 400 | 1 |
| 4 | 150 | V/7343-20 | T494V157(1)004A(2) | 6.0 | 8.0 | 0.20 | 791 | 712 | 316 | 1 |
| 4 | 150 | C/6032-28 | T494C157(1)004A(2) | 6.0 | 8.0 | 0.30 | 606 | 545 | 242 | 1 |
| 4 | 150 | B/3528-21 | T494B157(M)004A(2) | 6.0 | 12.0 | 1.00 | 292 | 263 | 117 | 1 |
| 4 | 220 | V/7343-20 | T494V227(1)004A(2) | 8.8 | 8.0 | 0.30 | 645 | 581 | 258 | 1 |
| 4 | 220 | B/3528-21 | T494B227(M)004A(2) | 8.8 | 8.0 | 0.40 | 461 | 415 | 184 | 1 |
| 4 | 330 | D/7343-31 | T494D337(1)004A(2) | 13.2 | 8.0 | 0.15 | 1000 | 900 | 400 | 1 |
| 4 | 330 | C/6032-28 | T494C337(1)004A(2) | 13.2 | 10.0 | 0.09 | 1106 | 995 | 442 | 1 |
| 4 | 330 | V/7343-20 | T494V337(1)004A(2) | 13.2 | 12.0 | 0.30 | 645 | 581 | 258 | 1 |
| VDC | µF | KEMET/EIA | (See below for part options) | max/5min | % Max | Ohms | mAmps | mAmps | mAmps | J-STD-020D |
| Rated Voltage | Rated Cap | Case Code/ Case Size | KEMET Part Number | µAmps +20°C | +20°C 120Hz | +20°C 100kHz | +25°C 100kHz | +85°C 100kHz | +125°C 100kHz | Temp≤260°C |
| Rated Voltage | Rated Cap | Case Code/ Case Size | KEMET Part Number | DC Leakage | DF | ESR | Maximum Allowable Ripple Current | | | Moisture Sensitivity |

(1) To complete KEMET part number, insert M for ± 20% or K for ± 10%. Designates Capacitance tolerance.

(2) To complete KEMET part number, insert T = 100% Matte Tin (Sn) Plated, G = Gold Plated, H = Standard Solder coated (SnPb 5% Pb minimum). Designates Termination Finish.

Refer to Ordering Information for additional detail.

Higher voltage ratings and tighter tolerance product including ESR may be substituted within the same size at KEMET's option. Voltage substitution will be marked with the higher voltage rating. Substitutions can include better than series.

Table 1 – Ratings & Part Number Reference con't

| Rated Voltage | Rated Cap | Case Code/ Case Size | KEMET Part Number | DC Leakage | DF | ESR | Maximum Allowable Ripple Current | | | Moisture Sensitivity |
|---------------|-------------|-------------------------|------------------------------|-------------------------|----------------------|----------------------|----------------------------------|-----------------------|------------------------|--------------------------|
| | | | | | | | +25°C 100kHz | +85°C 100kHz | +125°C 100kHz | |
| VDC | 120Hz µF | KEMET/EIA | (See below for part options) | µAmps +20°C max/5min | +20°C 120Hz % Max | +20°C 100kHz Ohms | +25°C 100kHz mAmps | +85°C 100kHz mAmps | +125°C 100kHz mAmps | Temp≤260°C J-STD-020D |
| 4 | 470 | X/7343-43 | T494X477(1)004A(2) | 18.8 | 8.0 | 0.15 | 1049 | 944 | 420 | 1 |
| 4 | 470 | D/7343-31 | T494D477(1)004A(2) | 18.8 | 8.0 | 0.15 | 1000 | 900 | 400 | 1 |
| 4 | 680 | X/7343-43 | T494X687(M)004A(2) | 27.2 | 12.0 | 0.10 | 1285 | 1157 | 514 | 1 |
| 4 | 680 | D/7343-31 | T494D687(M)004A(2) | 27.2 | 12.0 | 0.15 | 1000 | 900 | 400 | 1 |
| 4 | 1000 | X/7343-43 | T494X108(1)004A(2) | 40.0 | 12.0 | 0.10 | 1285 | 1157 | 514 | 1 |
| 4 | 1000 | E/7260-38 | T494E108(M)004A(2) | 40.0 | 15.0 | 0.08 | 1581 | 1423 | 632 | 1 |
| 6.3 | 2.2 | R/2012-12 | T494R225(1)006A(2) | 0.1 | 6.0 | 20.0 | 35 | 32 | 14 | 1 |
| 6.3 | 2.2 | A/3216-18 | T494A225(1)006A(2) | 0.1 | 6.0 | 6.0 | 112 | 101 | 45 | 1 |
| 6.3 | 3.3 | A/3216-18 | T494A335(1)006A(2) | 0.2 | 6.0 | 6.0 | 112 | 101 | 45 | 1 |
| 6.3 | 4.7 | A/3216-18 | T494A475(1)006A(2) | 0.3 | 6.0 | 3.5 | 146 | 131 | 58 | 1 |
| 6.3 | 4.7 | S/3216-12 | T494S475(1)006A(2) | 0.3 | 6.0 | 8.0 | 87 | 78 | 35 | 1 |
| 6.3 | 6.8 | B/3528-21 | T494B685(1)006A(2) | 0.4 | 6.0 | 1.2 | 266 | 239 | 106 | 1 |
| 6.3 | 6.8 | A/3216-18 | T494A685(1)006A(2) | 0.4 | 6.0 | 2.0 | 194 | 175 | 78 | 1 |
| 6.3 | 6.8 | S/3216-12 | T494S685(1)006A(2) | 0.4 | 6.0 | 9.0 | 82 | 74 | 33 | 1 |
| 6.3 | 6.8 | R/2012-12 | T494R685(1)006A(2) | 0.4 | 8.0 | 10.0 | 50 | 45 | 20 | 1 |
| 6.3 | 10 | B/3528-21 | T494B106(1)006A(2) | 0.6 | 6.0 | 1.0 | 292 | 263 | 117 | 1 |
| 6.3 | 10 | A/3216-18 | T494A106(1)006A(2) | 0.6 | 6.0 | 2.0 | 194 | 175 | 78 | 1 |
| 6.3 | 10 | T/3528-12 | T494T106(1)006A(2) | 0.6 | 6.0 | 1.2 | 242 | 218 | 97 | 1 |
| 6.3 | 10 | S/3216-12 | T494S106(M)006A(2) | 0.6 | 10.0 | 9.0 | 82 | 74 | 33 | 1 |
| 6.3 | 10 | R/2012-12 | T494R106(M)006A(2) | 0.6 | 8.0 | 6.0 | 65 | 59 | 26 | 1 |
| 6.3 | 15 | C/6032-28 | T494C156(1)006A(2) | 0.9 | 6.0 | 0.6 | 428 | 385 | 171 | 1 |
| 6.3 | 15 | B/3528-21 | T494B156(1)006A(2) | 0.9 | 6.0 | 0.7 | 348 | 313 | 139 | 1 |
| 6.3 | 15 | A/3216-18 | T494A156(1)006A(2) | 0.9 | 6.0 | 2.0 | 194 | 175 | 78 | 1 |
| 6.3 | 15 | T/3528-12 | T494T156(1)006A(2) | 0.9 | 6.0 | 2.5 | 167 | 150 | 67 | 1 |
| 6.3 | 15 | S/3216-12 | T494S156(M)006A(2) | 0.9 | 10.0 | 10.0 | 77 | 69 | 31 | 1 |
| 6.3 | 22 | C/6032-28 | T494C226(1)006A(2) | 1.4 | 6.0 | 0.5 | 469 | 422 | 188 | 1 |
| 6.3 | 22 | U/6032-15 | T494U226(1)006A(2) | 1.4 | 6.0 | 0.8 | 335 | 302 | 134 | 1 |
| 6.3 | 22 | B/3528-21 | T494B226(1)006A(2) | 1.4 | 6.0 | 0.6 | 376 | 338 | 150 | 1 |
| 6.3 | 22 | A/3216-18 | T494A226(1)006A(2) | 1.4 | 6.0 | 3.0 | 158 | 142 | 63 | 1 |
| 6.3 | 22 | T/3528-12 | T494T226(M)006A(2) | 1.4 | 8.0 | 3.5 | 141 | 127 | 56 | 1 |
| 6.3 | 33 | C/6032-28 | T494C336(1)006A(2) | 2.1 | 6.0 | 0.3 | 606 | 545 | 242 | 1 |
| 6.3 | 33 | U/6032-15 | T494U336(1)006A(2) | 2.1 | 6.0 | 0.6 | 387 | 348 | 155 | 1 |
| 6.3 | 33 | B/3528-21 | T494B336(1)006A(2) | 2.1 | 6.0 | 0.6 | 376 | 338 | 150 | 1 |
| 6.3 | 33 | A/3216-18 | T494A336(1)006A(2) | 2.1 | 12.0 | 2.0 | 194 | 175 | 78 | 1 |
| 6.3 | 33 | T/3528-12 | T494T336(M)006A(2) | 2.1 | 12.0 | 4.0 | 132 | 119 | 53 | 1 |
| 6.3 | 47 | D/7343-31 | T494D476(1)006A(2) | 3.0 | 6.0 | 0.22 | 826 | 743 | 330 | 1 |
| 6.3 | 47 | C/6032-28 | T494C476(1)006A(2) | 3.0 | 6.0 | 0.25 | 663 | 597 | 265 | 1 |
| 6.3 | 47 | U/6032-15 | T494U476(1)006A(2) | 3.0 | 6.0 | 0.60 | 387 | 348 | 155 | 1 |
| 6.3 | 47 | B/3528-21 | T494B476(1)006A(2) | 3.0 | 6.0 | 0.50 | 412 | 371 | 165 | 1 |
| 6.3 | 47 | A/3216-18 | T494A476(M)006A(2) | 3.0 | 12.0 | 2.50 | 173 | 156 | 69 | 1 |
| 6.3 | 47 | T/3528-12 | T494T476(1)006A(2) | 3.0 | 24.0 | 4.00 | 132 | 119 | 53 | 1 |
| 6.3 | 68 | D/7343-31 | T494D686(1)006A(2) | 4.3 | 6.0 | 0.20 | 866 | 779 | 346 | 1 |
| 6.3 | 68 | C/6032-28 | T494C686(1)006A(2) | 4.3 | 6.0 | 0.20 | 742 | 668 | 297 | 1 |
| 6.3 | 68 | U/6032-15 | T494U686(1)006A(2) | 4.3 | 10.0 | 1.00 | 300 | 270 | 120 | 1 |
| 6.3 | 68 | B/3528-21 | T494B686(M)006A(2) | 4.3 | 8.0 | 0.65 | 362 | 326 | 145 | 1 |
| 6.3 | 68 | A/3216-18 | T494A686(1)006A(2) | 4.3 | 30.0 | 3.00 | 158 | 142 | 63 | 1 |
| 6.3 | 100 | D/7343-31 | T494D107(1)006A(2) | 6.3 | 8.0 | 0.15 | 1000 | 900 | 400 | 1 |
| 6.3 | 100 | V/7343-20 | T494V107(1)006A(2) | 6.3 | 8.0 | 0.20 | 791 | 712 | 316 | 1 |
| 6.3 | 100 | C/6032-28 | T494C107(1)006A(2) | 6.3 | 8.0 | 0.30 | 606 | 545 | 242 | 1 |
| 6.3 | 100 | U/6032-15 | T494U107(M)006A(2) | 6.3 | 10.0 | 1.20 | 274 | 247 | 110 | 1 |
| 6.3 | 100 | B/3528-21 | T494B107(1)006A(2) | 6.3 | 15.0 | 1.50 | 238 | 214 | 95 | 1 |
| VDC | µF | KEMET/EIA | (See below for part options) | max/5min | % Max | Ohms | mAmps | mAmps | mAmps | J-STD-020D |
| Rated Voltage | Rated Cap | Case Code/ Case Size | KEMET Part Number | µAmps +20°C | +20°C 120Hz | +20°C 100kHz | +25°C 100kHz | +85°C 100kHz | +125°C 100kHz | Temp≤260°C |
| Rated Voltage | Rated Cap | Case Code/ Case Size | KEMET Part Number | DC Leakage | DF | ESR | Maximum Allowable Ripple Current | | | Moisture Sensitivity |

(1) To complete KEMET part number, insert M for ± 20% or K for ± 10%. Designates Capacitance tolerance.

(2) To complete KEMET part number, insert T = 100% Matte Tin (Sn) Plated, G = Gold Plated, H = Standard Solder coated (SnPb 5% Pb minimum). Designates Termination Finish.

Refer to Ordering Information for additional detail.

Higher voltage ratings and tighter tolerance product including ESR may be substituted within the same size at KEMET's option. Voltage substitution will be marked with the higher voltage rating. Substitutions can include better than series.

Table 1 – Ratings & Part Number Reference con't

| Rated Voltage | Rated Cap | Case Code/ Case Size | KEMET Part Number | DC Leakage | DF | ESR | Maximum Allowable Ripple Current | | | Moisture Sensitivity |
|---------------|-------------|-------------------------|------------------------------|-------------------------|----------------------|----------------------|----------------------------------|-----------------------|------------------------|--------------------------|
| | | | | | | | +25°C 100kHz | +85°C 100kHz | +125°C 100kHz | |
| VDC | 120Hz µF | KEMET/EIA | (See below for part options) | µAmps +20°C max/5min | +20°C 120Hz % Max | +20°C 100kHz Ohms | +25°C 100kHz mAmps | +85°C 100kHz mAmps | +125°C 100kHz mAmps | Temp≤260°C J-STD-020D |
| 6.3 | 150 | D/7343-31 | T494D157(1)006A(2) | 9.5 | 8.0 | 0.15 | 1000 | 900 | 400 | 1 |
| 6.3 | 150 | C/6032-28 | T494C157(M)006A(2) | 9.5 | 8.0 | 0.30 | 606 | 545 | 242 | 1 |
| 6.3 | 150 | V/7343-20 | T494V157(1)006A(2) | 9.5 | 8.0 | 0.30 | 645 | 581 | 258 | 1 |
| 6.3 | 220 | X/7343-43 | T494X227(1)006A(2) | 13.9 | 8.0 | 0.15 | 1049 | 944 | 420 | 1 |
| 6.3 | 220 | D/7343-31 | T494D227(1)006A(2) | 13.9 | 8.0 | 0.15 | 1000 | 900 | 400 | 1 |
| 6.3 | 220 | C/6032-28 | T494C227(M)006A(2) | 13.9 | 10.0 | 0.30 | 606 | 545 | 242 | 1 |
| 6.3 | 220 | V/7343-20 | T494V227(M)006A(2) | 13.9 | 12.0 | 0.30 | 645 | 581 | 258 | 1 |
| 6.3 | 330 | X/7343-43 | T494X337(1)006A(2) | 20.8 | 8.0 | 0.15 | 1049 | 944 | 420 | 1 |
| 6.3 | 330 | D/7343-31 | T494D337(1)006A(2) | 20.8 | 8.0 | 0.15 | 1000 | 900 | 400 | 1 |
| 6.3 | 330 | E/7260-38 | T494E337(1)006A(2) | 20.8 | 8.0 | 0.25 | 894 | 805 | 358 | 1 |
| 6.3 | 470 | X/7343-43 | T494X477(1)006A(2) | 29.6 | 10.0 | 0.10 | 1285 | 1157 | 514 | 1 |
| 6.3 | 470 | D/7343-31 | T494D477(M)006A(2) | 29.6 | 12.0 | 0.15 | 1000 | 900 | 400 | 1 |
| 6.3 | 470 | E/7260-38 | T494E477(1)006A(2) | 29.6 | 10.0 | 0.20 | 1000 | 900 | 400 | 1 |
| 6.3 | 680 | E/7260-38 | T494E687(M)006A(2) | 42.8 | 12.0 | 0.10 | 1414 | 1273 | 566 | 1 |
| 6.3 | 680 | X/7343-43 | T494X687(1)006A(2) | 42.8 | 12.0 | 0.10 | 1285 | 1157 | 514 | 1 |
| 10 | 1.5 | A/3216-18 | T494A155(1)010A(2) | 0.2 | 6.0 | 6.0 | 112 | 101 | 45 | 1 |
| 10 | 2.2 | B/3528-21 | T494B225(1)010A(2) | 0.2 | 6.0 | 1.5 | 238 | 214 | 95 | 1 |
| 10 | 2.2 | A/3216-18 | T494A225(1)010A(2) | 0.2 | 6.0 | 6.0 | 112 | 101 | 45 | 1 |
| 10 | 3.3 | A/3216-18 | T494A335(1)010A(2) | 0.3 | 6.0 | 4.0 | 137 | 123 | 55 | 1 |
| 10 | 3.3 | S/3216-12 | T494S335(1)010A(2) | 0.3 | 6.0 | 9.0 | 82 | 74 | 33 | 1 |
| 10 | 3.3 | R/2012-12 | T494R335(1)010A(2) | 0.3 | 8.0 | 10.0 | 50 | 45 | 20 | 1 |
| 10 | 4.7 | B/3528-21 | T494B475(1)010A(2) | 0.5 | 6.0 | 1.5 | 238 | 214 | 95 | 1 |
| 10 | 4.7 | A/3216-18 | T494A475(1)010A(2) | 0.5 | 6.0 | 3.0 | 158 | 142 | 63 | 1 |
| 10 | 4.7 | S/3216-12 | T494S475(1)010A(2) | 0.5 | 6.0 | 9.0 | 82 | 74 | 33 | 1 |
| 10 | 4.7 | R/2012-12 | T494R475(M)010A(2) | 0.5 | 8.0 | 8.0 | 56 | 50 | 22 | 1 |
| 10 | 6.8 | B/3528-21 | T494B685(1)010A(2) | 0.7 | 6.0 | 1.2 | 266 | 239 | 106 | 1 |
| 10 | 6.8 | A/3216-18 | T494A685(1)010A(2) | 0.7 | 6.0 | 3.0 | 158 | 142 | 63 | 1 |
| 10 | 6.8 | T/3528-12 | T494T685(1)010A(2) | 0.7 | 6.0 | 2.0 | 187 | 168 | 75 | 1 |
| 10 | 6.8 | S/3216-12 | T494S685(M)010A(2) | 0.7 | 10.0 | 9.0 | 82 | 74 | 33 | 1 |
| 10 | 10 | C/6032-28 | T494C106(1)010A(2) | 1.0 | 6.0 | 0.6 | 428 | 385 | 171 | 1 |
| 10 | 10 | B/3528-21 | T494B106(1)010A(2) | 1.0 | 6.0 | 0.8 | 326 | 293 | 130 | 1 |
| 10 | 10 | A/3216-18 | T494A106(1)010A(2) | 1.0 | 6.0 | 1.8 | 204 | 184 | 82 | 1 |
| 10 | 10 | T/3528-12 | T494T106(1)010A(2) | 1.0 | 6.0 | 3.5 | 141 | 127 | 56 | 1 |
| 10 | 10 | S/3216-12 | T494S106(M)010A(2) | 1.0 | 10.0 | 12.0 | 71 | 64 | 28 | 1 |
| 10 | 10 | R/2012-12 | T494R106(M)010A(2) | 1.0 | 24.0 | 25.0 | 32 | 29 | 13 | 1 |
| 10 | 15 | C/6032-28 | T494C156(1)010A(2) | 1.5 | 6.0 | 0.5 | 469 | 422 | 188 | 1 |
| 10 | 15 | U/6032-15 | T494U156(1)010A(2) | 1.5 | 6.0 | 0.8 | 335 | 302 | 134 | 1 |
| 10 | 15 | B/3528-21 | T494B156(1)010A(2) | 1.5 | 6.0 | 0.7 | 348 | 313 | 139 | 1 |
| 10 | 15 | A/3216-18 | T494A156(1)010A(2) | 1.5 | 8.0 | 4.0 | 137 | 123 | 55 | 1 |
| 10 | 15 | T/3528-12 | T494T156(M)010A(2) | 1.5 | 8.0 | 3.5 | 141 | 127 | 56 | 1 |
| 10 | 22 | C/6032-28 | T494C226(1)010A(2) | 2.2 | 6.0 | 0.4 | 524 | 472 | 210 | 1 |
| 10 | 22 | U/6032-15 | T494U226(1)010A(2) | 2.2 | 6.0 | 0.8 | 335 | 302 | 134 | 1 |
| 10 | 22 | B/3528-21 | T494B226(1)010A(2) | 2.2 | 6.0 | 0.7 | 348 | 313 | 139 | 1 |
| 10 | 22 | A/3216-18 | T494A226(M)010A(2) | 2.2 | 10.0 | 4.5 | 129 | 116 | 52 | 1 |
| 10 | 22 | T/3528-12 | T494T226(M)010A(2) | 2.2 | 12.0 | 6.0 | 108 | 97 | 43 | 1 |
| 10 | 33 | D/7343-31 | T494D336(1)010A(2) | 3.3 | 6.0 | 0.25 | 775 | 698 | 310 | 1 |
| 10 | 33 | V/7343-20 | T494V336(1)010A(2) | 3.3 | 6.0 | 0.30 | 645 | 581 | 258 | 1 |
| 10 | 33 | C/6032-28 | T494C336(1)010A(2) | 3.3 | 6.0 | 0.30 | 606 | 545 | 242 | 1 |
| 10 | 33 | U/6032-15 | T494U336(1)010A(2) | 3.3 | 6.0 | 0.60 | 387 | 348 | 155 | 1 |
| 10 | 33 | T/3528-12 | T494T336(1)010A(2) | 3.3 | 24.0 | 3.75 | 137 | 123 | 55 | 1 |
| 10 | 33 | B/3528-21 | T494B336(1)010A(2) | 3.3 | 6.0 | 1.40 | 246 | 221 | 98 | 1 |
| VDC | µF | KEMET/EIA | (See below for part options) | max/5min | % Max | Ohms | mAmps | mAmps | mAmps | J-STD-020D |
| Rated Voltage | Rated Cap | Case Code/ Case Size | KEMET Part Number | DC Leakage | DF | ESR | Maximum Allowable Ripple Current | | | Moisture Sensitivity |

(1) To complete KEMET part number, insert M for ± 20% or K for ± 10%. Designates Capacitance tolerance.

(2) To complete KEMET part number, insert T = 100% Matte Tin (Sn) Plated, G = Gold Plated, H = Standard Solder coated (SnPb 5% Pb minimum). Designates Termination Finish.

Refer to Ordering Information for additional detail.

Higher voltage ratings and tighter tolerance product including ESR may be substituted within the same size at KEMET's option. Voltage substitution will be marked with the higher voltage rating. Substitutions can include better than series.

Table 1 – Ratings & Part Number Reference con't

| Rated Voltage | Rated Cap | Case Code/ Case Size | KEMET Part Number | DC Leakage | DF | ESR | Maximum Allowable Ripple Current | | | Moisture Sensitivity |
|---------------|-----------|-------------------------|------------------------------|-------------|-------------|--------------|----------------------------------|--------------|---------------|----------------------|
| | | | | | | | +25°C 100kHz | +85°C 100kHz | +125°C 100kHz | |
| VDC | 120Hz | KEMET/EIA | (See below for part options) | μAmps +20°C | +20°C 120Hz | +20°C 100kHz | +25°C 100kHz | +85°C 100kHz | +125°C 100kHz | Temp≤260°C |
| | μF | | | max/5min | % Max | Ohms | mAmps | mAmps | mAmps | J-STD-020D |
| 10 | 33 | A/3216-18 | T494A336(1)010A(2) | 3.3 | 15.0 | 4.00 | 137 | 123 | 55 | 1 |
| 10 | 47 | D/7343-31 | T494D476(1)010A(2) | 4.7 | 6.0 | 0.22 | 826 | 743 | 330 | 1 |
| 10 | 47 | V/7343-20 | T494V476(1)010A(2) | 4.7 | 6.0 | 0.30 | 645 | 581 | 258 | 1 |
| 10 | 47 | C/6032-28 | T494C476(1)010A(2) | 4.7 | 6.0 | 0.30 | 606 | 545 | 242 | 1 |
| 10 | 47 | U/6032-15 | T494U476(1)010A(2) | 4.7 | 10.0 | 1.20 | 274 | 247 | 110 | 1 |
| 10 | 47 | B/3528-21 | T494B476(M)010A(2) | 4.7 | 8.0 | 0.65 | 362 | 326 | 145 | 1 |
| 10 | 68 | D/7343-31 | T494D686(1)010A(2) | 6.8 | 6.0 | 0.20 | 866 | 779 | 346 | 1 |
| 10 | 68 | C/6032-28 | T494C686(1)010A(2) | 6.8 | 6.0 | 0.30 | 606 | 545 | 242 | 1 |
| 10 | 68 | V/7343-20 | T494V686(1)010A(2) | 6.8 | 6.0 | 0.30 | 645 | 581 | 258 | 1 |
| 10 | 68 | U/6032-15 | T494U686(M)010A(2) | 6.8 | 10.0 | 1.20 | 274 | 247 | 110 | 1 |
| 10 | 68 | B/3528-21 | T494B686(M)010A(2) | 6.8 | 10.0 | 1.50 | 238 | 214 | 95 | 1 |
| 10 | 100 | D/7343-31 | T494D107(1)010A(2) | 10.0 | 8.0 | 0.15 | 1000 | 900 | 400 | 1 |
| 10 | 100 | C/6032-28 | T494C107(1)010A(2) | 10.0 | 8.0 | 0.20 | 742 | 668 | 297 | 1 |
| 10 | 100 | V/7343-20 | T494V107(1)010A(2) | 10.0 | 8.0 | 0.40 | 559 | 503 | 224 | 1 |
| 10 | 150 | X/7343-43 | T494X157(1)010A(2) | 15.0 | 8.0 | 0.15 | 1049 | 944 | 420 | 1 |
| 10 | 150 | D/7343-31 | T494D157(1)010A(2) | 15.0 | 8.0 | 0.15 | 1000 | 900 | 400 | 1 |
| 10 | 150 | C/6032-28 | T494C157(1)010A(2) | 15.0 | 10.0 | 0.70 | 396 | 356 | 158 | 1 |
| 10 | 150 | V/7343-20 | T494V157(M)010A(2) | 15.0 | 8.0 | 0.30 | 645 | 581 | 258 | 1 |
| 10 | 220 | X/7343-43 | T494X227(1)010A(2) | 22.0 | 8.0 | 0.15 | 1049 | 944 | 420 | 1 |
| 10 | 220 | D/7343-31 | T494D227(1)010A(2) | 22.0 | 8.0 | 0.15 | 1000 | 900 | 400 | 1 |
| 10 | 330 | X/7343-43 | T494X337(1)010A(2) | 33.0 | 10.0 | 0.10 | 1285 | 1157 | 514 | 1 |
| 10 | 330 | D/7343-31 | T494D337(M)010A(2) | 33.0 | 10.0 | 0.15 | 1000 | 900 | 400 | 1 |
| 10 | 330 | E/7260-38 | T494E337(1)010A(2) | 33.0 | 10.0 | 0.25 | 894 | 805 | 358 | 1 |
| 10 | 470 | X/7343-43 | T494X477(M)010A(2) | 47.0 | 10.0 | 0.10 | 1285 | 1157 | 514 | 1 |
| 10 | 470 | E/7260-38 | T494E477(M)010A(2) | 47.0 | 12.0 | 0.10 | 1414 | 1273 | 566 | 1 |
| 16 | 1 | A/3216-18 | T494A105(1)016A(2) | 0.2 | 4.0 | 6.0 | 112 | 101 | 45 | 1 |
| 16 | 1.5 | A/3216-18 | T494A155(1)016A(2) | 0.2 | 6.0 | 6.0 | 112 | 101 | 45 | 1 |
| 16 | 2.2 | A/3216-18 | T494A225(1)016A(2) | 0.4 | 6.0 | 4.0 | 137 | 123 | 55 | 1 |
| 16 | 2.2 | S/3216-12 | T494S225(1)016A(2) | 0.4 | 6.0 | 10.0 | 77 | 69 | 31 | 1 |
| 16 | 2.2 | R/2012-12 | T494R225(1)016A(2) | 0.4 | 8.0 | 20.0 | 35 | 32 | 14 | 1 |
| 16 | 3.3 | B/3528-21 | T494B335(1)016A(2) | 0.5 | 6.0 | 2.0 | 206 | 185 | 82 | 1 |
| 16 | 3.3 | A/3216-18 | T494A335(1)016A(2) | 0.5 | 6.0 | 4.0 | 137 | 123 | 55 | 1 |
| 16 | 4.7 | B/3528-21 | T494B475(1)016A(2) | 0.8 | 6.0 | 1.5 | 238 | 214 | 95 | 1 |
| 16 | 4.7 | A/3216-18 | T494A475(1)016A(2) | 0.8 | 6.0 | 3.0 | 158 | 142 | 63 | 1 |
| 16 | 4.7 | T/3528-12 | T494T475(1)016A(2) | 0.8 | 6.0 | 3.0 | 153 | 138 | 61 | 1 |
| 16 | 6.8 | C/6032-28 | T494C685(1)016A(2) | 1.1 | 6.0 | 0.8 | 371 | 334 | 148 | 1 |
| 16 | 6.8 | B/3528-21 | T494B685(1)016A(2) | 1.1 | 6.0 | 1.2 | 266 | 239 | 106 | 1 |
| 16 | 6.8 | A/3216-18 | T494A685(1)016A(2) | 1.1 | 6.0 | 3.0 | 158 | 142 | 63 | 1 |
| 16 | 10 | C/6032-28 | T494C106(1)016A(2) | 1.6 | 6.0 | 0.6 | 428 | 385 | 171 | 1 |
| 16 | 10 | U/6032-15 | T494U106(1)016A(2) | 1.6 | 6.0 | 1.0 | 300 | 270 | 120 | 1 |
| 16 | 10 | B/3528-21 | T494B106(1)016A(2) | 1.6 | 6.0 | 0.8 | 326 | 293 | 130 | 1 |
| 16 | 10 | A/3216-18 | T494A106(1)016A(2) | 1.6 | 8.0 | 3.0 | 158 | 142 | 63 | 1 |
| 16 | 10 | T/3528-12 | T494T106(1)016A(2) | 1.6 | 8.0 | 6.0 | 108 | 97 | 43 | 1 |
| 16 | 15 | C/6032-28 | T494C156(1)016A(2) | 2.4 | 6.0 | 0.4 | 524 | 472 | 210 | 1 |
| 16 | 15 | U/6032-15 | T494U156(1)016A(2) | 2.4 | 6.0 | 0.8 | 335 | 302 | 134 | 1 |
| 16 | 15 | B/3528-21 | T494B156(1)016A(2) | 2.4 | 6.0 | 0.8 | 326 | 293 | 130 | 1 |
| 16 | 22 | D/7343-31 | T494D226(1)016A(2) | 3.5 | 6.0 | 0.25 | 775 | 698 | 310 | 1 |
| 16 | 22 | C/6032-28 | T494C226(1)016A(2) | 3.5 | 6.0 | 0.35 | 561 | 505 | 224 | 1 |
| 16 | 22 | U/6032-15 | T494U226(1)016A(2) | 3.5 | 10.0 | 1.80 | 224 | 202 | 90 | 1 |
| 16 | 22 | B/3528-21 | T494B226(1)016A(2) | 3.5 | 6.0 | 1.00 | 292 | 263 | 117 | 1 |
| 16 | 33 | D/7343-31 | T494D336(1)016A(2) | 5.3 | 6.0 | 0.25 | 775 | 698 | 310 | 1 |
| VDC | μF | KEMET/EIA | (See below for part options) | max/5min | % Max | Ohms | mAmps | mAmps | mAmps | J-STD-020D |
| | 120Hz | | | μAmps +20°C | +20°C 120Hz | +20°C 100kHz | +25°C 100kHz | +85°C 100kHz | +125°C 100kHz | Temp≤260°C |
| Rated Voltage | Rated Cap | Case Code/ Case Size | KEMET Part Number | DC Leakage | DF | ESR | Maximum Allowable Ripple Current | | | Moisture Sensitivity |

(1) To complete KEMET part number, insert M for ± 20% or K for ± 10%. Designates Capacitance tolerance.

(2) To complete KEMET part number, insert T = 100% Matte Tin (Sn) Plated, G = Gold Plated, H = Standard Solder coated (SnPb 5% Pb minimum). Designates Termination Finish.

Refer to Ordering Information for additional detail.

Higher voltage ratings and tighter tolerance product including ESR may be substituted within the same size at KEMET's option. Voltage substitution will be marked with the higher voltage rating. Substitutions can include better than series.

Table 1 – Ratings & Part Number Reference con't

| Rated Voltage | Rated Cap | Case Code/ Case Size | KEMET Part Number | DC Leakage | DF | ESR | Maximum Allowable Ripple Current | | | Moisture Sensitivity |
|---------------|-----------|-------------------------|------------------------------|-------------|-------------|--------------|----------------------------------|--------------|---------------|----------------------|
| | | | | | | | +25°C 100kHz | +85°C 100kHz | +125°C 100kHz | |
| VDC | 120Hz | KEMET/EIA | (See below for part options) | μAmps +20°C | +20°C 120Hz | +20°C 100kHz | +25°C 100kHz | +85°C 100kHz | +125°C 100kHz | Temp≤260°C |
| | μF | | | max/5min | % Max | Ohms | mAmps | mAmps | mAmps | J-STD-020D |
| 16 | 33 | C/6032-28 | T494C336(1)016A(2) | 5.3 | 6.0 | 0.30 | 606 | 545 | 242 | 1 |
| 16 | 33 | U/6032-15 | T494U336(1)016A(2) | 5.3 | 12.0 | 2.20 | 202 | 182 | 81 | 1 |
| 16 | 33 | B/3528-21 | T494B336(1)016A(2) | 5.3 | 8.0 | 1.20 | 266 | 239 | 106 | 1 |
| 16 | 47 | D/7343-31 | T494D476(1)016A(2) | 7.5 | 6.0 | 0.2 | 866 | 779 | 346 | 1 |
| 16 | 47 | V/7343-20 | T494V476(1)016A(2) | 7.5 | 6.0 | 0.3 | 645 | 581 | 258 | 1 |
| 16 | 47 | C/6032-28 | T494C476(1)016A(2) | 7.5 | 6.0 | 0.5 | 469 | 422 | 188 | 1 |
| 16 | 68 | D/7343-31 | T494D686(1)016A(2) | 10.9 | 6.0 | 0.15 | 1000 | 900 | 400 | 1 |
| 16 | 68 | V/7343-20 | T494V686(1)016A(2) | 10.9 | 6.0 | 0.5 | 500 | 450 | 200 | 1 |
| 16 | 68 | C/6032-28 | T494C686(1)016A(2) | 10.9 | 12.0 | 1.0 | 332 | 299 | 133 | 1 |
| 16 | 100 | X/7343-43 | T494X107(1)016A(2) | 16.0 | 8.0 | 0.15 | 1049 | 944 | 420 | 1 |
| 16 | 100 | D/7343-31 | T494D107(1)016A(2) | 16.0 | 8.0 | 0.15 | 1000 | 900 | 400 | 1 |
| 16 | 100 | V/7343-20 | T494V107(1)016A(2) | 16.0 | 12.0 | 0.5 | 500 | 450 | 200 | 1 |
| 16 | 150 | X/7343-43 | T494X157(1)016A(2) | 24.0 | 8.0 | 0.15 | 1049 | 944 | 420 | 1 |
| 16 | 150 | D/7343-31 | T494D157(1)016A(2) | 24.0 | 12.0 | 0.4 | 612 | 551 | 245 | 1 |
| 16 | 220 | X/7343-43 | T494X227(1)016A(2) | 35.2 | 10.0 | 0.4 | 642 | 578 | 257 | 1 |
| 16 | 220 | E/7260-38 | T494E227(1)016A(2) | 35.2 | 7.2 | 0.5 | 632 | 569 | 253 | 1 |
| 20 | 0.68 | A/3216-18 | T494A684(1)020A(2) | 0.1 | 4.0 | 8.0 | 97 | 87 | 39 | 1 |
| 20 | 1 | A/3216-18 | T494A105(1)020A(2) | 0.2 | 4.0 | 5.5 | 117 | 105 | 47 | 1 |
| 20 | 1 | S/3216-12 | T494S105(1)020A(2) | 0.2 | 6.0 | 10.0 | 77 | 69 | 31 | 1 |
| 20 | 1 | R/2012-12 | T494R105(1)020A(2) | 0.2 | 6.0 | 15.0 | 41 | 37 | 16 | 1 |
| 20 | 1.5 | A/3216-18 | T494A155(1)020AS(2) | 0.3 | 6.0 | 4.5 | 129 | 116 | 52 | 1 |
| 20 | 1.5 | S/3216-12 | T494S155(1)020A(2) | 0.3 | 6.0 | 9.0 | 82 | 74 | 33 | 1 |
| 20 | 2.2 | B/3528-21 | T494B225(1)020A(2) | 0.4 | 6.0 | 1.5 | 238 | 214 | 95 | 1 |
| 20 | 2.2 | A/3216-18 | T494A225(1)020A(2) | 0.4 | 6.0 | 4.0 | 137 | 123 | 55 | 1 |
| 20 | 2.2 | R/2012-12 | T494R225(1)020A(2) | 0.4 | 8.0 | 6.0 | 65 | 59 | 26 | 1 |
| 20 | 3.3 | B/3528-21 | T494B335(1)020A(2) | 0.7 | 6.0 | 1.3 | 256 | 230 | 102 | 1 |
| 20 | 3.3 | A/3216-18 | T494A335(1)020A(2) | 0.7 | 6.0 | 4.0 | 137 | 123 | 55 | 1 |
| 20 | 3.3 | T/3528-12 | T494T335(1)020A(2) | 0.7 | 6.0 | 4.0 | 132 | 119 | 53 | 1 |
| 20 | 4.7 | C/6032-28 | T494C475(1)020A(2) | 0.9 | 6.0 | 0.6 | 428 | 385 | 171 | 1 |
| 20 | 4.7 | B/3528-21 | T494B475(1)020A(2) | 0.9 | 6.0 | 1.0 | 292 | 263 | 117 | 1 |
| 20 | 4.7 | A/3216-18 | T494A475(1)020A(2) | 0.9 | 6.0 | 3.0 | 158 | 142 | 63 | 1 |
| 20 | 6.8 | C/6032-28 | T494C685(1)020A(2) | 1.4 | 6.0 | 0.6 | 428 | 385 | 171 | 1 |
| 20 | 6.8 | U/6032-15 | T494U685(1)020A(2) | 1.4 | 6.0 | 1.4 | 254 | 229 | 102 | 1 |
| 20 | 6.8 | B/3528-21 | T494B685(1)020A(2) | 1.4 | 6.0 | 1.0 | 292 | 263 | 117 | 1 |
| 20 | 6.8 | A/3216-18 | T494A685(M)020A(2) | 1.4 | 8.0 | 3.0 | 158 | 142 | 63 | 1 |
| 20 | 10 | C/6032-28 | T494C106(1)020A(2) | 2.0 | 6.0 | 0.5 | 469 | 422 | 188 | 1 |
| 20 | 10 | U/6032-15 | T494U106(1)020A(2) | 2.0 | 6.0 | 0.8 | 335 | 302 | 134 | 1 |
| 20 | 10 | B/3528-21 | T494B106(1)020A(2) | 2.0 | 6.0 | 1.0 | 292 | 263 | 117 | 1 |
| 20 | 10 | A/3216-18 | T494A106(M)020A(2) | 2.0 | 10.0 | 3.0 | 158 | 142 | 63 | 1 |
| 20 | 15 | D/7343-31 | T494D156(1)020A(2) | 3.0 | 6.0 | 0.35 | 655 | 590 | 262 | 1 |
| 20 | 15 | C/6032-28 | T494C156(1)020A(2) | 3.0 | 6.0 | 0.40 | 524 | 472 | 210 | 1 |
| 20 | 22 | D/7343-31 | T494D226(1)020A(2) | 4.4 | 6.0 | 0.3 | 707 | 636 | 283 | 1 |
| 20 | 22 | V/7343-20 | T494V226(1)020A(2) | 4.4 | 6.0 | 0.4 | 559 | 503 | 224 | 1 |
| 20 | 22 | C/6032-28 | T494C226(1)020A(2) | 4.4 | 6.0 | 0.4 | 524 | 472 | 210 | 1 |
| 20 | 22 | B/3528-21 | T494B226(1)020A(2) | 4.4 | 8.0 | 3.0 | 168 | 151 | 67 | 1 |
| 20 | 33 | D/7343-31 | T494D336(1)020A(2) | 6.6 | 6.0 | 0.25 | 775 | 698 | 310 | 1 |
| 20 | 33 | C/6032-28 | T494C336(M)020A(2) | 6.6 | 6.0 | 0.40 | 524 | 472 | 210 | 1 |
| 20 | 33 | V/7343-20 | T494V336(1)020A(2) | 6.6 | 8.0 | 0.40 | 559 | 503 | 224 | 1 |
| 20 | 33 | B/3528-21 | T494B336(M)020A(2) | 6.6 | 10.0 | 3.00 | 168 | 151 | 67 | 1 |
| 20 | 47 | C/6032-28 | T494C476(M)020A(2) | 9.4 | 10.0 | 0.80 | 371 | 334 | 148 | 1 |
| 20 | 47 | D/7343-31 | T494D476(1)020A(2) | 9.4 | 6.0 | 0.20 | 866 | 779 | 346 | 1 |
| VDC | μF | KEMET/EIA | (See below for part options) | max/5min | % Max | Ohms | mAmps | mAmps | mAmps | J-STD-020D |
| | 120Hz | | | μAmps +20°C | +20°C 120Hz | +20°C 100kHz | +25°C 100kHz | +85°C 100kHz | +125°C 100kHz | Temp≤260°C |
| Rated Voltage | Rated Cap | Case Code/ Case Size | KEMET Part Number | DC Leakage | DF | ESR | Maximum Allowable Ripple Current | | | Moisture Sensitivity |

(1) To complete KEMET part number, insert M for ± 20% or K for ± 10%. Designates Capacitance tolerance.

(2) To complete KEMET part number, insert T = 100% Matte Tin (Sn) Plated, G = Gold Plated, H = Standard Solder coated (SnPb 5% Pb minimum). Designates Termination Finish.

Refer to Ordering Information for additional detail.

Higher voltage ratings and tighter tolerance product including ESR may be substituted within the same size at KEMET's option. Voltage substitution will be marked with the higher voltage rating. Substitutions can include better than series.

Table 1 – Ratings & Part Number Reference con't

| Rated Voltage | Rated Cap | Case Code/ Case Size | KEMET Part Number | DC Leakage | DF | ESR | Maximum Allowable Ripple Current | | | Moisture Sensitivity |
|---------------|-----------|-------------------------|------------------------------|-------------------------|-------------------|--------------|----------------------------------|--------------|---------------|----------------------|
| | | | | | | | +25°C 100kHz | +85°C 100kHz | +125°C 100kHz | |
| VDC | 120Hz | KEMET/EIA | (See below for part options) | μAmps +20°C | +20°C 120Hz | +20°C 100kHz | +25°C 100kHz | +85°C 100kHz | +125°C 100kHz | Temp≤260°C |
| | μF | | | max/5min | % Max | Ohms | mAmps | mAmps | mAmps | J-STD-020D |
| 20 | 68 | X/7343-43 | T494X686(1)020A(2) | 13.6 | 6.0 | 0.20 | 908 | 817 | 363 | 1 |
| 20 | 68 | D/7343-31 | T494D686(1)020A(2) | 13.6 | 8.0 | 0.20 | 866 | 779 | 346 | 1 |
| 20 | 100 | X/7343-43 | T494X107(1)020A(2) | 20.0 | 8.0 | 0.15 | 1049 | 944 | 420 | 1 |
| 20 | 100 | E/7260-38 | T494E107(1)020A(2) | 20.0 | 8.0 | 0.30 | 816 | 734 | 326 | 1 |
| 20 | 150 | X/7343-43 | T494X157(1)020A(2) | 30.0 | 10.0 | 0.30 | 742 | 668 | 297 | 1 |
| 25 | 0.33 | A/3216-18 | T494A334(1)025A(2) | 0.1 | 4.0 | 10.0 | 87 | 78 | 35 | 1 |
| 25 | 0.47 | A/3216-18 | T494A474(1)025A(2) | 0.1 | 4.0 | 9.0 | 91 | 82 | 36 | 1 |
| 25 | 0.68 | A/3216-18 | T494A684(1)025A(2) | 0.2 | 4.0 | 6.0 | 112 | 101 | 45 | 1 |
| 25 | 1 | B/3528-21 | T494B105(1)025A(2) | 0.3 | 4.0 | 2.0 | 206 | 185 | 82 | 1 |
| 25 | 1 | A/3216-18 | T494A105(1)025A(2) | 0.3 | 4.0 | 4.0 | 137 | 123 | 55 | 1 |
| 25 | 1.5 | B/3528-21 | T494B155(1)025A(2) | 0.4 | 6.0 | 1.5 | 238 | 214 | 95 | 1 |
| 25 | 1.5 | A/3216-18 | T494A155(1)025A(2) | 0.4 | 6.0 | 3.0 | 158 | 142 | 63 | 1 |
| 25 | 1.5 | R/2012-12 | T494R155(1)025A(2) | 0.4 | 8.0 | 6.0 | 65 | 59 | 26 | 1 |
| 25 | 2.2 | C/6032-28 | T494C225(1)025A(2) | 0.6 | 6.0 | 2.2 | 224 | 202 | 90 | 1 |
| 25 | 2.2 | B/3528-21 | T494B225(1)025A(2) | 0.6 | 6.0 | 1.2 | 266 | 239 | 106 | 1 |
| 25 | 2.2 | A/3216-18 | T494A225(1)025A(2) | 0.6 | 6.0 | 3.0 | 158 | 142 | 63 | 1 |
| 25 | 3.3 | C/6032-28 | T494C335(1)025A(2) | 0.8 | 6.0 | 1.2 | 303 | 273 | 121 | 1 |
| 25 | 3.3 | B/3528-21 | T494B335(1)025A(2) | 0.8 | 6.0 | 2.0 | 206 | 185 | 82 | 1 |
| 25 | 3.3 | A/3216-18 | T494A335(1)025A(2) | 0.8 | 6.0 | 3.0 | 158 | 142 | 63 | 1 |
| 25 | 4.7 | C/6032-28 | T494C475(1)025A(2) | 1.2 | 6.0 | 0.6 | 428 | 385 | 171 | 1 |
| 25 | 4.7 | B/3528-21 | T494B475(1)025A(2) | 1.2 | 6.0 | 1.0 | 292 | 263 | 117 | 1 |
| 25 | 4.7 | A/3216-18 | T494A475(M)025A(2) | 1.2 | 8.0 | 3.0 | 158 | 142 | 63 | 1 |
| 25 | 6.8 | C/6032-28 | T494C685(1)025A(2) | 1.7 | 6.0 | 0.6 | 428 | 385 | 171 | 1 |
| 25 | 6.8 | B/3528-21 | T494B685(1)025A(2) | 1.7 | 8.0 | 2.0 | 206 | 185 | 82 | 1 |
| 25 | 10 | D/7343-31 | T494D106(1)025A(2) | 2.5 | 6.0 | 0.4 | 612 | 551 | 245 | 1 |
| 25 | 10 | C/6032-28 | T494C106(1)025A(2) | 2.5 | 6.0 | 0.6 | 428 | 385 | 171 | 1 |
| 25 | 10 | B/3528-21 | T494B106(1)025A(2) | 2.5 | 8.0 | 3.0 | 168 | 151 | 67 | 1 |
| 25 | 15 | D/7343-31 | T494D156(1)025A(2) | 3.8 | 6.0 | 0.35 | 655 | 590 | 262 | 1 |
| 25 | 15 | C/6032-28 | T494C156(1)025A(2) | 3.8 | 6.0 | 0.90 | 350 | 315 | 140 | 1 |
| 25 | 15 | B/3528-21 | T494B156(1)025A(2) | 3.8 | 8.0 | 3.00 | 168 | 151 | 67 | 1 |
| 25 | 22 | D/7343-31 | T494D226(1)025A(2) | 5.5 | 6.0 | 0.3 | 707 | 636 | 283 | 1 |
| 25 | 22 | C/6032-28 | T494C226(1)025A(2) | 5.5 | 6.0 | 1.0 | 332 | 299 | 133 | 1 |
| 25 | 22 | V/7343-20 | T494V226(1)025A(2) | 5.5 | 6.0 | 0.5 | 500 | 450 | 200 | 1 |
| 25 | 33 | X/7343-43 | T494X336(1)025A(2) | 8.3 | 6.0 | 0.3 | 742 | 668 | 297 | 1 |
| 25 | 33 | D/7343-31 | T494D336(1)025A(2) | 8.3 | 6.0 | 0.4 | 612 | 551 | 245 | 1 |
| 25 | 33 | C/6032-28 | T494C336(1)025A(2) | 8.3 | 10.0 | 1.0 | 332 | 299 | 133 | 1 |
| 25 | 47 | X/7343-43 | T494X476(1)025A(2) | 11.8 | 6.0 | 0.3 | 742 | 668 | 297 | 1 |
| 25 | 47 | D/7343-31 | T494D476(1)025A(2) | 11.8 | 10.0 | 0.2 | 866 | 779 | 346 | 1 |
| 25 | 68 | X/7343-43 | T494X686(M)025A(2) | 17.0 | 8.0 | 0.3 | 742 | 668 | 297 | 1 |
| 25 | 68 | D/7343-31 | T494D686(M)025A(2) | 17.0 | 10.0 | 0.5 | 548 | 493 | 219 | 1 |
| 25 | 100 | X/7343-43 | T494X107(M)025A(2) | 25.0 | 8.0 | 0.25 | 812 | 731 | 325 | 1 |
| 35 | 0.1 | A/3216-18 | T494A104(1)035A(2) | 0.0 | 4.0 | 10.0 | 87 | 78 | 35 | 1 |
| 35 | 0.15 | A/3216-18 | T494A154(1)035A(2) | 0.1 | 4.0 | 6.0 | 112 | 101 | 45 | 1 |
| 35 | 0.22 | A/3216-18 | T494A224(1)035A(2) | 0.1 | 4.0 | 6.0 | 112 | 101 | 45 | 1 |
| 35 | 0.33 | A/3216-18 | T494A334(1)035A(2) | 0.1 | 4.0 | 6.0 | 112 | 101 | 45 | 1 |
| 35 | 0.47 | B/3528-21 | T494B474(1)035A(2) | 0.2 | 4.0 | 2.5 | 184 | 166 | 74 | 1 |
| 35 | 0.47 | A/3216-18 | T494A474(1)035A(2) | 0.2 | 4.0 | 4.0 | 137 | 123 | 55 | 1 |
| 35 | 0.68 | B/3528-21 | T494B684(1)035A(2) | 0.2 | 4.0 | 2.5 | 184 | 166 | 74 | 1 |
| 35 | 0.68 | A/3216-18 | T494A684(1)035A(2) | 0.2 | 4.0 | 6.0 | 112 | 101 | 45 | 1 |
| 35 | 1 | B/3528-21 | T494B105(1)035A(2) | 0.4 | 4.0 | 2.0 | 206 | 185 | 82 | 1 |
| VDC | μF | KEMET/EIA | (See below for part options) | max/5min | % Max | Ohms | mAmps | mAmps | mAmps | J-STD-020D |
| Rated Voltage | Rated Cap | | | Case Code/ Case Size | KEMET Part Number | μAmps +20°C | +20°C 120Hz | +20°C 100kHz | +25°C 100kHz | +85°C 100kHz |
| Rated Voltage | Rated Cap | Case Code/ Case Size | KEMET Part Number | DC Leakage | DF | ESR | Maximum Allowable Ripple Current | | | Moisture Sensitivity |

(1) To complete KEMET part number, insert M for ± 20% or K for ± 10%. Designates Capacitance tolerance.

(2) To complete KEMET part number, insert T = 100% Matte Tin (Sn) Plated, G = Gold Plated, H = Standard Solder coated (SnPb 5% Pb minimum). Designates Termination Finish.

Refer to Ordering Information for additional detail.

Higher voltage ratings and tighter tolerance product including ESR may be substituted within the same size at KEMET's option. Voltage substitution will be marked with the higher voltage rating. Substitutions can include better than series.

Table 1 – Ratings & Part Number Reference con't

| Rated Voltage | Rated Cap | Case Code/ Case Size | KEMET Part Number | DC Leakage | DF | ESR | Maximum Allowable Ripple Current | | | Moisture Sensitivity |
|---------------|-----------|-------------------------|------------------------------|-------------|-------------|--------------|----------------------------------|--------------|---------------|----------------------|
| | | | | | | | +25°C 100kHz | +85°C 100kHz | +125°C 100kHz | |
| VDC | 120Hz | KEMET/EIA | (See below for part options) | μAmps +20°C | +20°C 120Hz | +20°C 100kHz | +25°C 100kHz | +85°C 100kHz | +125°C 100kHz | Temp≤260°C |
| | μF | | | max/5min | % Max | Ohms | mAmps | mAmps | mAmps | J-STD-020D |
| 35 | 1 | A/3216-18 | T494A105(1)035A(2) | 0.4 | 4.0 | 6.0 | 112 | 101 | 45 | 1 |
| 35 | 1.5 | C/6032-28 | T494C155(1)035A(2) | 0.5 | 6.0 | 2.5 | 210 | 189 | 84 | 1 |
| 35 | 1.5 | B/3528-21 | T494B155(1)035A(2) | 0.5 | 6.0 | 3.0 | 168 | 151 | 67 | 1 |
| 35 | 2.2 | C/6032-28 | T494C225(1)035A(2) | 0.8 | 6.0 | 1.5 | 271 | 244 | 108 | 1 |
| 35 | 2.2 | B/3528-21 | T494B225(1)035A(2) | 0.8 | 6.0 | 2.5 | 184 | 166 | 74 | 1 |
| 35 | 3.3 | C/6032-28 | T494C335(1)035A(2) | 1.2 | 6.0 | 0.8 | 371 | 334 | 148 | 1 |
| 35 | 3.3 | B/3528-21 | T494B335(1)035A(2) | 1.2 | 6.0 | 1.3 | 256 | 230 | 102 | 1 |
| 35 | 4.7 | D/7343-31 | T494D475(1)035A(2) | 1.6 | 6.0 | 0.7 | 463 | 417 | 185 | 1 |
| 35 | 4.7 | C/6032-28 | T494C475(1)035A(2) | 1.6 | 6.0 | 0.7 | 396 | 356 | 158 | 1 |
| 35 | 6.8 | D/7343-31 | T494D685(1)035A(2) | 2.4 | 6.0 | 0.5 | 548 | 493 | 219 | 1 |
| 35 | 6.8 | C/6032-28 | T494C685(1)035A(2) | 2.4 | 6.0 | 0.9 | 350 | 315 | 140 | 1 |
| 35 | 10 | D/7343-31 | T494D106(1)035A(2) | 3.5 | 6.0 | 0.4 | 612 | 551 | 245 | 1 |
| 35 | 10 | C/6032-28 | T494C106(M)035A(2) | 3.5 | 6.0 | 1.2 | 303 | 273 | 121 | 1 |
| 35 | 10 | V/7343-20 | T494V106(1)035A(2) | 3.5 | 6.0 | 0.8 | 395 | 356 | 158 | 1 |
| 35 | 15 | X/7343-43 | T494X156(1)035A(2) | 5.3 | 6.0 | 0.30 | 742 | 668 | 297 | 1 |
| 35 | 15 | D/7343-31 | T494D156(1)035A(2) | 5.3 | 6.0 | 0.35 | 655 | 590 | 262 | 1 |
| 35 | 22 | X/7343-43 | T494X226(1)035A(2) | 7.7 | 6.0 | 0.3 | 742 | 668 | 297 | 1 |
| 35 | 22 | D/7343-31 | T494D226(1)035A(2) | 7.7 | 6.0 | 0.4 | 612 | 551 | 245 | 1 |
| 35 | 33 | D/7343-31 | T494D336(1)035A(2) | 11.6 | 6.0 | 0.6 | 500 | 450 | 200 | 1 |
| 35 | 33 | X/7343-43 | T494X336(1)035A(2) | 11.6 | 6.0 | 0.6 | 524 | 472 | 210 | 1 |
| 35 | 47 | X/7343-43 | T494X476(1)035A(2) | 16.5 | 8.0 | 0.5 | 574 | 517 | 230 | 1 |
| 35 | 47 | E/7260-38 | T494E476(1)035A(2) | 16.5 | 10.0 | 0.3 | 816 | 734 | 326 | 1 |
| 50 | 0.1 | A/3216-18 | T494A104(1)050A(2) | 0.1 | 4.0 | 10.0 | 87 | 78 | 35 | 1 |
| 50 | 0.15 | B/3528-21 | T494B154(1)050A(2) | 0.1 | 4.0 | 10.0 | 92 | 83 | 37 | 1 |
| 50 | 0.15 | A/3216-18 | T494A154(1)050A(2) | 0.1 | 4.0 | 10.0 | 87 | 78 | 35 | 1 |
| 50 | 0.22 | B/3528-21 | T494B224(1)050A(2) | 0.1 | 4.0 | 10.0 | 92 | 83 | 37 | 1 |
| 50 | 0.33 | B/3528-21 | T494B334(1)050A(2) | 0.2 | 4.0 | 2.5 | 184 | 166 | 74 | 1 |
| 50 | 0.47 | C/6032-28 | T494C474(1)050A(2) | 0.2 | 4.0 | 1.8 | 247 | 222 | 99 | 1 |
| 50 | 0.47 | B/3528-21 | T494B474(1)050A(2) | 0.2 | 4.0 | 2.0 | 206 | 185 | 82 | 1 |
| 50 | 0.68 | C/6032-28 | T494C684(1)050A(2) | 0.3 | 4.0 | 1.6 | 262 | 236 | 105 | 1 |
| 50 | 0.68 | B/3528-21 | T494B684(1)050A(2) | 0.3 | 4.0 | 3.0 | 168 | 151 | 67 | 1 |
| 50 | 1 | C/6032-28 | T494C105(1)050A(2) | 0.5 | 4.0 | 1.6 | 262 | 236 | 105 | 1 |
| 50 | 1 | B/3528-21 | T494B105(1)050A(2) | 0.5 | 6.0 | 4.0 | 146 | 131 | 58 | 1 |
| 50 | 1 | V/7343-20 | T494V105(M)050A(2) | 0.5 | 4.0 | 4.0 | 177 | 159 | 71 | 1 |
| 50 | 1.5 | D/7343-31 | T494D155(1)050A(2) | 0.8 | 6.0 | 1.0 | 387 | 348 | 155 | 1 |
| 50 | 1.5 | C/6032-28 | T494C155(1)050A(2) | 0.8 | 6.0 | 1.5 | 271 | 244 | 108 | 1 |
| 50 | 2.2 | D/7343-31 | T494D225(1)050A(2) | 1.1 | 6.0 | 0.8 | 433 | 390 | 173 | 1 |
| 50 | 2.2 | C/6032-28 | T494C225(1)050A(2) | 1.1 | 6.0 | 1.5 | 271 | 244 | 108 | 1 |
| 50 | 3.3 | D/7343-31 | T494D335(1)050A(2) | 1.7 | 6.0 | 0.8 | 433 | 390 | 173 | 1 |
| 50 | 4.7 | D/7343-31 | T494D475(1)050A(2) | 2.4 | 6.0 | 0.6 | 500 | 450 | 200 | 1 |
| 50 | 6.8 | X/7343-43 | T494X685(1)050A(2) | 3.4 | 6.0 | 0.5 | 574 | 517 | 230 | 1 |
| 50 | 6.8 | D/7343-31 | T494D685(1)050A(2) | 3.4 | 6.0 | 0.7 | 463 | 417 | 185 | 1 |
| 50 | 10 | X/7343-43 | T494X106(M)050A(2) | 5.0 | 6.0 | 0.4 | 642 | 578 | 257 | 1 |
| 50 | 10 | D/7343-31 | T494D106(1)050A(2) | 5.0 | 6.0 | 0.7 | 463 | 417 | 185 | 1 |
| 50 | 15 | X/7343-43 | T494X156(1)050A(2) | 7.5 | 6.0 | 0.4 | 642 | 578 | 257 | 1 |
| 50 | 22 | X/7343-43 | T494X226(1)050A(2) | 11.0 | 10.0 | 0.5 | 574 | 517 | 230 | 1 |
| VDC | μF | KEMET/EIA | (See below for part options) | max/5min | % Max | Ohms | mAmps | mAmps | mAmps | J-STD-020D |
| | 120Hz | | | μAmps +20°C | +20°C 120Hz | +20°C 100kHz | +25°C 100kHz | +85°C 100kHz | +125°C 100kHz | Temp≤260°C |
| Rated Voltage | Rated Cap | Case Code/ Case Size | KEMET Part Number | DC Leakage | DF | ESR | Maximum Allowable Ripple Current | | | Moisture Sensitivity |

(1) To complete KEMET part number, insert M for ± 20% or K for ± 10%. Designates Capacitance tolerance.

(2) To complete KEMET part number, insert T = 100% Matte Tin (Sn) Plated, G = Gold Plated, H = Standard Solder coated (SnPb 5% Pb minimum). Designates Termination Finish.

Refer to Ordering Information for additional detail.

Higher voltage ratings and tighter tolerance product including ESR may be substituted within the same size at KEMET's option. Voltage substitution will be marked with the higher voltage rating. Substitutions can include better than series.

Recommended Voltage Derating Guidelines

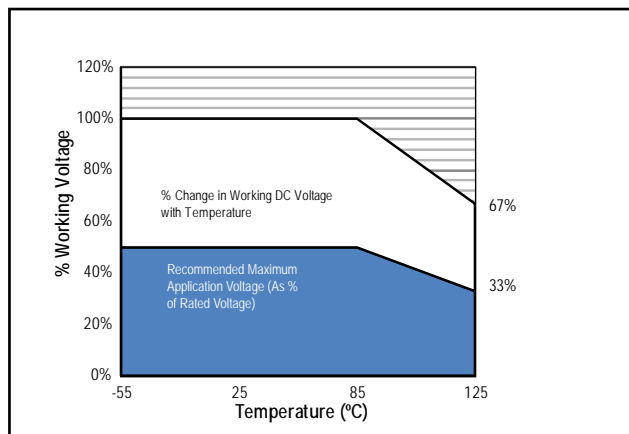

Ripple Current/Ripple Voltage

| Case Code | | Maximum Power Dissipation (Pmax) mWatts @ 25°C w/+20°C Rise |
|-----------|---------|--|
| KEMET | EIA | |
| A | 3216-18 | 75 |
| B | 3528-21 | 85 |
| C | 6032-28 | 110 |
| D | 7343-31 | 150 |
| X | 7343-43 | 165 |
| E | 7260-38 | 200 |
| R | 2012-12 | 25 |
| S | 3216-12 | 60 |
| T | 3528-12 | 70 |
| U | 6032-15 | 90 |
| V | 7343-20 | 125 |
| T510X | 7343-43 | 270 |
| T510E | 7260-38 | 285 |

| Temperature Compensation Multipliers for Maximum Power Dissipation | | |
|---|------|-------|
| ≤25°C | 85°C | 125°C |
| 1.00 | 0.90 | 0.40 |

T = Environmental Temperature

Using the P max of the device, the maximum allowable rms ripple current or voltage may be determined.

$$I(max) = \sqrt{P_{max}/R}$$

$$E(max) = \sqrt{P_{max} \cdot R}$$

I = rms ripple current (amperes)

E = rms ripple voltage (volts)

*P*_{max} = maximum power dissipation (watts)

R = ESR at specified frequency (ohms)

Reverse Voltage

Solid tantalum capacitors are polar devices and may be permanently damaged or destroyed if connected with the wrong polarity. The positive terminal is identified on the capacitor body by a stripe plus in some cases a beveled edge. A small degree of transient reverse voltage is permissible for short periods per the table. The capacitors should not be operated continuously in reverse mode, even within these limits.

| Temperature | Permissible Transient Reverse Voltage |
|-------------|---------------------------------------|
| 25°C | 15% of Rated Voltage |
| 85°C | 5% of Rated Voltage |
| 125°C | 1% of Rated Voltage |

Table 2 – Land Dimensions/Courtyard

| KEMET | Metric Size Code | Density Level A: Maximum (Most) Land Protrusion (mm) | | | | | Density Level B: Median (Nominal) Land Protrusion (mm) | | | | | Density Level C: Minimum (Least) Land Protrusion (mm) | | | | | | |
|----------------|------------------|---|-----|------|------|------|---|------|------|------|------|--|------|------|------|------|------|------|
| | | Case | EIA | X | Y | C | V1 | V2 | X | Y | C | V1 | V2 | X | Y | C | V1 | V2 |
| A | 3216-18 | | | 1.35 | 2.15 | 1.45 | 6.10 | 2.80 | 1.25 | 1.75 | 1.35 | 5.00 | 2.30 | 1.15 | 1.35 | 1.25 | 4.10 | 2.00 |
| B | 3528-21 | | | 2.35 | 2.15 | 1.45 | 6.10 | 4.00 | 2.25 | 1.75 | 1.35 | 5.00 | 3.50 | 2.15 | 1.35 | 1.25 | 4.10 | 3.20 |
| C | 6032-28 | | | 2.35 | 2.65 | 2.60 | 8.90 | 4.40 | 2.25 | 2.25 | 2.50 | 7.80 | 3.90 | 2.15 | 1.85 | 2.40 | 6.90 | 3.60 |
| D | 7343-31 | | | 2.55 | 3.75 | 2.70 | 10.20 | 5.50 | 2.45 | 3.35 | 2.60 | 9.10 | 5.00 | 2.35 | 2.95 | 2.50 | 8.20 | 4.70 |
| E ¹ | 7260-38 | | | 4.25 | 2.65 | 3.20 | 10.10 | 7.20 | 4.15 | 2.25 | 3.30 | 9.40 | 6.70 | 4.05 | 1.85 | 3.00 | 8.10 | 6.40 |
| R | 2012-12 | | | 1.05 | 1.80 | 1.00 | 4.80 | 2.40 | 0.95 | 1.45 | 0.90 | 3.80 | 1.90 | 0.85 | 1.05 | 0.80 | 2.90 | 1.60 |
| S ² | 3216-12 | | | 1.35 | 2.15 | 1.45 | 6.10 | 2.80 | 1.25 | 1.75 | 1.35 | 5.00 | 2.30 | 1.15 | 1.35 | 1.25 | 4.10 | 2.00 |
| T | 3528-12 | | | 2.35 | 2.15 | 1.45 | 6.10 | 4.00 | 2.25 | 1.75 | 1.35 | 5.00 | 3.50 | 2.15 | 1.35 | 1.25 | 4.10 | 3.20 |
| U | 6032-15 | | | 2.55 | 3.75 | 2.70 | 10.20 | 5.50 | 2.45 | 3.35 | 2.60 | 9.10 | 5.00 | 2.35 | 2.95 | 2.50 | 8.20 | 4.70 |
| V | 7343-20 | | | 2.55 | 3.75 | 2.70 | 10.20 | 5.50 | 2.45 | 3.35 | 2.60 | 9.10 | 5.00 | 2.35 | 2.95 | 2.50 | 8.20 | 4.70 |
| X ¹ | 7343-43 | | | 2.55 | 3.75 | 2.70 | 10.20 | 5.50 | 2.45 | 3.35 | 2.60 | 9.10 | 5.00 | 2.35 | 2.95 | 2.50 | 8.20 | 4.70 |

Density Level A: For low-density product applications. Recommended for wave solder applications and provides a wider process window for reflow solder processes.

Density Level B: For products with a moderate level of component density. Provides a robust solder attachment condition for reflow solder processes.

Density Level C: For high component density product applications. Before adapting the minimum land pattern variations the user should perform qualification testing based on the conditions outlined in IPC standard 7351 (IPC-7351).

¹ Height of these chips may create problems in wave soldering.

² Land pattern geometry is too small for silkscreen outline.

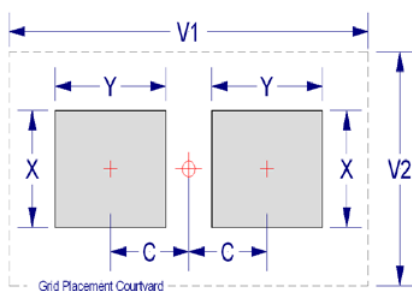

Soldering Process

KEMET's families of surface mount capacitors are compatible with wave (single or dual), convection, IR or vapor phase reflow techniques. Preheating of these components is recommended to avoid extreme thermal stress. KEMET's recommended profile conditions for convection and IR reflow reflect the profile conditions of the IPC/J-STD-020D standard for moisture sensitivity testing. The devices can safely withstand a maximum of three reflow passes at these conditions.

Note that although the X/7343-43 case size can withstand wave soldering, the tall profile (4.3 mm maximum) dictates care in wave process development.

Hand soldering should be performed with care due to the difficulty in process control. If performed, care should be taken to avoid contact of the soldering iron to the molded case. The iron should be used to heat the solder pad, applying solder between the pad and the termination, until reflow occurs. Once reflow occurs, the iron should be removed immediately. "Wiping" the edges of a chip and heating the top surface is not recommended.

During typical reflow operations, a slight darkening of the gold-colored epoxy may be observed. This slight darkening is normal and is not harmful to the product. Marking permanency is not affected by this change.

| Profile Feature | SnPb Assembly | Pb-Free Assembly |
|---|-------------------|-------------------|
| Preheat/Soak | | |
| Temperature Min (T_{Smin}) | 100°C | 150°C |
| Temperature Max (T_{Smax}) | 150°C | 200°C |
| Time (t_s) from T_{Smin} to T_{Smax} | 60–120 sec | 60–120 sec |
| Ramp-up Rate (T_L to T_p) | 3°C/sec max | 3°C/sec max |
| Liquidous Temperature (T_L) | 183°C | 217°C |
| Time Above Liquidous (t_L) | 60–150 sec | 60–150 sec |
| Peak Temperature (T_p) | 220°C* 235°C** | 250°C* 260°C** |
| Time within 5°C of Max Peak Temperature (t_p) | 20 sec max | 30 sec max |
| Ramp-down Rate (T_p to T_L) | 6°C/sec max | 6°C/sec max |
| Time 25°C to Peak Temperature | 6 minutes max | 8 minutes max |

Note: All temperatures refer to the center of the package, measured on the package body surface that is facing up during assembly reflow.

*Case Size D, E, P, Y and X

**Case Size A, B, C, H, I, K, M, R, S, T, U, V, W and Z

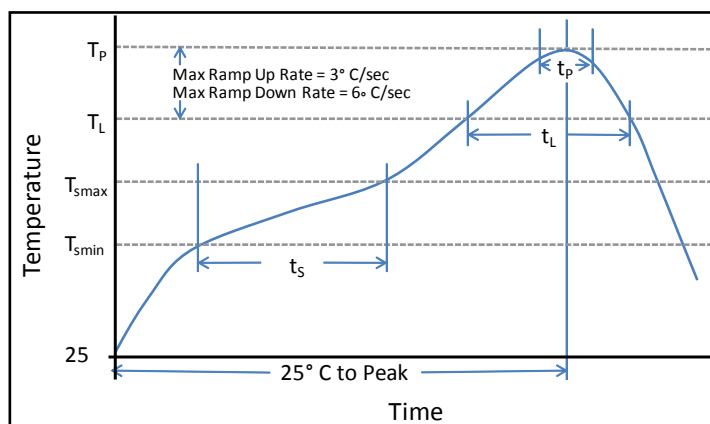

Construction

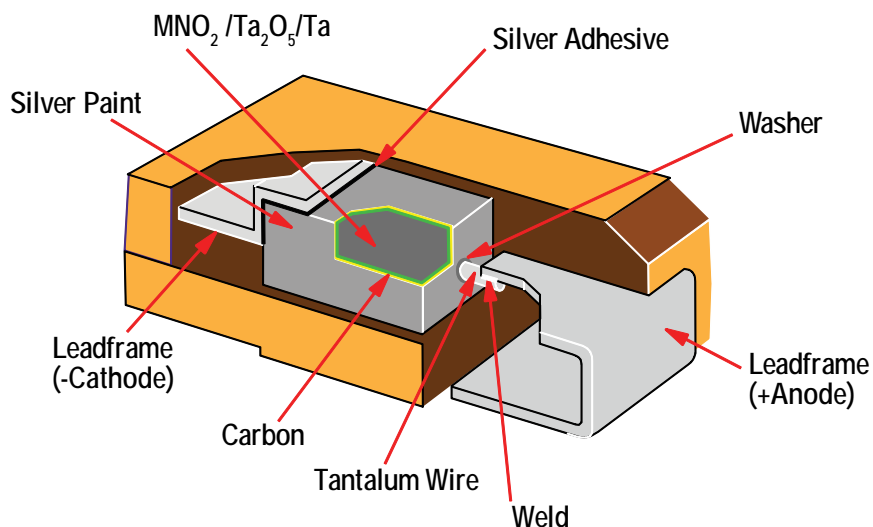

Capacitor Marking

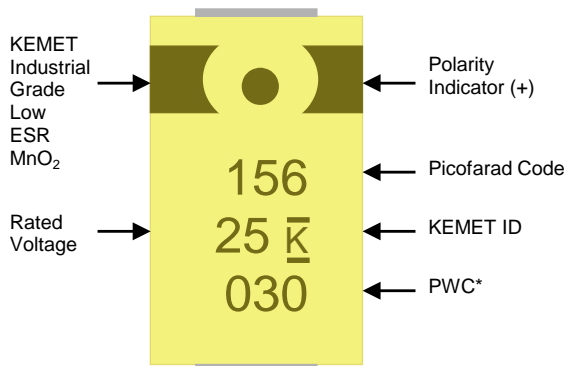

* 030 = 30th week of 2010

Storage

Tantalum chip capacitors should be stored in normal working environments. While the chips themselves are quite robust in other environments, solderability will be degraded by exposure to high temperatures, high humidity, corrosive atmospheres, and long term storage. In addition, packaging materials will be degraded by high temperature - reels may soften or warp, and tape peel force may increase. KEMET recommends that maximum storage temperature not exceed 40°C, and maximum storage humidity not exceed 60% relative humidity. In addition, temperature fluctuations should be minimized to avoid condensation on the parts, and atmospheres should be free of chlorine and sulphur bearing compounds. For optimized solderability, chip stock should be used promptly, preferably within three years of receipt.

Tape & Reel Packaging Information

KEMET's Molded Tantalum and Aluminum Chip Capacitor families are packaged in 8 mm and 12 mm plastic tape on 7" and 13" reels, in accordance with EIA Standard 481-1: Taping of Surface Mount Components for Automatic Handling. This packaging system is compatible with all tape fed automatic pick and place systems.

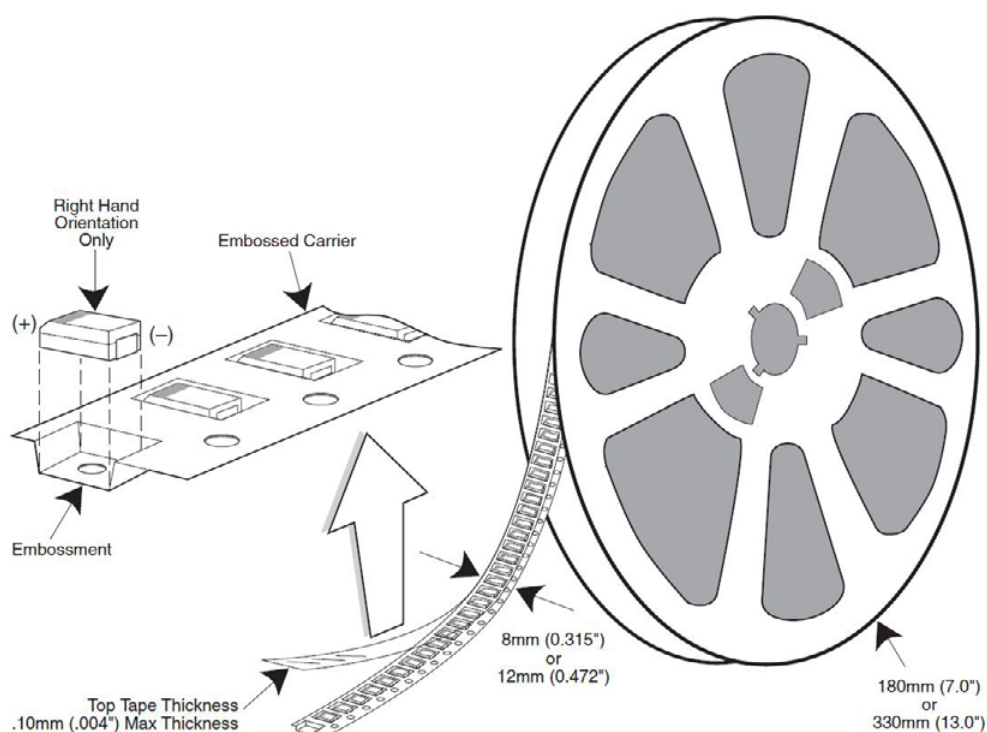

Table 3 – Packaging Quantity

| Case Code | | Tape Width-mm | 7" Reel* | 13" Reel* |
|-----------|---------|---------------|----------|-----------|
| KEMET | EIA | | | |
| R | 2012-12 | 8 | 2,500 | 10,000 |
| I | 3216-10 | 8 | 3,000 | 12,000 |
| S | 3216-12 | 8 | 2,500 | 10,000 |
| T | 3528-12 | 8 | 2,500 | 10,000 |
| M | 3528-15 | 8 | 2,000 | 8,000 |
| U | 6032-15 | 12 | 1,000 | 5,000 |
| L | 6032-19 | 12 | 1,000 | 5,000 |
| W | 7343-15 | 12 | 1,000 | 3,000 |
| Z | 7343-17 | 12 | 1,000 | 3,000 |
| V | 7343-20 | 12 | 1,000 | 3,000 |
| A | 3216-18 | 8 | 2,000 | 9,000 |
| B | 3528-21 | 8 | 2,000 | 8,000 |
| C | 6032-28 | 12 | 500 | 3,000 |
| D | 7343-31 | 12 | 500 | 2,500 |
| Y | 7343-40 | 12 | 500 | 2,000 |
| X | 7343-43 | 12 | 500 | 2,000 |
| E | 7260-38 | 12 | 500 | 2,000 |

* No c-spec required for 7" reel packaging. C-7280 required for 13" reel packaging.

Figure 1 – Embossed (Plastic) Carrier Tape Dimensions

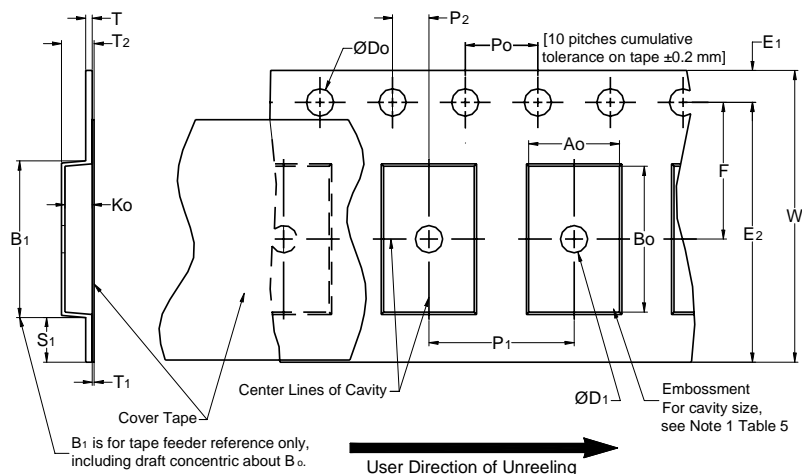

Table 4 – Embossed (Plastic) Carrier Tape Dimensions

Metric will govern

| Constant Dimensions — Millimeters (Inches) | | | | | | | | | |
|--|---------------------------------------|-------------------------------|--------------------------------|-------------------------------|-------------------------------|--------------------|-------------------------------|--|---------------------|
| Tape Size | D ₀ | D ₁ Min. Note 1 | E ₁ | P ₀ | P ₂ | R Ref. Note 2 | S ₁ Min. Note 3 | T Max. | T ₁ Max. |
| 8mm | 1.5 +0.10/-0.0 (0.059 +0.004/-0.0) | 1.0 (0.039) | 1.75 ± 0.10 (0.069 ± 0.004) | 4.0 ± 0.10 (0.157 ± 0.004) | 2.0 ± 0.05 (0.079 ± 0.002) | 25.0 (0.984) | 0.600 (0.024) | 0.600 (0.024) | 0.100 (0.004) |
| 12mm | | 1.5 (0.059) | | | | 30 (1.181) | | | |
| 16mm | | | | | | | | | |
| Variable Dimensions — Millimeters (Inches) | | | | | | | | | |
| Tape Size | Pitch | B ₁ Max. Note 4 | E ₂ Min. | F | P ₁ | T ₂ Max | W Max | A ₀ , B ₀ & K ₀ | |
| 8mm | Single (4mm) | 4.35 (0.171) | 6.25 (0.246) | 3.5 ± 0.05 (0.138 ± 0.002) | 4.0 ± 0.10 (0.157 ± 0.004) | 2.5 (0.098) | 8.3 (0.327) | Note 5 | |
| 12mm | Single (4mm) & Double (8mm) | 8.2 (0.323) | 10.25 (0.404) | 5.5 ± 0.05 (0.217 ± 0.002) | 8.0 ± 0.10 (0.315 ± 0.004) | 4.6 (0.181) | 12.3 (0.484) | | |
| 16mm | Triple (12mm) | 12.1 (0.476) | 14.25 (0.561) | 5.5 ± 0.05 (0.217 ± 0.002) | 8.0 ± 0.10 (0.315 ± 0.004) | 4.6 (0.181) | 16.3 (0.642) | | |

1. The embossment hole location shall be measured from the sprocket hole controlling the location of the embossment. Dimensions of embossment location and hole location shall be applied independent of each other.
2. The tape with or without components shall pass around R without damage (see Figure 5).
3. If S₁ < 1.0 mm, there may not be enough area for cover tape to be properly applied (see EIA Document 481 paragraph 4.3 (b)).
4. B₁ dimension is a reference dimension for tape feeder clearance only.
5. The cavity defined by A₀, B₀ and K₀ shall surround the component with sufficient clearance that:
 - (a) the component does not protrude above the top surface of the carrier tape.
 - (b) the component can be removed from the cavity in a vertical direction without mechanical restriction, after the top cover tape has been removed.
 - (c) rotation of the component is limited to 20° maximum for 8 and 12mm tapes and 10° maximum for 16mm tapes (see Figure 3).
 - (d) lateral movement of the component is restricted to 0.5 mm maximum for 8mm and 12mm wide tape and to 1.0mm maximum for 16mm tape (see Figure 4).
 - (e) see Addendum in EIA Document 481 for standards relating to more precise taping requirements.

Packaging Information Performance Notes

1. **Cover Tape Break Force:** 1.0 Kg minimum.
2. **Cover Tape Peel Strength:** The total peel strength of the cover tape from the carrier tape shall be:

| Tape Width | Peel Strength |
|-------------|--|
| 8mm | 0.1 Newton to 1.0 Newton (10gf to 100gf) |
| 12mm & 16mm | 0.1 Newton to 1.3 Newton (10gf to 130gf) |

The direction of the pull shall be opposite the direction of the carrier tape travel. The pull angle of the carrier tape shall be 165° to 180° from the plane of the carrier tape. During peeling, the carrier and/or cover tape shall be pulled at a velocity of 300±10 mm/minute.

3. **Labeling:** Bar code labeling (standard or custom) shall be on the side of the reel opposite the sprocket holes. Refer to EIA-556 and EIA-624.

Figure 2 – Maximum Component Rotation

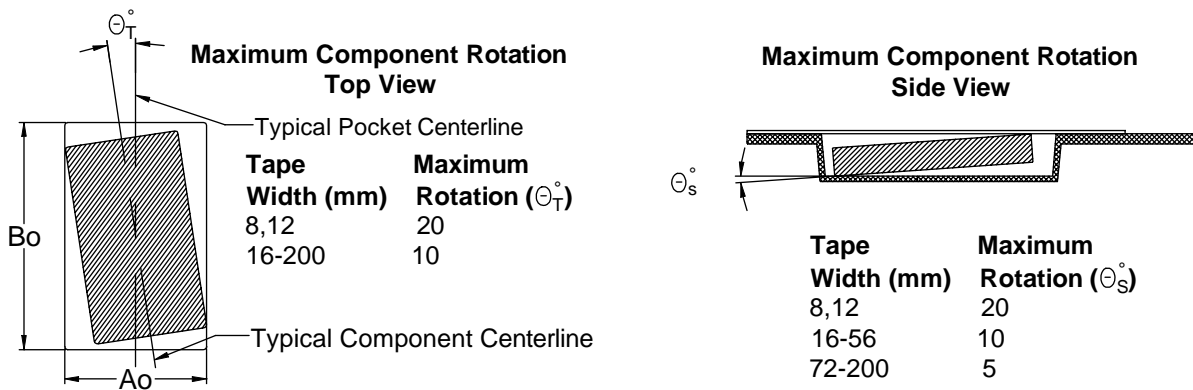

Figure 3 – Maximum Lateral Movement

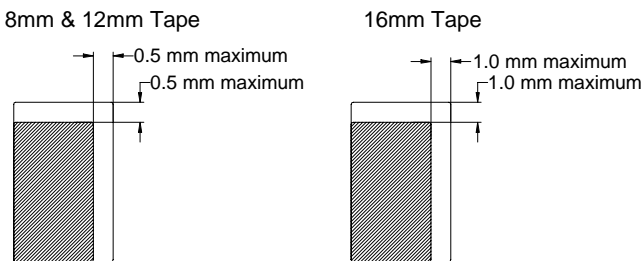

Figure 4 – Bending Radius

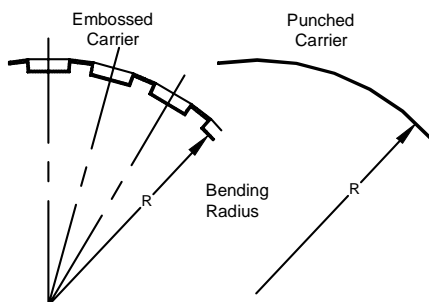
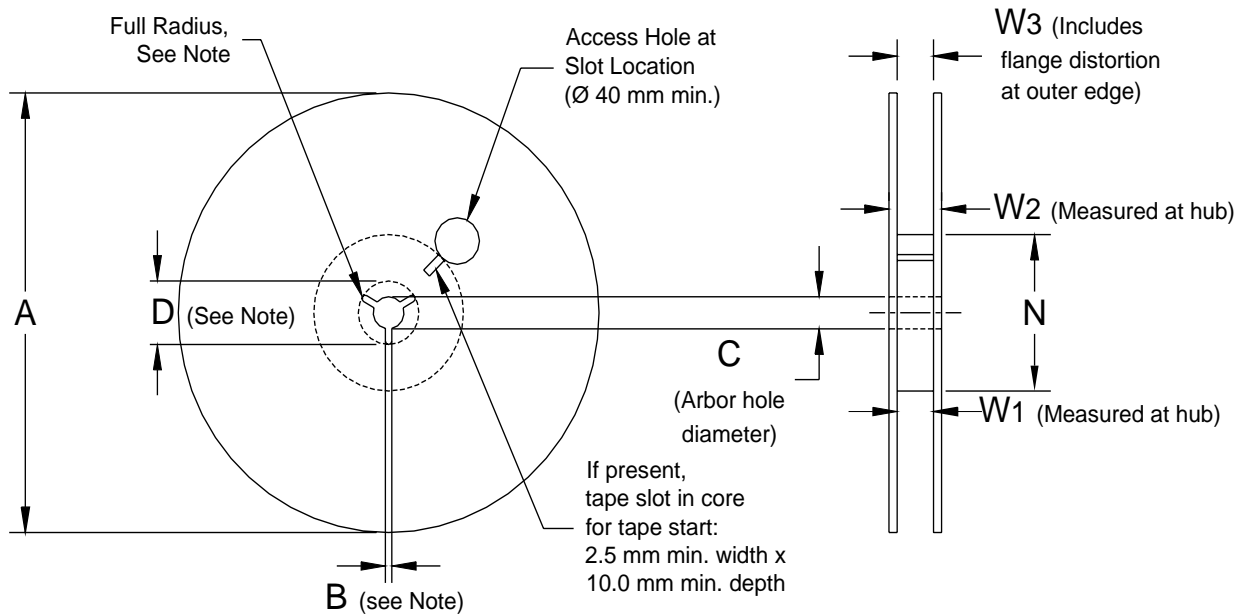

Figure 5 – Reel Dimensions



Note: Drive spokes optional; if used, dimensions B and D shall apply.

Table 5 – Reel Dimensions

Metric will govern

| Constant Dimensions — Millimeters (Inches) | | | | |
|--|--------------------------------|---------------------------------------|--|---|
| Tape Size | A | B Min | C | D Min |
| 8mm | 178 ± 0.20 (7.008 ± 0.008) | 1.5 (0.059) | 13.0 +0.5/-0.2 (0.521 +0.02/-0.008) | 20.2 (0.795) |
| 12mm | or | | | |
| 16mm | 330 ± 0.20 (13.000 ± 0.008) | | | |
| Variable Dimensions — Millimeters (Inches) | | | | |
| Tape Size | N Min | W ₁ | W ₂ Max | W ₃ |
| 8mm | 50 (1.969) | 8.4 +1.5/-0.0 (0.331 +0.059/-0.0) | 14.4 (0.567) | Shall accommodate tape width without interference |
| 12mm | | 12.4 +2.0/-0.0 (0.488 +0.078/-0.0) | 18.4 (0.724) | |
| 16mm | | 16.4 +2.0/-0.0 (0.646 +0.078/-0.0) | 22.4 (0.882) | |

Figure 6 – Tape Leader & Trailer Dimensions

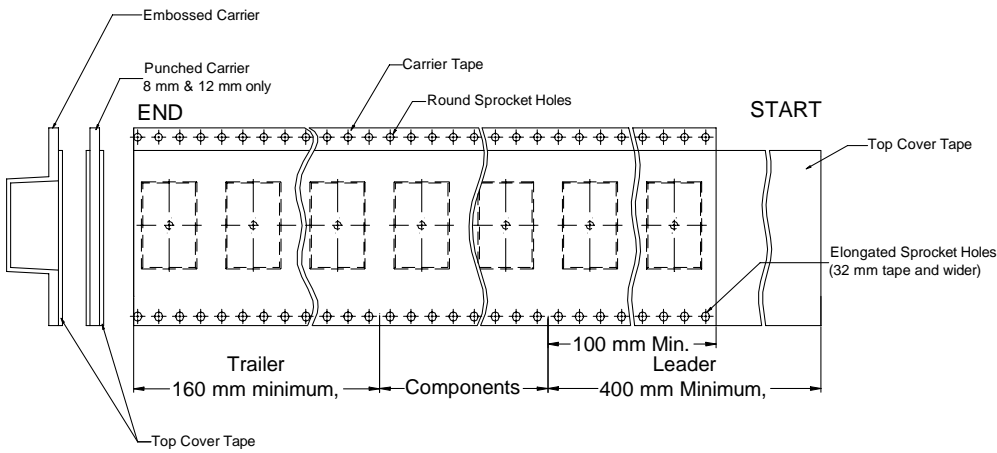
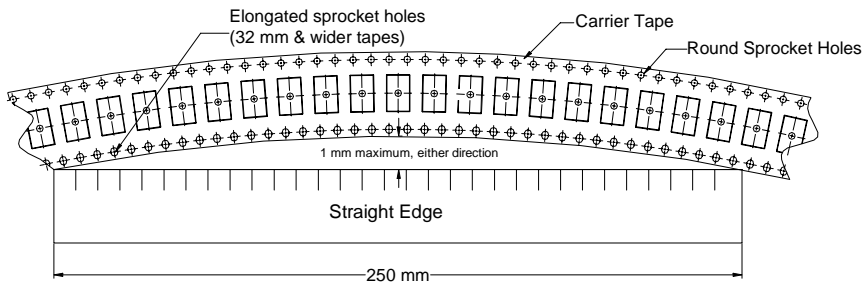

Figure 7 – Maximum Camber



KEMET Corporation World Headquarters

2835 KEMET Way
Simpsonville, SC 29681

Mailing Address:
P.O. Box 5928
Greenville, SC 29606

www.kemet.com
Tel: 864-963-6300
Fax: 864-963-6521

Corporate Offices

Fort Lauderdale, FL
Tel: 954-766-2800

North America

Southeast

Lake Mary, FL
Tel: 407-855-8886

Northeast

Wilmington, MA
Tel: 978-658-1663

West Chester, PA
Tel: 610-692-4642

Central

Schaumburg, IL
Tel: 847-882-3590

Carmel, IN
Tel: 317-706-6742

West

Milpitas, CA
Tel: 408-433-9950

Mexico

Zapopan, Jalisco
Tel: 52-33-3123-2141

Europe

Southern Europe

Geneva, Switzerland
Tel: 41-22-715-0100

Paris, France
Tel: 33-1-4646-1009

Sasso Marconi, Italy
Tel: 39-051-939111

Milan, Italy
Tel: 39-02-57518176

Rome, Italy
Tel: 39-06-23231718

Madrid, Spain
Tel: 34-91-804-4303

Central Europe

Landsberg, Germany
Tel: 49-8191-3350800

Dortmund, Germany
Tel: 49-2307-3619672

Kwidzyn, Poland
Tel: 48-55-279-7025

Northern Europe

Bishop's Stortford, United Kingdom
Tel: 44-1279-757201

Weymouth, United Kingdom
Tel: 44-1305-830747

Coatbridge, Scotland
Tel: 44-1236-434455

Färjestaden, Sweden
Tel: 46-485-563934

Espoo, Finland
Tel: 358-9-5406-5000

Asia

Northeast Asia

Hong Kong
Tel: 852-2305-1168

Shenzhen, China
Tel: 86-755-2518-1306

Beijing, China
Tel: 86-10-5829-1711

Shanghai, China
Tel: 86-21-6447-0707

Taipei, Taiwan
Tel: 886-2-27528585

Southeast Asia

Singapore
Tel: 65-6586-1900

Penang, Malaysia
Tel: 60-4-6430200

Bangalore, India
Tel: 91-806-53-76817

Note: KEMET reserves the right to modify minor details of internal and external construction at any time in the interest of product improvement. KEMET does not assume any responsibility for infringement that might result from the use of KEMET Capacitors in potential circuit designs. KEMET is a registered trademark of KEMET Electronics Corporation.

Other KEMET Resources

| Tools | |
|--------------------------------|---|
| Resource | Location |
| Configure A Part: CapEdge | http://capacitoredge.kemet.com |
| SPICE & FIT Software | http://www.kemet.com/spice |
| Search Our FAQs: KnowledgeEdge | http://www.kemet.com/keask |

| Product Information | |
|--|---|
| Resource | Location |
| Products | http://www.kemet.com/products |
| Technical Resources (Including Soldering Techniques) | http://www.kemet.com/technicalpapers |
| RoHS Statement | http://www.kemet.com/rohs |
| Quality Documents | http://www.kemet.com/qualitydocuments |

| Product Request | |
|-------------------------|---|
| Resource | Location |
| Sample Request | http://www.kemet.com/sample |
| Engineering Kit Request | http://www.kemet.com/kits |

| Contact | |
|--------------------|---|
| Resource | Location |
| Website | www.kemet.com |
| Contact Us | http://www.kemet.com/contact |
| Investor Relations | http://www.kemet.com/ir |
| Call Us | 1-877-MyKEMET |
| Twitter | http://twitter.com/kemetcapacitors |

Disclaimer

All product specifications, statements, information and data (collectively, the "Information") are subject to change without notice.

All Information given herein is believed to be accurate and reliable, but is presented without guarantee, warranty, or responsibility of any kind, expressed or implied.

Statements of suitability for certain applications are based on our knowledge of typical operating conditions for such applications, but are not intended to constitute – and we specifically disclaim – any warranty concerning suitability for a specific customer application or use. This Information is intended for use only by customers who have the requisite experience and capability to determine the correct products for their application. Any technical advice inferred from this Information or otherwise provided by us with reference to the use of our products is given gratis, and we assume no obligation or liability for the advice given or results obtained.

Although we design and manufacture our products to the most stringent quality and safety standards, given the current state of the art, isolated component failures may still occur. Accordingly, customer applications which require a high degree of reliability or safety should employ suitable designs or other safeguards (such as installation of protective circuitry or redundancies) in order to ensure that the failure of an electrical component does not result in a risk of personal injury or property damage.

Although all product-related warnings, cautions and notes must be observed, the customer should not assume that all safety measures are indicated or that other measures may not be required.

