

MOLDED 9 VOLT BATTERY HOLDERS



1294



1295

SPECIFICATIONS

Body: Molded from high impact, Glass Filled Nylon
Terminals: Brass, Tin Plate
Contacts: Steel, Nickel Plate

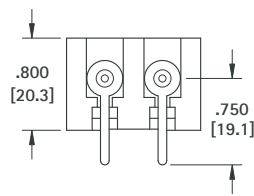
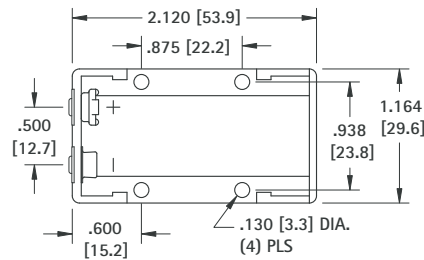

CAT. NO. 1294

PC Terminals

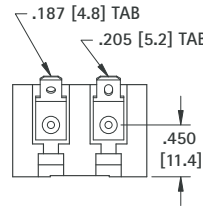

CAT. NO. 1295

Quick-Fit Terminals

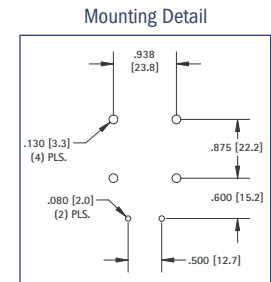

Holds any size, any shape, standard 9 Volt battery. Eliminates need to specify an exact battery brand, size or shape. Ideal for power source or memory back-up use in PLC, telecommunications, data processing, security systems, clocks, radios, toys and appliances.

- Male-female snap-in terminals assure positive contact and proper polarity
- Durable, rugged construction
- Excellent spring retention – holds battery in place
- Withstands severe shock and vibration
- Operating temperature range: -40°F to +266°F (-40°C to +130°C)
- Impervious to most industrial solvents

ALUMINUM 9 VOLT BATTERY HOLDERS

For use with standard 9 Volt battery. Battery snaps in place to insure positive contact. Ideal where severe shock and vibration are encountered. Available with standard solder lugs or printed circuit lugs.

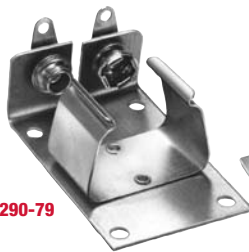

1290-79

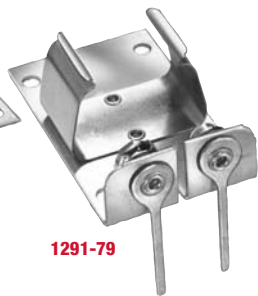

1291-79

SPECIFICATIONS

Frame: Aluminum
Solder Terminals: Brass, Tin Plate
PC Terminals: Brass, Tin Plate
Contacts & Clips: Steel, Nickel Plate
Insulation: Resin Impregnated
Polarizing Washer: Polyethylene

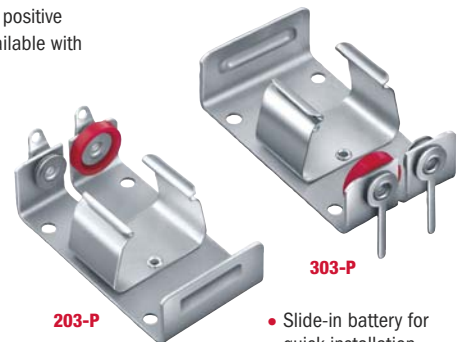

203-P

303-P

- Slide-in battery for quick installation and replacement
- Polarity clearly marked

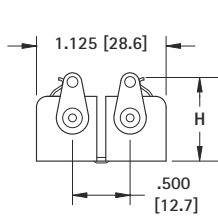
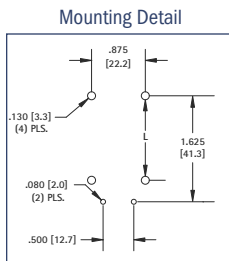
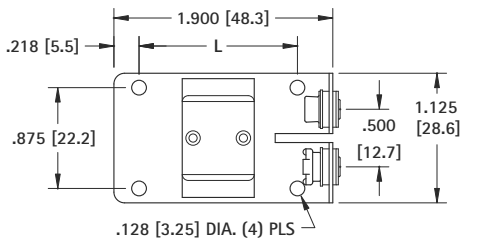

1290

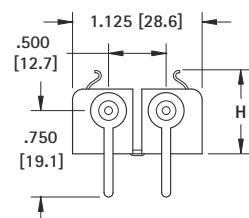

1291

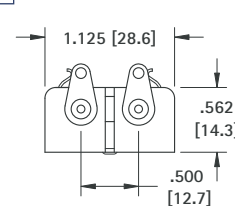
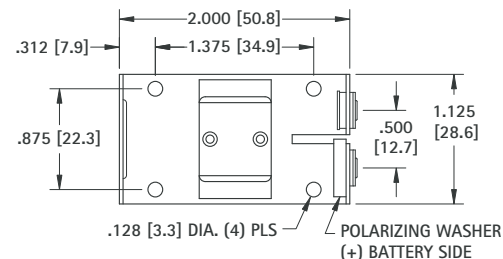

CAT. NO. 203-P

Solder Terminals

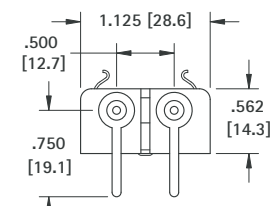

CAT. NO. 303-P

PC Terminals

CAT. NO.	CAT. NO.	H	L	BATTERY REFERENCE	DESCRIPTION
1291	1290	.718 (18.2)	1.375 (34.9)	Alkaline	Low Profile
1291-79	1290-79	.812 (20.6)	1.375 (34.9)	Alkaline	Snap Fit
1291-66	1290-66	.857 (21.8)	1.250 (31.8)	Lithium-Ion	Snap Fit