



Designers' Choice

9 VOLT STRAPS & CONNECTORS

SHIELDED 9 VOLT BATTERY STRAPS

- Insulates and shields 9 Volt battery snap-on connector contacts
- Assures safe secure use, reduces the potential of short circuits and prevents tampering with battery contacts
- Protects circuits, prevents unwanted electrical discharge due to unintended grounding
- Protects battery contacts from dust, dirt, and physical damage
- Ideal for rugged applications, made of high impact molded plastic with integral wire lead strain relief



SPECIFICATIONS

Base: Polypropylene
 Male/Female Contacts: Brass, Nickel Plate
 Wires (Red & Black): #26AWG, Tinned, .187 end strip, UL/CSA1007

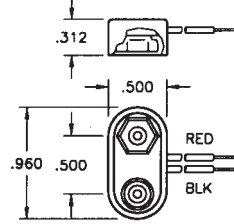
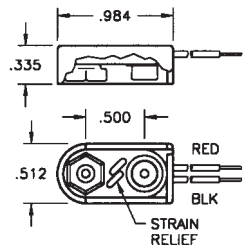

CAT. NO.	*LEAD LENGTH
84-4	4.00
84-6	6.00
84-8	8.00

I-STYLE

CAT. NO.	*LEAD LENGTH
81-4	4.00
81-6	6.00
81-8	8.00

T-STYLE
with Strain Relief

*Tolerance on lead length +/- .250

*Tolerance on lead length +/- .250

PROTECTIVE BATTERY CAP

- Protects 9 Volt batteries and battery packs when they are not in use
- Snap-fits onto battery contacts
- Both male and female contacts are covered, minimizing physical damage which can occur during battery handling, shipping and storage
- Shields the battery contacts and reduces the potential of a short circuit between battery poles
- Protects sensitive electronic equipment, systems and circuits, cap prevents unwanted electrical discharges
- Protects the battery contacts from damage due to dust, dirt and contamination

MATERIAL: Impact Resistant Polypropylene, Black

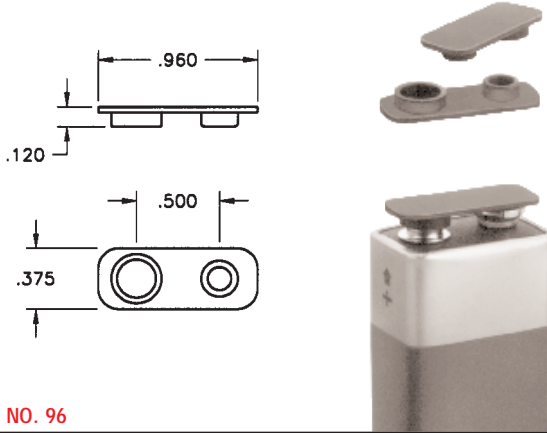

CAT. NO. 96

BATTERY SNAP-ONS (Miniature and Standard)

For most electronic applications requiring a quick connect and disconnect of circuit. Commonly used with 9 Volt or other batteries designed with snap fasteners. Ideal for temporary or permanent means of connecting without soldering. Can be cascaded together for multiple connections.

DIMENSIONS FOR REFERENCE ONLY

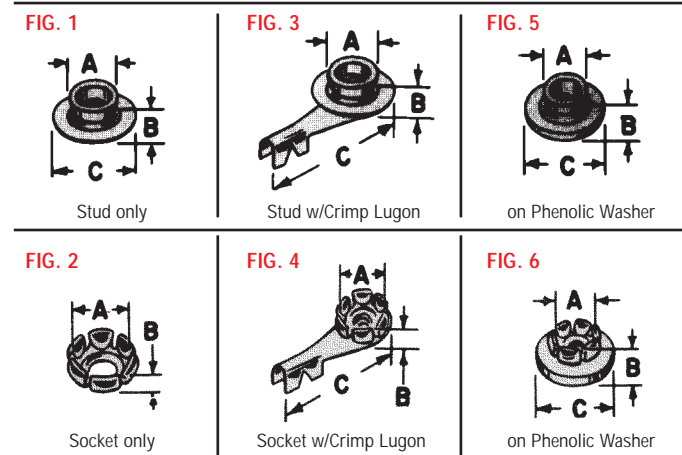

CAT. NO.	FIG. NO.	A	B	C	DESCRIPTION
261	1	.225	.135	.312	Jr. Stud only-.093 hole
262	1	.283	.143	.425	Sr. Stud only-.125 hole
269	2	.205	.156	—	Jr. Socket only-.093 hole
270	2	.265	.156	—	Sr. Socket only-.125 hole
263	3	.225	.170	.790	Jr. Stud w/ Lug
264	3	.283	.185	.840	Sr. Stud w/ Lug
271	4	.205	.200	.790	Jr. Socket w/ Lug
272	4	.265	.185	.835	Sr. Socket w/ Lug
265	5	.225	.205	.500	Jr. Stud on Phenolic Washer
266	6	.205	.205	.500	Jr. Socket on Phenolic Washer
273	5	.283	.200	.500	Sr. Stud on Phenolic Washer
274	6	.265	.225	.500	Sr. Socket on Phenolic

VERTICAL 9 VOLT PC SNAP-ONS

- Space saving, economical
- Excellent mechanical strength
- Low contact resistance
- Durable fibre base
- Wave solderable
- Anti-Wicking Design

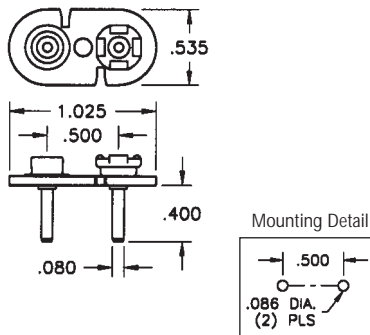
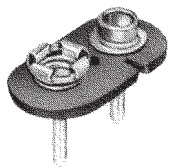

SPECIFICATIONS

Base: .062 Fibre
 Contacts: Steel, Nickel Plate
 Pins: Brass, Tin Plate

CAT. NO. 968 - With PC Pins

- Cost saving design
- Ideal for custom applications
- Attach your own terminals and wire leads

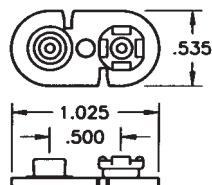

SPECIFICATIONS

Base: .062 Fibre
 Contacts: Steel, Nickel Plate

CAT. NO. 68 - Without PC Pins

9 VOLT BATTERY STRAPS

Designers' Choice



PREMIUM 9 VOLT BATTERY STRAPS

Rigidly constructed. Nickel plate, male and female contacts. Female contacts are spring temper. Accepts numerous insertions to meet U.L. approved standards. Provides excellent mechanical strength and low contact resistance. Wire leads (red and black) are soldered for increased reliability. Wires have tinned copper conductors, PVC insulation and the ends are stripped for easy connection.

Wires are rated to 176°F (80° C) and 300V and meet UL/CSA #1061/#1007 requirements.

Modifications available with different lead lengths.

*Tolerance on lead length +/- .250



Cover Sizes: 1.125 x .530
Contacts: Phos. Br., Nickel Plate
Wire: #26 AWG, 7/34
End Strip: .250 Long, Tinned

VINYL COVER

- FULLY INSULATED
- RIGID ASSEMBLY

I - STYLE

CAT. NO.	*LEAD LENGTH
2238	4.00
2239	6.00
2240	8.00

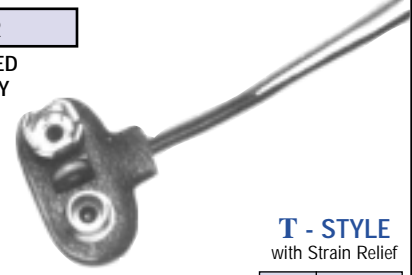

Cover Sizes: 1.000 x .687
Contacts: Phos. Br., Nickel Plate
Wire: #26 AWG, 7/34
End Strip: .250 Long, Tinned

T - STYLE with Strain Relief

CAT. NO.	*LEAD LENGTH
2241	4.00
2242	6.00
2243	8.00



FIBRE BASE

- .062 THICK

Cover Sizes: 1.030 x .535
Contacts: Steel, Nickel Plate
Wire: #22 AWG, 7/30 Prebond
End Strip: .375 Long, Tinned

CAT. NO.	*LEAD LENGTH
68	None
72-4	4.00
72	7.00
72-8	8.00

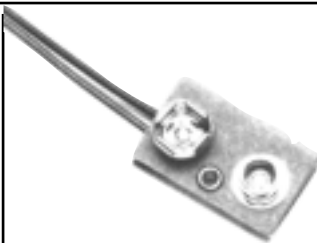

Cover Sizes: .900 x .575
Contacts: Steel, Nickel Plate
Wire: #22 AWG, 7/30 Prebond
End Strip: .375 Long, Tinned

FIBRE COVER

- FULLY INSULATED
- FLEXIBLE ASSEMBLY

I - STYLE

CAT. NO.	*LEAD LENGTH
83-4	4.00
83	6.50
83-8	8.00

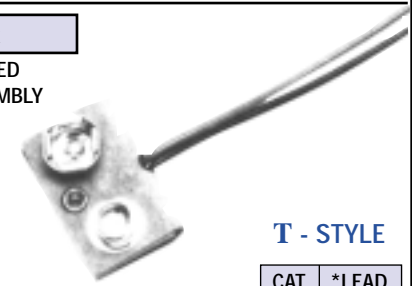

Cover Sizes: .900 x .575
Contacts: Steel, Nickel Plate
Wire: #22 AWG, 7/30 Prebond
End Strip: .375 Long, Tinned

T - STYLE

CAT. NO.	*LEAD LENGTH
85-4	4.00
85-6	6.50
85-8	8.00

ECONOMY 9 VOLT BATTERY STRAPS

When product cost is of the utmost importance these economy battery straps will suit your needs. Brass contacts, nickel plated with vinyl covering. Wires have tinned copper conductors, PVC insulation and the ends are stripped for easy connection. Wires meet UL/CSA #1007 requirements.

Modifications available with different lead lengths.

*Tolerance on lead length +/- .250

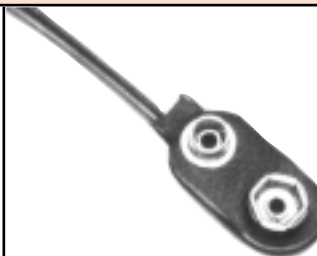

Cover Sizes: 1.125 x .530
Contacts: Brass, Nickel Plate
Wire: #26 AWG, 7/34
End Strip: .250 Long, Tinned

VINYL COVER

- FULLY INSULATED
- RIGID ASSEMBLY

I - STYLE

CAT. NO.	*LEAD LENGTH
232	4.00
233	6.00
234	8.00

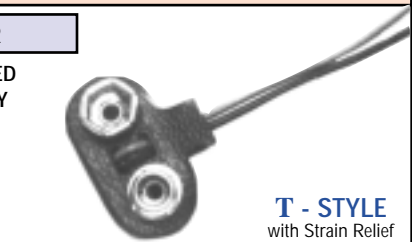

Cover Sizes: 1.000 x .687
Contacts: Brass, Nickel Plate
Wire: #26 AWG, 7/34
End Strip: .250 Long, Tinned

T - STYLE with Strain Relief

CAT. NO.	*LEAD LENGTH
235	4.00
236	6.00
237	8.00

DUAL 9 VOLT BATTERY STRAPS

These dual battery straps are pre-wired for connecting two 9 Volt batteries. Available for either series or parallel connection. Base made from fibre material with steel, nickel plated contacts. Wires have tinned copper conductors, PVC insulation and the ends are stripped for easy connection. Wires meet UL/CSA #1061 requirements.



*Tolerance on lead length +/- .250

PARALLEL

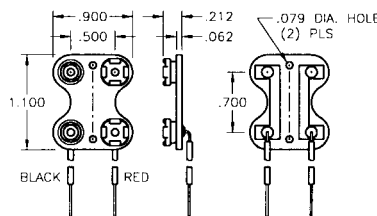

Contacts: Steel, Nickel Plate
Wire: #22 AWG, 7/30 Prebond
End Strip: .375 Long, Tinned

CAT. NO.	*LEAD LENGTH
227	7.00

SERIES

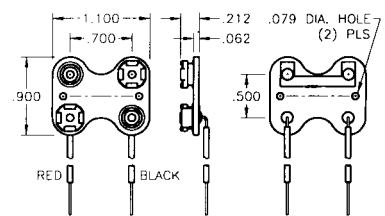

Contacts: Steel, Nickel Plate
Wire: #22 AWG, 7/30 Prebond
End Strip: .375 Long, Tinned

CAT. NO.	*LEAD LENGTH
229	7.00