

SLC

Capacitors

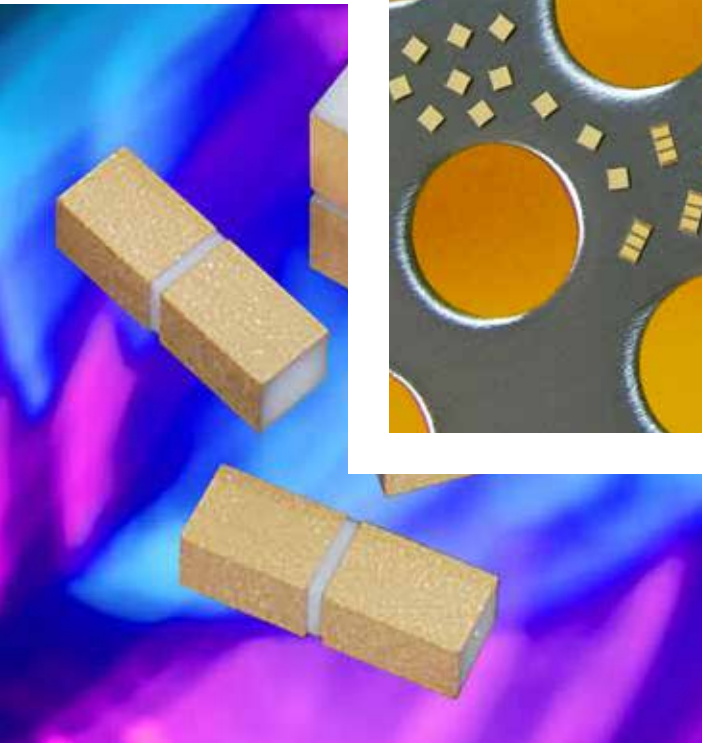

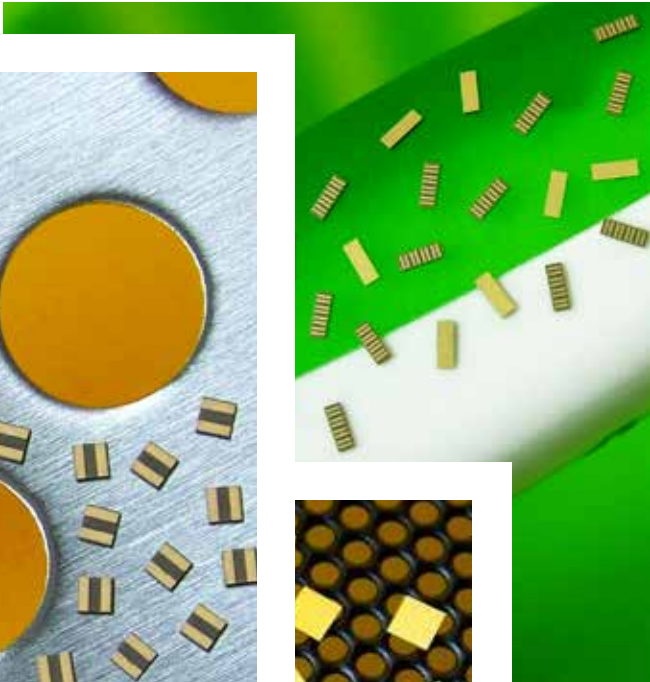



COMPEX • DLI • JOHANSON MFG
NOVACAP • SYFER • VOLTRONICS

Introduction to Knowles Precision Devices

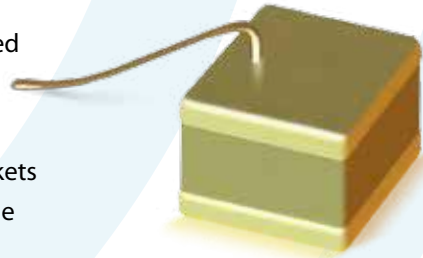
Knowles Precision Devices is a premier global source for Capacitors, RF Filters, EMI Filters, Resonators, non-magnetic components and advanced dielectric materials.

An umbrella for the brands of Compex, DLI, Johanson MFG, Novacap, Syfer and Voltronics, Knowles Precision Devices serves a variety of markets including: military, aerospace/avionics, medical equipment, implantable devices, EMI and connector filtering, oil exploration, instrumentation, industrial electronics, automotive, telecoms and data networks.



						
Capacitors: AEC-Q200					•	
Capacitors: Broadband Blocks		•				
Capacitors: Cap Assemblies				•		
Capacitors: Detonation Pulse				•		
Capacitors: High Power		•			•	•
Capacitors: High Q		•			•	•
Capacitors: High Reliability		•		•	•	
Capacitors: High Temperature				•	•	
Capacitors: High Voltage				•	•	
Capacitors: MLC - Leaded		•		•	•	
Capacitors: MLC - SMD				•	•	
Capacitors: Non-Magnetic		•		•	•	•
Capacitors: Non-Magnetic Trimmers			•			•
Capacitors: Planars and Discoidals					•	
Capacitors: Safety Certified				•	•	
Capacitors: Single Layer	•	•				
Capacitors: Trimmers			•			•
Dielectric Substrates		•				
EMI Filters					•	
Non-Magnetic Hardware						•
Non-Magnetic Inductors			•			
RF: Couplers		•				
RF: Filters		•				
RF: Gain Equalizers		•				
RF: Power Dividers		•				
RF: Resonators		•				
Thin Film: Bias Filter Networks		•				
Thin Film: Build To Print	•	•				
Thin Film: Resistors	•					
Thin Film: Self Bias Networks		•				

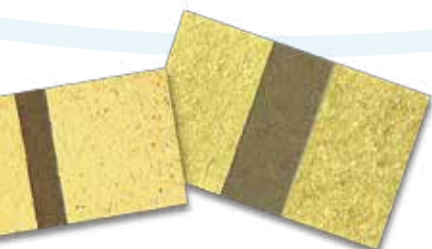

Contents

Introduction	Frequency & Application Chart	DLI	2
<hr/>			
Single Layer Capacitors	SLC - Dielectric Information	DLI	3-4
DLI	General Information (SLC - Specifications)	DLI	5
	Packaging	DLI	6
	V Series	DLI	7-8
	Border Cap	DLI	9-10
	T-Cap®	DLI	11
	Di-Cap®	DLI	12-13
	Bar Cap®	DLI	14-15
	Gap Cap®	DLI	16-18
	Bi-Cap®	DLI	19-20
<hr/>			
Single Layer Capacitors	General Information (Material & metallization).....	Complex	21
Complex	Typical Temperature Characteristics	Complex	22
	CSA Series	Complex	23-24
	CSM Series	Complex	25-26
	CSB Series	Complex	27-28
	CR/CM Series	Complex	29-30
<hr/>			
Substrates & Heatsinks	Thin Film - High-K Ceramic Substrates & Plates	DLI	31
DLI	SLC - Heatsinks, Standoffs & Submounts.....	DLI	32
<hr/>			
Substrates & Heatsinks	SBT Series - Submounts.....	Complex	33
Complex	MST Series - Mounting Shorts	Complex	34
<hr/>			
Broadband Devices	Milli-Cap®	DLI	35-36
DLI	Opti-Cap®	DLI	37-38
	PX Series	DLI	39-40
	Broadband Blocks.....	DLI	41
<hr/>			
RF Components	Gain Equalizers	DLI	42-43
DLI	Miniature RF Blocking Network.....	DLI	44-45
	Self Bias Network	DLI	46
	Bias Filter Network	DLI	47

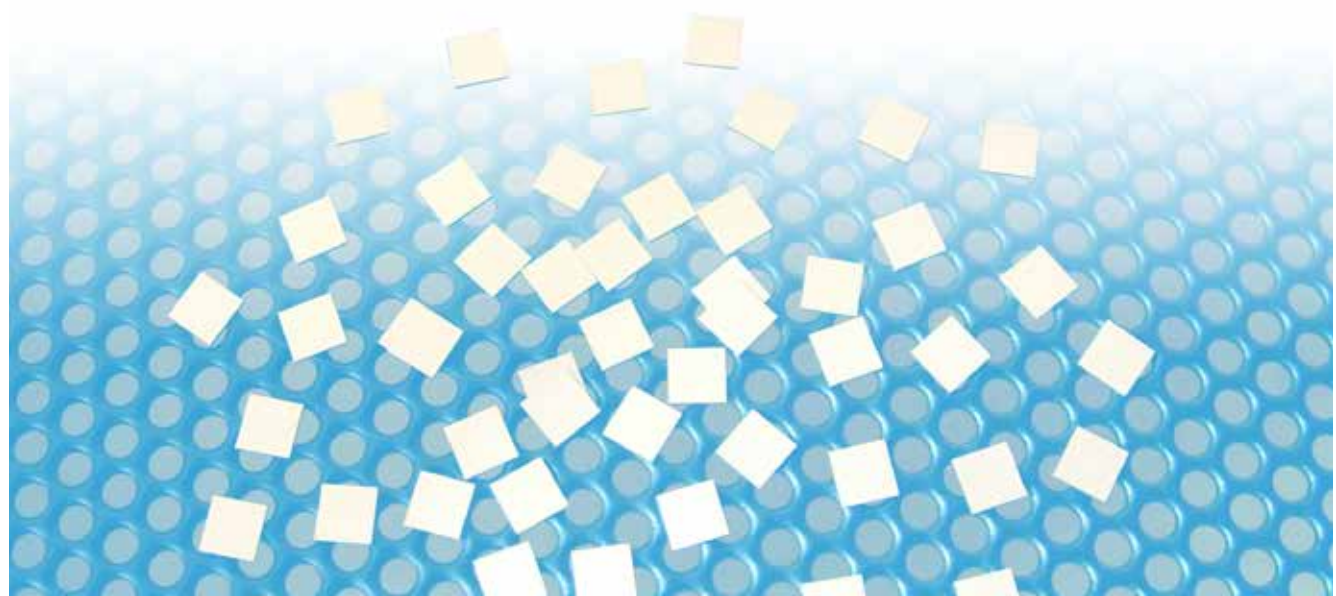

Simplified Frequency & Product Application Chart

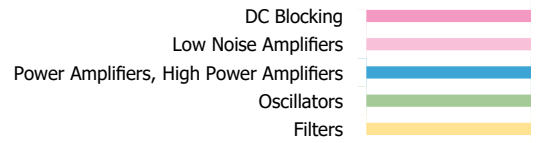

SLC and Thin Film

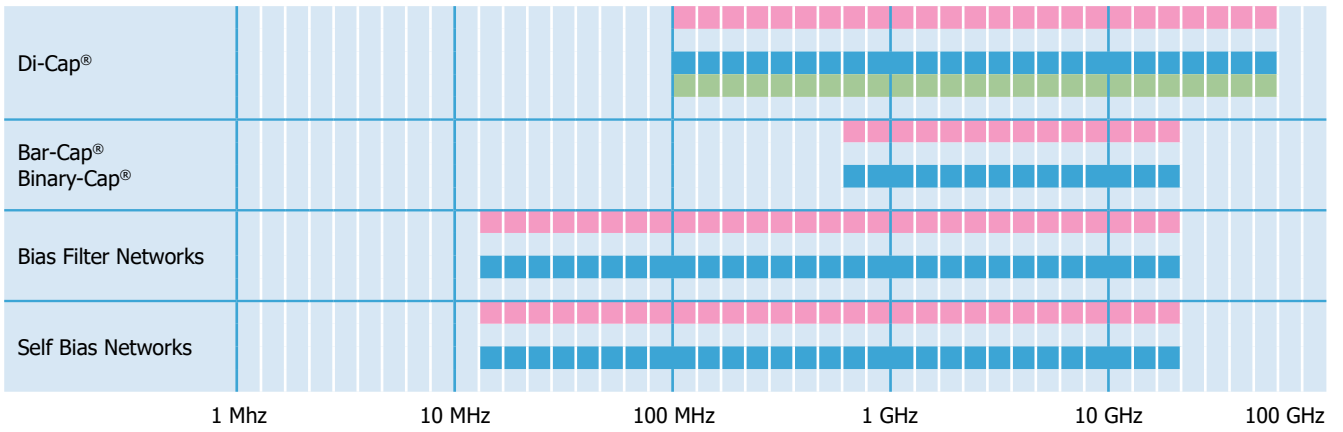

Broadband and DC Blocks

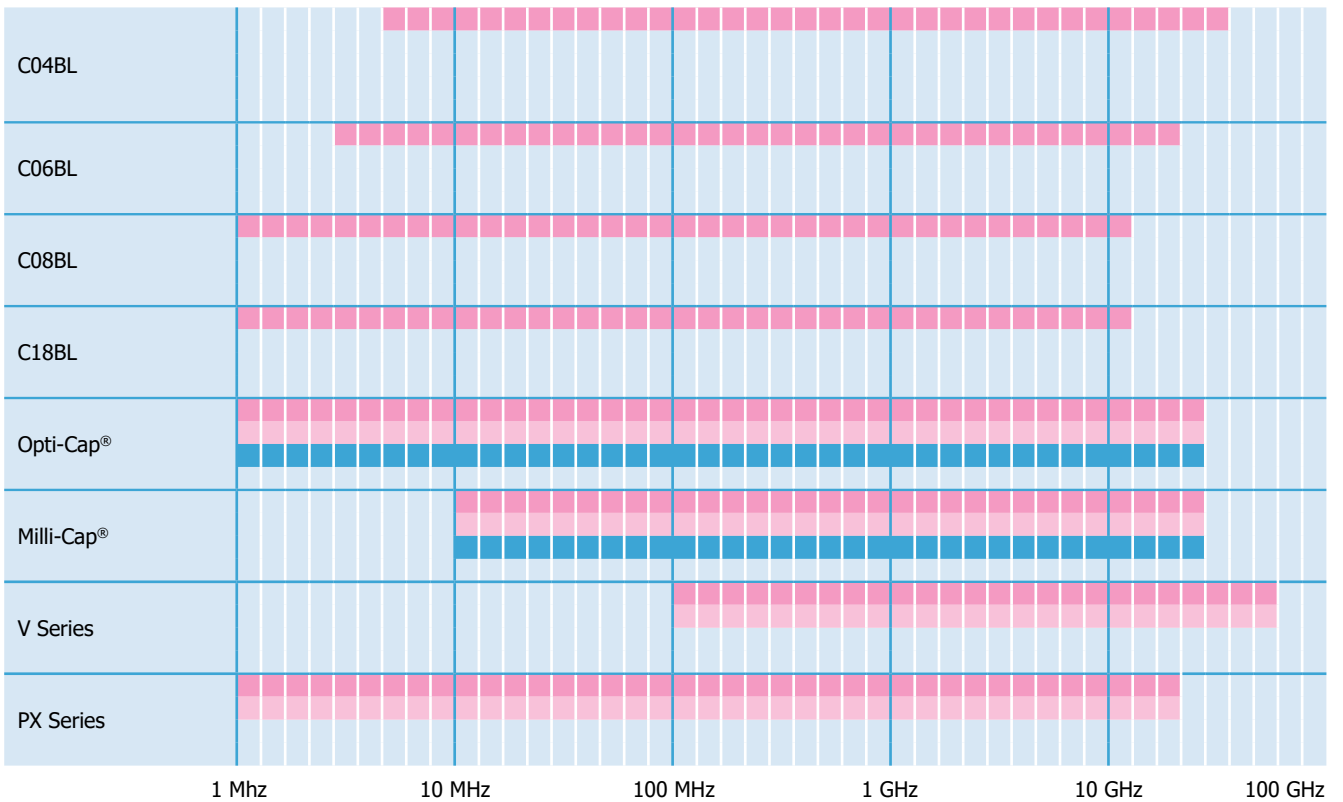

SLC - Dielectric Information

Single Layer Capacitors are available with any of our proprietary dielectric materials in the following configurations:

- Border Cap[®]**
- Di-Cap[®]**
- Bar Cap[®]**
- Bi-Cap[®]**
- Gap Cap[®]**
- T-Cap[®]**

Please consult the following pages for part number identification.

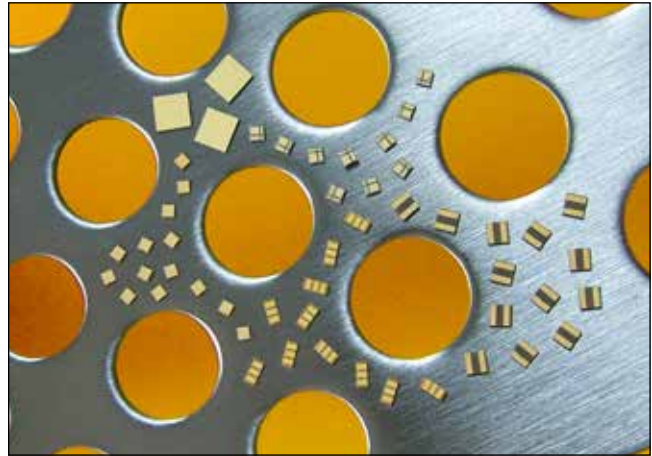

DLI Class I Dielectric Materials

Dielectric Code	Relative ϵ_r @ 1 MHz	Temperature Coefficient -55°C to 125°C (ppm/°C Max)	1 MHz Dissipation Factor (% Maximum)	25°C Insulation Resistance (M Ω)	125°C Insulation Resistance (M Ω)
PI	9.9	P105 \pm 20	0.15	>106	>105
PG	13	P22 \pm 30	0.15	>106	>105
AH	20	P90 \pm 20	0.15	>106	>105
CF	24	0 \pm 15	0.60	>106	>105
NA	22	N30 \pm 15	0.15	>106	>105
CD	37	N20 \pm 15	0.15	>106	>105
NG	43	N220 \pm 60	0.25	>106	>105
CG	70	0 \pm 30	0.70	>106	>105
DB	72	N50 \pm 30	0.15	>106	>105
NP	85	N750 \pm 200	0.50	>104	>103
NR	160	N1500 \pm 500	0.25	>106	>105
NS	300	N2400 \pm 500	0.70	>106	>105
NU	600	N3700 \pm 1000	1.50	>106	>105
NV	900	N4700 \pm 1000	1.20	>106	>105

DLI Class II Dielectric Materials

Dielectric Code	Relative ϵ_r @ 1 MHz	Temperature Coefficient -55°C to 125°C (ppm/°C Max)		1 MHz Dissipation Factor (% Maximum)	25°C Insulation Resistance (M Ω)	125°C Insulation Resistance (M Ω)
		No Bias, Pre Voltage Conditioning	No Bias, Post Voltage Conditioning			
BF*	445	\pm 7.5	\pm 10	2.5	>104	>102
BD	700	\pm 10	\pm 15	2.5	>104	>103
BG*	900	\pm 10	\pm 15	2.5	>104	>103
BC	1300	\pm 10	\pm 15	2.5	>104	>103
BE	1250	\pm 10	\pm 15	2.5	>104	>103
BL	2000	\pm 15	\pm 25	2.5	>105	>104
BJ	3300	\pm 10	\pm 15	3.0	>105	>104
BN	4500	\pm 15	\pm 25	3.0	>105	>104
UX	25,000	\pm 15%	\pm 25%	2.5	>103	>102

DLI Class III Dielectric Materials

BT*	4200	+22, -56% (-55°C to 105°C)	+22, -56% (-55°C to 105°C)	3.0	>105	>102
BU	8500	+22, -82% (10°C to 85°C)	+22, -82% (10°C to 85°C)	3.0	>105	>104
BV	13,500	+22, -82% (10°C to 85°C)	+22, -82% (10°C to 85°C)	3.0	>105	>104

Note: * Recommended for commercial use only. Please contact an inside sales representative for additional information.



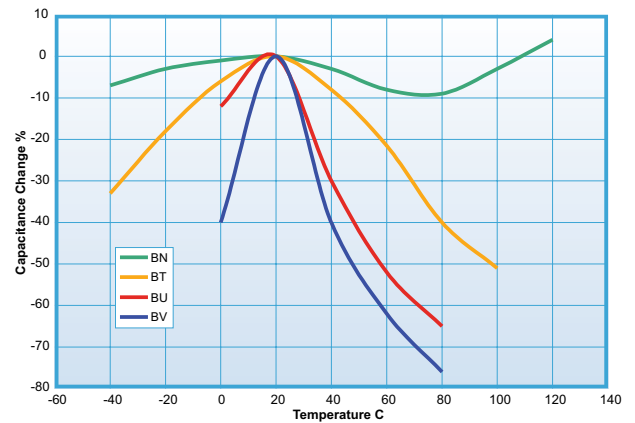
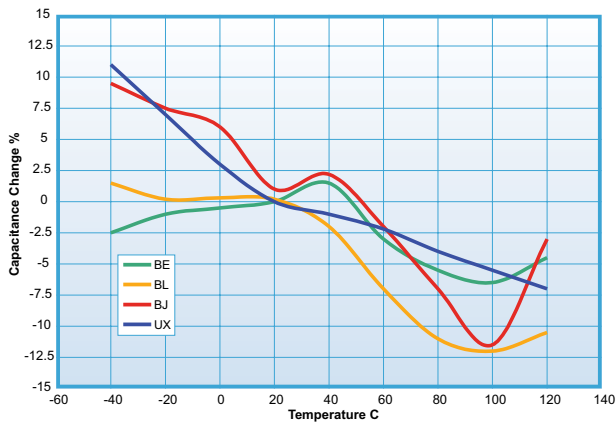
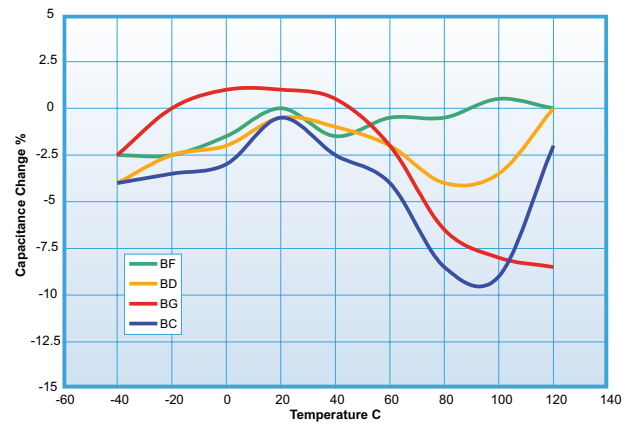
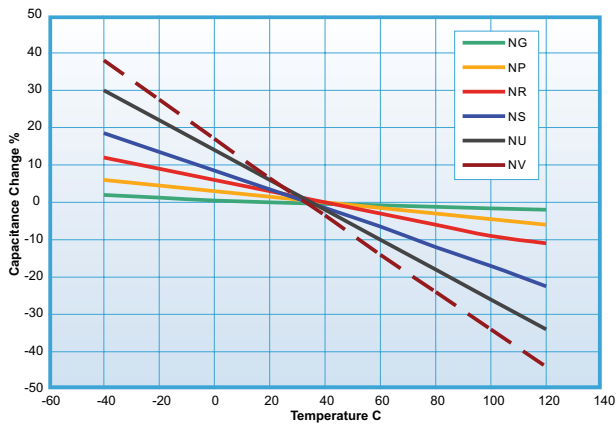
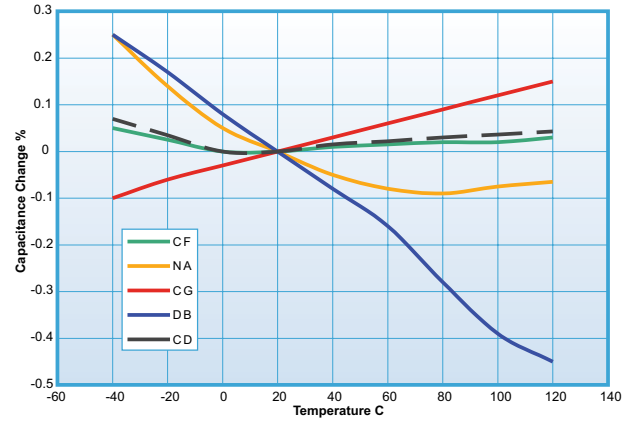
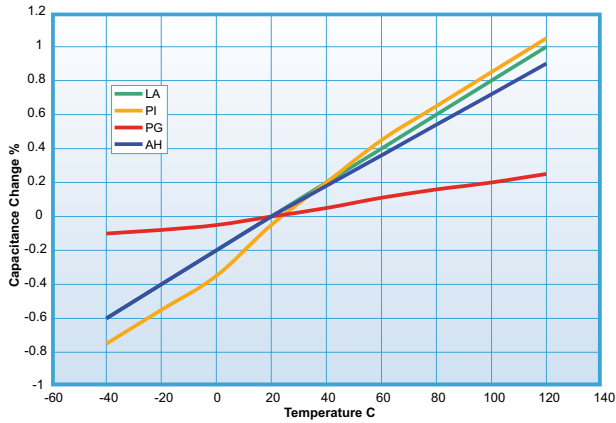

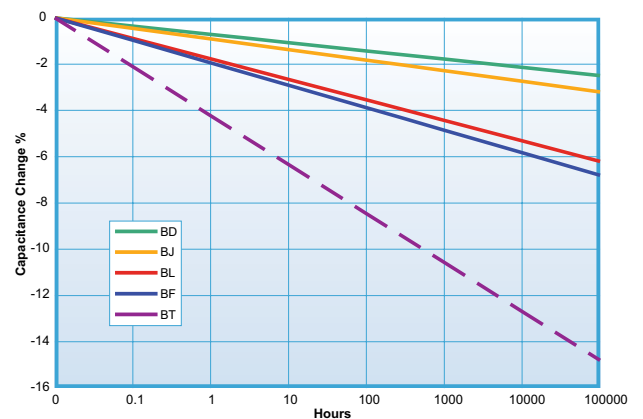
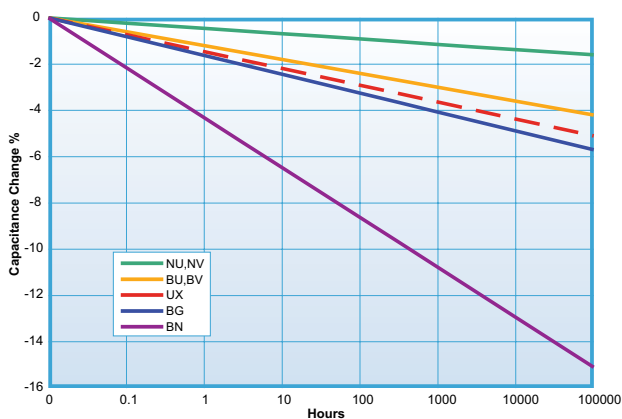

Dielectric Temperature Characteristics



Dielectric Aging Characteristics

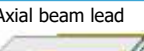

Termination Codes

	Code	Description (Layers in order from dielectric material to outermost)	Capacitor Types	
	P	S1 (Sputter Plated) 1. 300 Angstroms Titanium-Tungsten 2. 50μ Inches min. Nickel-Vanadium 3. 100μ Inches min. Gold	Di-Cap®, T-Cap®, Bar Cap®, Binary Cap® and Gap Cap	
		AU-100 (Wet Plated) 1. 75μ Inches min. Nickel 2. 100μ Inches min. Gold		
		S2 1. 300 Angstroms Titanium-Tungsten 2. 50μ Inches min. Nickel-Vanadium 3. 300μ Inches min. Gold-Tin		
	M	S5 1. 300 Angstroms Titanium-Tungsten 2. 100μ Inches min. Gold	Di-Cap®, T-Cap®, Bar Cap®, Binary Cap® and Gap Cap	
	B	S1	AU-100	Single Border Cap
	E	S1	AU-100	Double Border Cap
Single beam lead	L	Standard lead material is silver (Ag) .002" thick. Optional Gold (Au)		Di-Cap®
Axial beam lead	A	Standard lead material is Silver (Ag) .002" thick. Optional Gold (Au)		Di-Cap®
	Z	Standard lead material is Tin-Copper (Sn,Cu) .002" thick. Optional Gold (Au)		
Standard axial beam lead	S	Standard lead material is silver (Ag) .002" thick. Optional Gold (Au)		Di-Cap®

Test Level Codes

Code	Description
Industrial / Commercial Options	
Y	• 1% AQL 2 Side Visual Screening
X	• 100% 4 Side Visual Screening • 1% AQL for the electrical parameters Capacitance, Dissipation Factor, Insulation Resistance and Dielectric Withstanding Voltage
High Reliability Options	
A	MIL-PRF-49464 Group A • 100% Thermal Shock • 100%, 100 +0/-4 Hours Voltage Conditioning • 100% Electrical Screening • 100% 6 Side Visual Screening • Bond Strength • Die Shear Strength • Temperature Coefficient Limits
B	MIL-PRF-49464 Group B • MIL-PRF-49464, Group A • Immersion • Low Voltage Humidity • Life
D	Special agreed upon testing to customers' formal specification. Customer Drawing Required! (May include, but is not limited to, one or more of the following common requests.) • MIL-PRF-38534 Class H Element Evaluation. • MIL-PRF-38534 Class K Element Evaluation. • 10(0) Destructive Bond Pull per MIL-STD-883, Method 2011. • 10(0) Die Shear per MIL-STD-883, Method 2019. Consult Factory for other alternatives or assistance in specifying custom testing.
E	6 Side Visual Screening per MIL-STD-883, Method 2032.

All Single Layer Capacitors are Lead Free and RoHS compliant.

Capacitance Tolerance Table

Tolerance Code	Tolerance
A	±.05pF
B	±.10pF
C	±.25pF
D	±.50pF
E	±.5%
F	±1%
G	±2%
H	±3%
I	±4%
J	±5%
K	±10%
L	±15%
M	±20%
X	GMV
V	+100%, -0%
Z	+80% ,-20%
S	Special

Environmental & Physical Testing Procedures

Parameter	Method	MIL-STD-202
		Condition
Thermal Shock	107	A, (modified), -55°C to +125°C.
Immersion	104	B
Moisture Resistance	106	-
Resistance to Solder Heat	210	C, 260°C for 20 seconds.
Life	108	A, 96 Hours @ +125°C.
Barometric Pressure	105	B
Shock, (Specified Pulse)	213	I, 100g's, 6ms.
Vibration, High Frequency	204	G, 30g's peak, 10Hz to 2kHz.

Parameter	Method	MIL-STD-202
		Condition
Bond Strength	2011	D, 3 grams minimum with .001" dia wire
Die Shear Strength	2019	Limit per MIL-STD-883, Figure 2019-4.
Temperature Cycling	1010	C
Mechanical Shock	2002	B,Y1,
Constant Acceleration	2001	3,000g's, Y1 direction

SLC - Packaging

SLC Waffle Packaging

DLI offers a wide variety of standard design waffle packs in various materials depending on the application. Typical material offerings are antistatic and gel pack, which can contain up to 400 pieces depending on component dimension. Custom waffle packs are available; please consult the factory for details.

SLC Tape and Reel

DLI offers tape and reel packaging solutions for a variety of our single layer capacitor case sizes. Utilizing the latest technology and equipment to provide our customers the highest quality products, our standard SMD tape and reel packaging meets or exceeds EIA standards. Custom tape and reel packaging available; consult the factory for options.

SLC on Tape Ring

DLI offers single layer capacitors re-populated on blue membrane tape and photon ring assembly to maximize efficiency and minimize product cost. Used in high volume applications, the re-populated capacitors provide for more efficient component placement and fewer "pick and place" machine change outs. The re-populated capacitors meet GMV capacitance value, are 100% visually acceptable and can be re-populated in custom shapes and sizes on a 6 inch photon tape ring.

SLC "Black Dotted" on Tape Ring

DLI offers "black dotted" capacitors on membrane tape and photon ring assembly. For high volume applications utilizing visual recognition, a less expensive alternative is the use of "black dotted" capacitors provided on saw dice membrane tape. The non- "black dotted" capacitors meet GMV capacitance value and a minimum of 75% visually acceptable product is guaranteed.

Storage

Single layer capacitors with applicable terminations will be solderable for a minimum of 1 year from date of shipment if properly stored in their original packaging. For extended periods, storage in a dry nitrogen environment is recommended. Product supplied on membrane tape and photon ring should be stored in the original container and in an environmentally controlled area where temperature and humidity are maintained. It is recommended not to store the product in direct light as this can negatively impact the adhesion properties of the tape.

Handling

Single layer ceramic capacitors should be handled carefully during component transfer or placement, preventing damage to the gold and ceramic surfaces. The capacitors should be handled with precision stainless steel tweezers or a vacuum wand. Contacting the capacitor with bare hands should be avoided as resulting contaminants will affect the performance of the component.

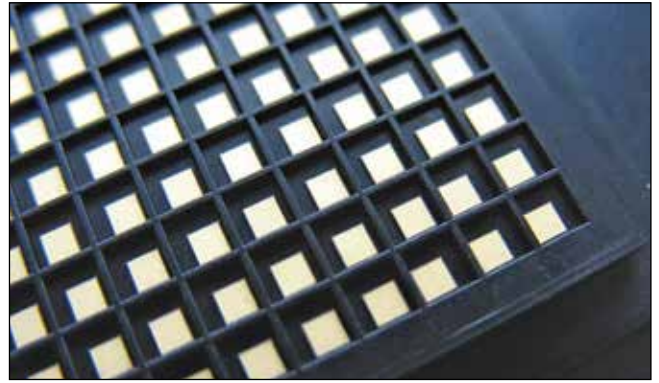

SLC Waffle Packaging

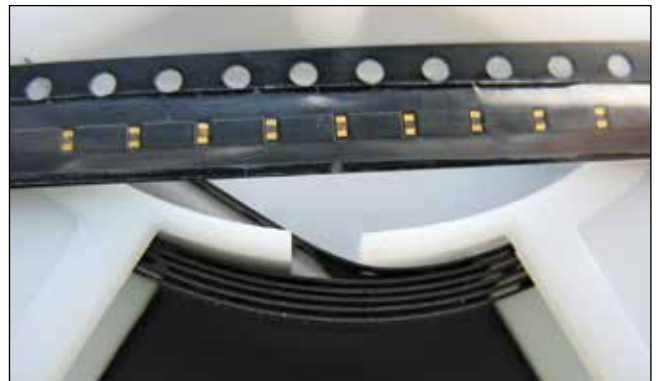

SLC Tape and Reel

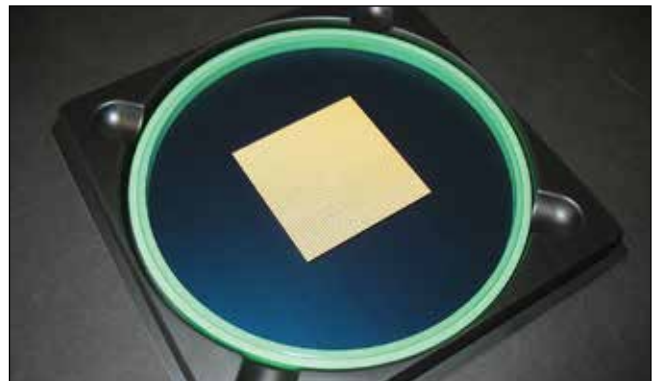

SLC on Tape Ring



Description

Class II dielectric material with X7R characteristics for DC Blocking or RF Bypass applications in a broad frequency range.

These high frequency, wire bondable single layer capacitors are perfect for GaN and GaAs amplifier applications where small size and microwave performance is key to a well performing circuit.

- X7R Temperature Stability
- Excellent high frequency response
- Wire Bondable
- RoHS compliant
- High capacitance in a small footprint
- MSL-1
- Rated Operating/Storage Temp. -55 to +125°C

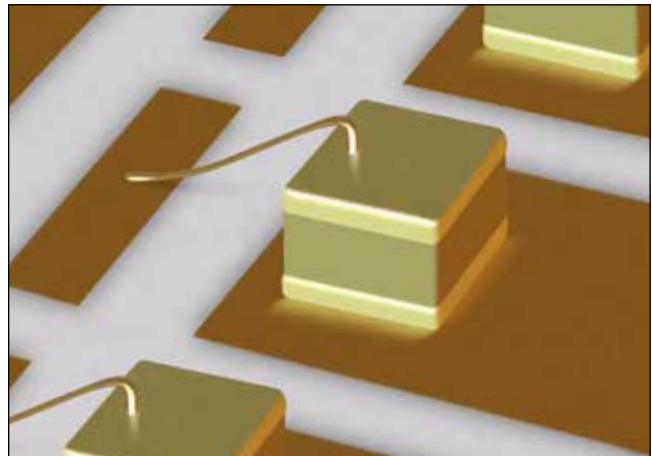

Functional Applications

- DC Blocking
- RF Bypassing
- Filtering
- Tuning and Coupling

Part Number	Capacitance	Voltage	Dissipation Factor @ 1MHz	Insulation Resistance	
				@ +25C	@ +125C
V30BZ102M6SX	1nF ±20%	200WVDC	2.5%	10 ³ MΩ	10 ² MΩ
V30BZ222M8SX	2.2nF ±20%	150WVDC	2.5%	10 ³ MΩ	10 ² MΩ
V30BZ472M1SX	4.7nF ±20%	100WVDC	2.5%	10 ³ MΩ	10 ² MΩ
V30BZ682M1SX	6.8nF ±20%	100WVDC	2.5%	10 ³ MΩ	10 ² MΩ
V30BZ103M1SX	10nF ±20%	100WVDC	2.5%	10 ³ MΩ	10 ² MΩ

Metal thickness is min. 100μ" of Au over min. 50μ" of Ni

Part Number	Dimensions		
	Length	Width	Thickness
V30BZ102M6SX	0.030" ±0.003" (0.762mm ±0.076mm)	0.030" ±0.003" (0.762mm ±0.076mm)	0.022" ±0.003" (0.559mm ±0.0762mm)
V30BZ222M8SX			
V30BZ472M1SX			
V30BZ682M1SX			
V30BZ103M1SX			

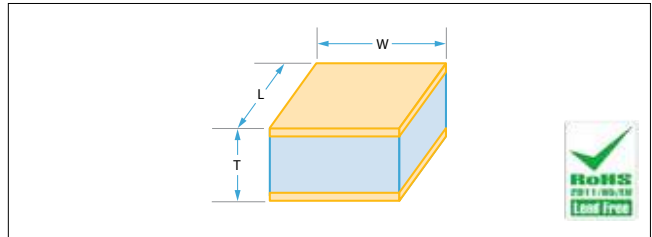

Ordering information - SLC - V Series Capacitors

V	30	BZ	102	M	5	S	X	
Product	Case Size	Material	Capacitance (pF)	Tolerance	Voltage	Termination	Test Level	Packaging
V = V Series	30	See material tables on Page 3.	102 = 1nF 222 = 2.2nF 472 = 4.7nF 682 = 6.8nF 103 = 10nF	M = ±20%	5 = 50V 1 = 100V 6 = 200V 8 = 150V	S = Au / Ni	X = Commercial A = Group A B = Group B See test level definitions on page 5.	Available in Waffle Packs.

Performance Characteristics - V Series Capacitors

DC Blocking

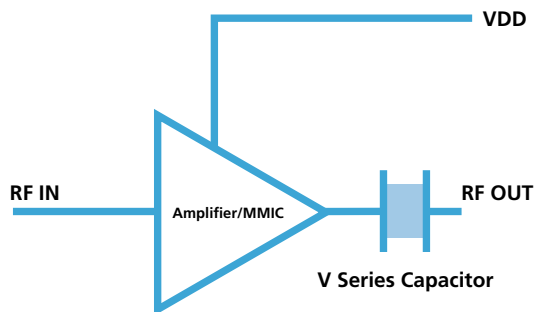

RF Bypassing

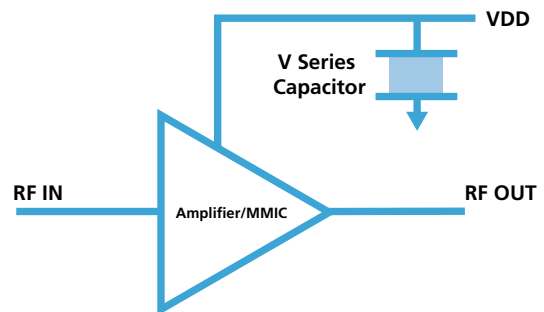

Series data

Typical Insertion Loss (S21)

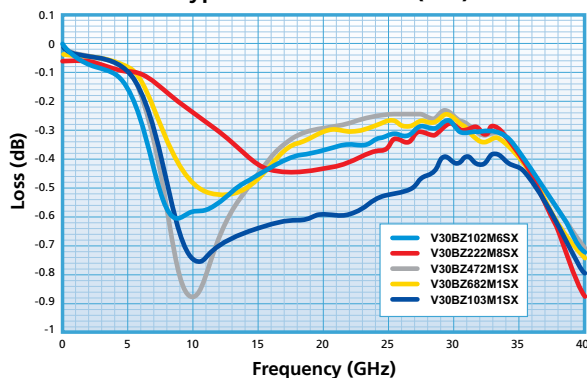

Shunt data

Typical Insertion Loss (S21)

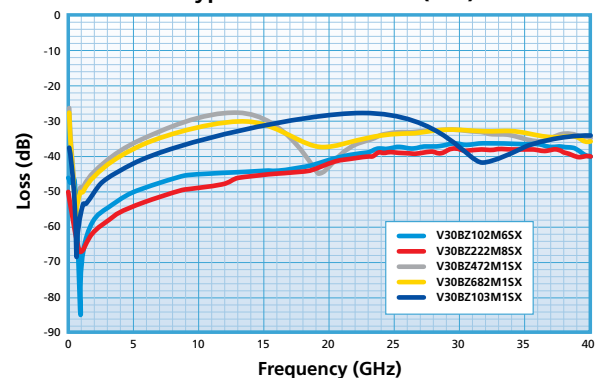

Attachment Method - V Series Capacitors

Recommended Attachment Method (Conductive Epoxy)

Alternative Attachment Method (Gold Eutectic)

Bonding can be done with either needle or automatic dispensers.

Epoxy curing defer to the epoxy manufacturer's preferred schedule but typically in the 125°C to 150°C range.

Benefits of epoxy is easier repairs, cure need not be started immediately so multiple substrates may be processed at one time and epoxy is effective in higher frequencies.



Description

SLC with recessed metallization, available with borders on one or both sides.

Recessed metallization have been designed to minimize the potential of shorting during attachment (epoxy or solder).

- Available from 0.03pF to 2400pF
- Operating frequency up to 100GHz
- Wire Bondable
- 25, 50 and 100 Volt options
- Customized designs are available, please contact sales office

Functional Applications

- DC Blocking
- RF Bypass
- Filtering
- Tuning and Coupling



Test Level Codes

Commercial Level	
Y	1% AQL 2-Side Visual
X	100% 4-Side Visual 1% AQL Electrical (CAP/DF/IR & DWV)

High Reliability

A	MIL-PRF-49464 Group A • 100% Thermal Shock • 100% Voltage Conditioning • 100% Electrical (CAP/DF/IR & DWV) • 100% 6-Side Visual • Bond Strength • Die Shear • Temperature Coefficient	B	MIL-PRF-49464 Group B • MIL-PRF-49464 Group A • Immersion • Low Voltage Humidity • Life
		D	• Customer Defined
		E	• 6-Side Visual

Voltage

Code	Voltage
2	25 Volts
5	50 Volts
1	100 Volts

Tolerance

Code	Description
P	± 0.01pF
A	± 0.05pF
B	± 0.1pF
C	± 0.25pF
D	± 0.50pF
K	± 10%
L	± 15%
M	± 20%
X	GMV (Guarantee Minimum Value)
Z	+80%, -20%

Border Caps need to have a tolerance that is effectively 10%.

Configuration

Code	Description
B	Single-Sided
E	Double-Sided



Ordering information - SLC - Border Cap®

D	10	BN	100	K	1	E	X	
Product	Case Size	Material	Capacitance (pF)	Tolerance	Voltage	Termination	Test Level	Packaging
D = Border Cap®	10 12 15 20 25 30 35 40 50	See material tables on Page 3.	R02 = 0.02 pF OR5 = 0.5 pF 1R0 = 1.0 pF 5R1 = 5.1 pF 100 = 10 pF 101 = 100 pF 152 = 1500 pF Refer to Capacitance range tables for available values. Consult an inside sales rep. for custom solutions.	A = ±0.05pF B = ±0.10pF C = ±0.25pF D = ±0.5pF F = ±1% G = ±2% J = ±5% K = ±10% L = ±15% M = ±20% Z = +80% -20%	2 = 25V* 5 = 50V *For Capacitors with UX material only	P = Ni / Au B = Single Border E = Double Border M = Au	Y X A B D E See test level definitions on page 5.	B = Black Dotted E = Repopulated T = Tape and Reel Leave blank for generic waffle pack. See packaging definitions on Page 6.

Dimensions

Style	Length / Width	Pad Size	Border	Thickness
D10	0.010" ±0.001" (0.254mm ±0.025)	0.008" (0.203mm)	0.001" (0.025mm)	0.006" ±0.0025" (0.152mm ± 0.064mm)
D12	0.012" ±0.001" (0.305mm ±0.025)	0.010" (0.254mm)	0.001" (0.025mm)	0.006" ±0.0025" (0.152mm ± 0.064mm)
D15	0.015" ±0.001" (0.381mm ±0.025)	0.011" (0.279mm)	0.002" (0.051mm)	0.006" ±0.0025" (0.152mm ± 0.064mm)
D20	0.020" ±0.001" (0.508mm ±0.025)	0.016" (0.406mm)	0.002" (0.051mm)	0.006" ±0.0025" (0.152mm ± 0.064mm)
D25	0.025" ±0.001" (0.635mm ±0.025)	0.021" (0.533mm)	0.002" (0.051mm)	0.006" ±0.0025" (0.152mm ± 0.064mm)
D30	0.030" ±0.001" (0.762mm ±0.025)	0.026" (0.660mm)	0.002" (0.051mm)	0.006" ±0.0025" (0.152mm ± 0.064mm)
D35	0.035" ±0.001" (0.889mm ±0.025)	0.031" (0.787mm)	0.002" (0.051mm)	0.006" ±0.0025" (0.152mm ± 0.064mm)
D40	0.040" ±0.001" (1.016mm ±0.025)	0.036" (0.914mm)	0.002" (0.051mm)	0.006" ±0.0025" (0.152mm ± 0.064mm)
D50	0.012" ±0.001" (1.27mm ±0.025)	0.046" (1.168mm)	0.002" (0.051mm)	0.006" ±0.0025" (0.152mm ± 0.064mm)

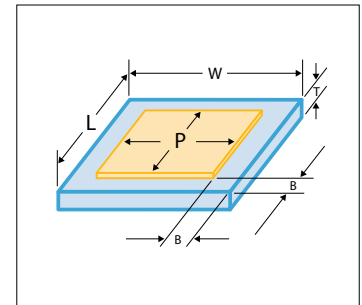

*UX material available in 25V (0.006" Thick) and 50V (0.010" Thick)

Capacitance values - Single-sided

Style	D10		D12		D15		D20		D25		D30		D35		D40		D50										
	MIN.	MAX.	MIN.	MAX.	MIN.	MAX.	MIN.	MAX.	MIN.	MAX.	MIN.	MAX.	MIN.	MAX.	MIN.	MAX.	MIN.	MAX.									
CAPACITANCE (pF)																											
PI	0.03	0.05	P,K	0.05	0.07	P,K	0.06	0.09	P,K	0.15	0.15	A,K	0.2	0.3	A,K	0.3	0.45	A,K	0.35	0.6	A,B,K	0.5	0.7	A,B,K	0.8	1.1	B,K
PG	0.04	0.06	P,K	0.06	0.09	P,K	0.08	0.1	P,K	0.15	0.2	A,K	0.25	0.4	A,K	0.35	0.55	A,K	0.5	0.8	A,B,K	0.65	0.95	B,K	1	1.5	B,K
AH	0.06	0.1	P,K	0.09	0.1	P,K	0.15	0.2	A,K	0.25	0.35	A,K	0.4	0.6	A,K	0.55	0.9	B,K	0.75	1.2	B,K	1	1.4	B,K	1.5	2.2	K
CF	0.07	0.1	P,K	0.1	0.15	P,K	0.15	0.2	A,K	0.25	0.45	A,K	0.45	0.7	B,K	0.65	1	B,K	0.8	1.3	B,K	1	1.6	K	1.7	2.4	K
NA	0.07	0.1	P,K	0.15	0.15	A,K	0.15	0.2	A,K	0.25	0.45	A,K	0.45	0.7	B,K	0.65	1	B,K	0.85	1.5	B,K	1.2	1.7	K	1.8	2.7	K
CD	0.15	0.15	A,K	0.2	0.25	A,K	0.25	0.35	A,K	0.45	0.7	B,K	0.7	1.1	B,K	0.95	1.6	C,K	1.4	2.2	C,K	1.8	2.7	K	2.7	4.3	K
CG	0.25	0.35	A,K	0.3	0.5	A,K	0.45	0.7	B,K	0.8	1.3	C,K	1.3	2	C,K	1.8	3	D,K	2.7	4.3	D,K	3.3	5.1	K	5.1	8.2	K
DB	0.25	0.35	A,K	0.35	0.5	A,K	0.45	0.7	B,K	0.8	1.3	C,K	1.3	2.2	C,K	1.9	3	D,K	2.7	4.3	D,K	3.6	5.1	K	5.6	8.2	K
NP	0.25	0.4	A,K	0.4	0.6	B,K	0.55	0.85	B,K	0.95	1.6	C,K	1.5	2.4	C,K	2.2	3.6	D,K	3	5.1	D,K	4.3	6.2	K	6.2	10	K
NR	0.5	0.8	B,K	0.7	1.1	B,K	1	1.6	C,K	1.8	3	D,K	3	4.7	D,K	4.3	6.8	K	6.2	10	K	7.5	11	K	12	18	K
NS	0.9	1.5	C,K	1.3	2.2	C,K	1.9	3	D,K	3.6	5.6	D,K	5.6	9.1	K	8.2	13	K	11	18	K	15	22	K	22	33	K
NU	1.8	3	D,K	2.7	4.3	D,K	3.9	5.6	K	6.8	11	K	11	18	K	16	27	K	22	36	K	30	43	K	47	68	K
NV	2.7	4.3	D,K	3.9	6.2	K	5.6	8.2	K	10	16	K	16	27	K	24	39	K	33	56	K	43	62	K	68	100	K
BD	2.2	3.3	K	3	5.1	K	4.3	6.8	K	8.2	13	K	13	20	K	18	30	K	27	43	K	33	51	K	51	82	K
BC	3.9	6.2	K	5.6	9.1	K	8.2	13	K	15	24	K	24	39	K	36	56	K	47	75	K	62	91	K	100	150	K
BE	3.6	6.2	K	5.6	9.1	K	8.2	12	K	15	22	K	24	36	K	33	56	K	47	75	K	62	91	K	91	130	K
BL	6.2	10	K,M	9.1	13	K,M	13	20	K,M	24	36	K,M	36	56	K,M	56	91	K,M	75	120	K,M	100	130	K,M	150	220	K,M
BJ	10	16	K	15	24	K	20	33	K	39	62	K	62	100	K	91	150	K	120	200	K	160	240	K	270	390	K
BN	13	22	K,M	20	33	K,M	30	43	K,M	51	82	K,M	82	130	K,M	120	200	K,M	160	270	K,M	220	330	K,M	330	510	K,M
BU	27	43	M	36	62	M	56	82	M	100	160	M	150	240	M	220	360	M	300	510	M	430	620	M	620	1000	M
BV	39	68	M	62	100	M	82	130	M	150	240	M	240	390	M	360	560	M	510	820	M	680	1000	M	1000	1500	M

UX Material Capacitance Table (all values M tolerance ±20%)

VOLTAGE	MIN.	MAX.	MIN.	MAX.	MIN.	MAX.	MIN.	MAX.	MIN.	MAX.	MIN.	MAX.	MIN.	MAX.	MIN.	MAX.	MIN.	MAX.
25V	82	100	120	140	160	200	300	370	490	590	710	860	1000	1200	1300	1600	2000	2400
50V					100	140	200	240	300	370	450	540	600	750	800	950	1300	1500

Capacitance values - Double-sided

Style	D10		D12		D15		D20		D25		D30		D35		D40		D50										
	MIN.	MAX.	MIN.	MAX.	MIN.	MAX.	MIN.	MAX.	MIN.	MAX.	MIN.	MAX.	MIN.	MAX.	MIN.	MAX.	MIN.	MAX.									
CAPACITANCE (pF)																											
PI	0.03	0.04	P,K	0.04	0.06	P,K	0.06	0.08	P,K	0.1	0.15	A,K	0.2	0.25	A,K	0.25	0.4	A,K	0.35	0.55	A,B,K	0.45	0.65	A,B,K	0.7	1.1	B,K
PG	0.04	0.06	P,K	0.06	0.08	P,K	0.07	0.1	P,K	0.15	0.2	A,K	0.25	0.35	A,K	0.35	0.5	A,K	0.45	0.7	A,B,K	0.6	0.9	B,K	0.95	1.4	B,K
AH	0.06	0.09	P,K	0.09	0.1	P,K	0.15	0.15	A,K	0.2	0.2	A,K	0.35	0.5	A,K	0.5	0.8	A,B,K	0.7	1.1	B,K	0.9	1.3	B,K	1.4	2.2	K
CF	0.07	0.1	P,K	0.1	0.15	A,K	0.15	0.15	A,K	0.25	0.35	A,K	0.4	0.65	B,K	0.6	0.95	B,K	0.8	1.3	B,K	1.1	1.6	K	1.7	2.4	K
NA	0.07	0.1	P,K	0.09	0.15	A,K	0.15	0.15	A,K	0.25	0.35	A,K	0.4	0.6	B,K	0.55	0.9	B,K	0.75	1.2	B,K	1	1.5	K	1.6	2.4	K
CD	0.15	0.15	A,K	0.15	0.25	A,K	0.2	0.3	A,K	0.4	0.6	B,K	0.6	1	B,K	0.9	1.5	C,K	1.3	2	C,K	1.7	2.4	K	2.7	3.9	K
CG	0.2	0.3	A,K	0.3	0.45	A,K	0.4	0.55	A,K	0.7	1.1	B,K	1.2	1.9	C,K	1.7	2.7	C,K	2.4	3.9	D,K	3.3	4.7	K	5.1	7.5	K
DB	0.25	0.35	A,K	0.35	0.5	A,K	0.5	0.7	B,K	0.9	1.3	C,K	1.4	2.1	C,K	2	3.1	D,K	2.8	4.3	D,K	3.6	5.6	K	5.6	9.1	K
NP	0.25	0.4	A,K	0.4	0.6	B,K	0.55	0.8	B,K	1	1.5	C,K	1.7	2.5	C,K	2.4	3.7	D,K	3.3	5.1	D,K	4.3	6.8	K	6.8	10	K
NR	0.45	0.7	B,K	0.65	1.1	B,K	0.85	1.3	C,K	1.6	2.4	C,K	2.7	4.3	D,K	3.9	6.2	D,K	5.6	9.1	K	7.5	11	K	12	16	K
NS	0.85	1.3	C,K	1.3	2	C,K	1.6	2.4	D,K	3	4.7	D,K	5.1	8.2	K	7.5	12	K	10	16	K	15	20	K	22	33	K
NU	1.7	2.7	D,K	2.7	3.9	D,K	3.3	4.7	K	6.2	9.1	K	10	16	K	15	24	K	20	33	K	27	39	K	43	62	K
NV	2.7	3.9	D,K	3.9	6.2	K	5.1	6.8	K	9.1	13	K	15	24	K	22	36	K	30	51	K	43	62	K	68	100	K
BD	2	3	K	3	4.7	K	3.9	5.6	K	7.5	11	K	12	18	K	18	27	K	24	39	K	33	47	K	51	75	K
BC	3.6	5.6	K	5.6	8.2	K	6.8	10	K	13	20	K	22	33	K	33	51	K	43	68	K	62	82	K	91	130	K
BE	3.6	5.6	K	5.1	8.2	K	6.8	10	K	13	20	K	22	33	K	30	51	K	43	68	K	56	82	K	91	130	K
BL	5.6	9.1	K,M	8.2	13	K,M	11	16	K,M	20	30	K,M	33	51	K,M	51	82	K,M	68	110	K,M	91	130	K,M	150	220	K,M
BJ	9.1	15	K	15	22	K	18	27	K	33	51	K	56	82	K	82	130	K	110	180	K	150	220	K	240	360	K
BN	13	20	K,M	20	30	K,M	24	36	K,M	47	68	K,M	75	120	K,M	110	180	K,M	150	240	K,M	200	300	K,M	330	470	K,M
BU	24	39	M	36	56	M	47	68	M	91	130	M	150	220	M	220	330	M	300	470	M	390	560	M	620	910	M
BV																											

Description

High Performance Single Layer Capacitors for RF, Microwave and Millimeter Wave Applications.

- Wire Bondable:
100μ" Au with a Ni Barrier Layer
- Customized solutions available, please contact sales office

Functional Applications

- DC Blocking
- RF Bypassing
- Filtering
- Tuning
- Insulation
- Submounts
- Stand-Offs

Benefits

- Dimensional consistency
- Gold metallization for wire bonding
- Rugged construction

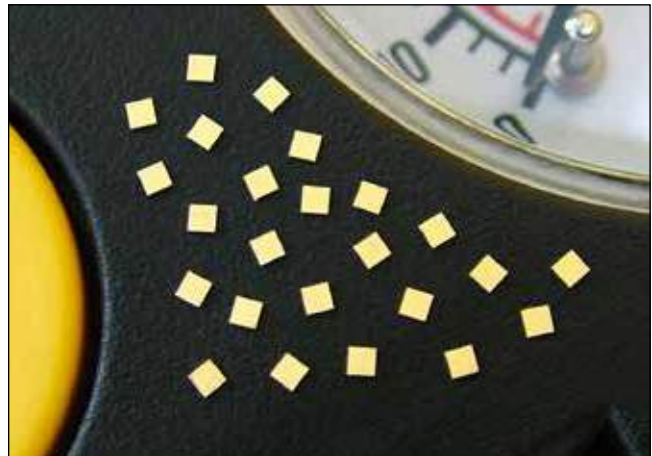

Test Level Codes

Commercial Level	
Y	1% AQL 2-Side Visual
X	100% 4-Side Visual 1% AQL Electrical (CAP/DF/IR & DWV)

High Reliability

A	MIL-PRF-49464 Group A • 100% Thermal Shock • 100% Voltage Conditioning • 100% Electrical (CAP/DF/IR & DWV) • 100% 6-Side Visual • Bond Strength • Die Shear • Temperature Coefficient	B	MIL-PRF-49464 Group B • MIL-PRF-49464 Group A • Immersion • Low Voltage Humidity • Life
		D	• Customer Defined
		E	• 6-Side Visual

Dimensions

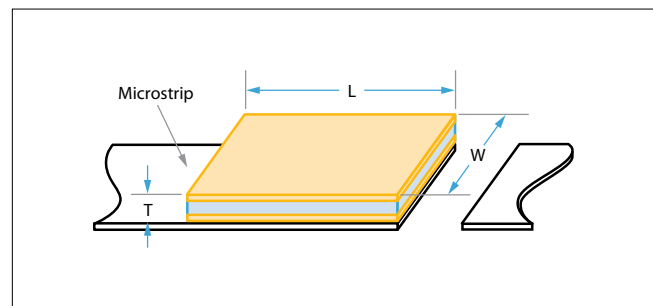

Ordering information - SLC - T-Cap®

T	30	BV	30	X	45	P	X	
Product	Width	Material	Length	Tolerance	Thickness	Termination	Test Level	Packaging
T = T-Cap®	Two digit number representing the Width in .001" For Widths >.099", Consult an inside sales rep.	See material tables on Page 3.	Two digit number representing the Length in .001" For Lengths >.099", Consult an inside sales rep.	X = Length & Width: ± .001", Thickness: -.0005" S = Special	35 – 99 Represents thickness in .0001" K0 = .010" M0 = .020" Examples: 55 = .0055" K2 = .012" M5 = .025"	P = Ni / Au T = Ni / AuSn M = Au	Y X See test level definitions on page 5.	T = Tape and Reel Leave blank for generic waffle pack. See packaging definitions on Page 7.

Description

High Performance Single Layer Capacitors for RF, Microwave and Millimeter Wave Applications.

- Available from 0.03pF to 10,000pF
- Operating frequency up to 100GHz
- Wire Bondable:
- Customized solutions are available, please contact sales office

Functional Applications

- DC Blocking
- RF Bypassing
- Filtering
- Tuning and Coupling

Benefits

- ESD Proof
- Gold metallization for wire bonding
- Rugged construction



Test Level Codes

Commercial Level	
Y	1% AQL 2-Side Visual
X	100% 4-Side Visual 1% AQL Electrical (CAP/DF/IR & DWV)

High Reliability

A	MIL-PRF-49464 Group A	B	MIL-PRF-49464 Group B
	<ul style="list-style-type: none"> • 100% Thermal Shock • 100% Voltage Conditioning • 100% Electrical (CAP/DF/IR & DWV) • 100% 6-Side Visual • Bond Strength • Die Shear • Temperature Coefficient 		<ul style="list-style-type: none"> • MIL-PRF-49464 Group A • Immersion • Low Voltage Humidity • Life
			D
		E	• 6-Side Visual

Voltage

Code	Voltage
2	25 Volts
5	50 Volts
1	100 Volts

Tolerance

Code	Description
P	± 0.01pF
A	± 0.05pF
B	± 0.1pF
C	± 0.25pF
D	± 0.50pF
K	± 10%
L	± 15%
M	± 20%
X	GMV (Guarantee Minimum Value)
Z	+80%, -20%

Border Caps need to have a tolerance that is effectively 10%.

Ordering information - SLC - Di-Cap®

D	10	CF	OR1	B	5	P	X	
Product	Case Size	Material	Capacitance (pF)	Tolerance	Voltage	Termination	Test Level	Packaging
D = Di-Cap®	10 12 15 20 25 30 35 50 70 90	See material tables on Page 3.	R02 = 0.02 pF OR5 = 0.5 pF 1R0 = 1.0 pF 5R1 = 5.1 pF 100 = 10 pF 101 = 100 pF 432 = 4300 pF Refer to Capacitance range tables for available values. Consult an inside sales rep. for custom solutions.	A = ±0.05pF B = ±0.10pF C = ±0.25pF D = ±0.5pF F = ±1% G = ±2% J = ±5% K = ±10% L = ±15% M = ±20% Z = +80% -20%	2 = 25V 5 = 50V 1 = 100V	P = Ni / Au T = Ni / AuSn M = Au L = Single Beam Lead A = Axial Beam Lead S = Standing Axial Beam Lead D = Special Z = Tin Copper Ribbon	Y X A B D E See test level definitions on page 5.	T = Tape and Reel Leave blank for generic waffle pack. See packaging definitions on Page 7.

Style	Length	Width	Thickness	
			50 Volt	100 Volt
D10	0.010" Max. (0.254mm Max.)	0.010" +0/-0.003" (0.254mm +0/-0.076mm)	0.004" ±0.001" (0.102mm ±0.025mm)	-
D12	0.015" Max. (0.381mm Max.)	0.012" +0.002"/-0.003" (0.305mm +0.051mm/-0.076mm)	0.004" ±0.001" (0.102mm ±0.025mm)	-
D15	0.020" Max. (0.508mm Max.)	0.015" +0/-0.003" (0.381mm +0/-0.076mm)	0.004" ±0.001" (0.102mm ±0.025mm)	0.006" ±0.001" (0.152mm ±0.025mm)
D20	0.020" Max. (0.508mm Max.)	0.020" +0/-0.003" (0.508mm +0/-0.076mm)	0.004" ±0.001" (0.102mm ±0.025mm)	0.006" ±0.001" (0.152mm ±0.025mm)
D25	0.030" Max. (0.762mm Max.)	0.025" +0/-0.003" (0.635mm +0/-0.076mm)	0.004" ±0.001" (0.102mm ±0.025mm)	0.006" ±0.001" (0.152mm ±0.025mm)
D30	0.030" Max. (0.762mm Max.)	0.030" +0/-0.003" (0.762mm +0/-0.076mm)	0.004" ±0.001" (0.102mm ±0.025mm)	0.006" ±0.001" (0.152mm ±0.025mm)
D35	0.040" Max. (1.016mm Max.)	0.035" ±0.005" (0.889mm ±0.127mm)	0.004" ±0.001" (0.102mm ±0.025mm)	0.007" ±0.002" (0.178mm ±0.051mm)
D50	0.060" Max. (1.524mm Max.)	0.050" ±0.010" (1.270mm ±0.254mm)	-	0.007" ±0.002" (0.178mm ±0.051mm)
D70	0.080" Max. (1.778mm Max.)	0.070" ±0.010" (1.778mm ±0.254mm)	-	0.007" ±0.002" (0.178mm ±0.051mm)
D90	0.100" Max. (2.54mm Max.)	0.090" ±0.010" (2.286mm ±0.254mm)	-	0.007" ±0.002" (0.178mm ±0.051mm)

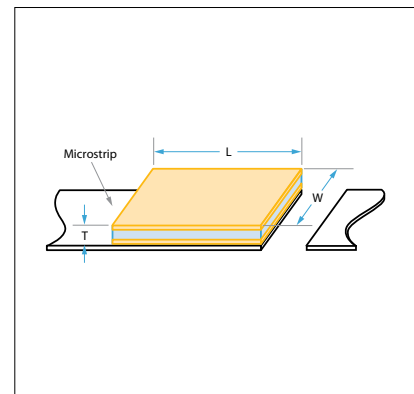

*UX material available in 25V (0.006" Thick) and 50V (0.010" Thick)

Capacitance values - 50 Volt Rated Di-Cap[®]

Style	D10		D12		D15		D20			D25			D30			D35					
	MIN.	MAX.	TOL.	MIN.	MAX.	TOL.	MIN.	MAX.	TOL.	MIN.	MAX.	TOL.	MIN.	MAX.	TOL.	MIN.	MAX.	TOL.			
CAPACITANCE (pF)																					
MATERIAL	MIN.	MAX.	TOL.	MIN.	MAX.	TOL.	MIN.	MAX.	TOL.	MIN.	MAX.	TOL.	MIN.	MAX.	TOL.	MIN.	MAX.	TOL.	MIN.	MAX.	TOL.
PI	0.03	0.05	P	0.04	0.1	P	0.06	0.15	P	0.09	0.2	P,A	0.2	0.4	A,B	0.25	0.45	A,B	0.35	0.85	A,B
PG	0.04	0.06	P	0.06	0.1	P	0.08	0.2	P,A	0.15	0.3	P,A	0.2	0.4	A,B	0.35	0.8	A,B	0.45	0.95	A,B
AH	0.06	0.1	P	0.08	0.2	P,A	0.15	0.3	P,A	0.2	0.4	A,B	0.35	0.8	A,B	0.45	0.95	A,B	0.7	1.8	A,B,C
CF	0.07	0.1	P	0.1	0.25	P,A	0.15	0.35	P,A	0.2	0.5	P,A,B	0.45	0.95	A,B	0.55	1.1	A,B	0.85	2	A,B,C
NA	0.06	0.1	P	0.09	0.2	P,A	0.15	0.3	P,A	0.2	0.45	A,B	0.4	0.9	A,B	0.5	1	A,B	0.8	1.9	B,C
CD	0.1	0.15	P	0.15	0.35	P,A	0.25	0.55	A,B	0.35	0.75	A,B	0.65	1.5	A,B,C	0.85	1.8	B,C	1.3	3.3	B,C
CG	0.2	0.35	P,A	0.3	0.75	A,B	0.45	1.1	A,B	0.65	1.4	A,B,C	1.2	2.7	B,C	1.6	3.3	B,C	2.7	6.2	C,D
NP	0.25	0.4	A	0.35	0.9	A,B	0.5	1.3	A,B,C	0.75	1.8	B,C	1.5	3.3	C,D	1.9	3.9	C,D	3	7.5	C,D
NR	0.45	0.8	A,B	0.65	1.7	B,C	1	2.4	B,C	1.5	3.3	C,D	2.7	6.2	C,D,K	3.6	7.5	D	5.6	13	D,J,K
NS	0.8	1.5	B,C	1.2	3	B,C	1.8	4.7	C,D	2.7	6.2	C,D	5.1	12	,K	6.8	13	K	11	27	K
NU	1.6	3	B,C	2.4	6.2	C,D	3.6	9.1	D,K	5.6	12	D,K	11	24	K	15	27	K	22	51	K
NV	2.4	4.3	C,D	3.6	9.1	D,K	5.6	13	D,K	8.2	18	K	16	36	K	20	43	K	33	75	K
BD	1.8	3.6	K	3	7.5	K	4.3	11	K	6.2	13	K	12	27	K	16	33	K	27	62	K
BC	3.6	6.2	K	5.1	13	K	7.5	20	K	12	27	K	22	51	K	30	62	K	47	110	K
BE	3.3	6.2	K	5.1	13	K	7.5	18	K	12	24	K	22	51	K	30	62	K	47	110	K
BL	5.6	10	K,M	8.2	20	K,M	12	30	K,M	18	39	K,M	36	82	K,M	47	91	K,M	75	180	K,M
BJ	9.1	16	K	13	33	K	20	51	K	30	68	K	56	130	K	75	160	K	120	270	K
BN	12	22	K,M	18	47	K,M	27	68	K,M	43	91	K,M	82	180	K,M	100	220	K,M	160	390	K,M
BU	22	43	M	36	91	M	51	130	M	75	180	M	150	330	M	200	390	M	300	750	M
BV	36	68	M	56	130	M	82	200	M	120	270	M	240	510	M	300	620	M	510	1200	M

Capacitance values - 100 Volt Rated Di-Cap[®]

Style	D15		D20		D25		D30			D35			D50			D70			D90		
	MIN.	MAX.	TOL.	MIN.	MAX.	TOL.	MIN.	MAX.	TOL.	MIN.	MAX.	TOL.	MIN.	MAX.	TOL.	MIN.	MAX.	TOL.	MIN.	MAX.	TOL.
CAPACITANCE (pF)																					
MATERIAL	MIN.	MAX.	TOL.	MIN.	MAX.	TOL.	MIN.	MAX.	TOL.	MIN.	MAX.	TOL.	MIN.	MAX.	TOL.	MIN.	MAX.	TOL.	MIN.	MAX.	TOL.
PI	0.04	0.1	P	0.06	0.1	P	0.15	0.25	P,A	0.15	0.3	P,A	0.2	0.55	A,B	0.5	1.3	A,B	0.95	2	B,C
PG	0.06	0.1	P	0.08	0.15	P	0.2	0.35	A	0.2	0.4	A,B	0.25	0.75	A,B	0.6	1.7	B,C	1.2	2.7	B,C
AH	0.08	0.2	P,A	0.15	0.25	P,A	0.25	0.5	A,B	0.35	0.65	A,B	0.4	1.2	A,B,C	0.95	2.7	B,C	1.9	3.9	B,C
CF	0.1	0.25	P,A	0.15	0.3	P,A	0.3	0.65	A,B	0.4	0.75	A,B	0.45	1.4	A,B,C	1.1	3	B,C	2.4	4.7	C,D
NA	0.09	0.2	P,A	0.15	0.3	P,A	0.3	0.6	A,B	0.35	0.7	A,B	0.45	1.3	A,B,C	1.1	3	B,C	2.2	4.3	C,D
CD	0.15	0.35	P,A	0.25	0.5	A,B	0.45	1	A,B	0.6	1.2	A,B,C	0.7	2.2	B,C	1.7	4.7	C,D	3.6	7.5	C,D
CG	0.3	0.7	A,B	0.45	0.95	A,B	0.85	1.9	A,B,C	1.1	2.2	B,C	1.3	3.9	B,C,D	3.3	9.1	C,D,K	6.8	13	D,K
DB	0.3	0.75	A,B	0.45	1	A,B	0.85	1.9	B,C	1.1	2.2	B,C	1.4	4.3	C,D	3.3	9.1	C,D,K	6.8	15	D,K
NP	0.35	0.85	A,B	0.55	1.2	B,C	1	2.2	B,C	1.3	2.7	B,C,D	1.6	5.1	C,D	3.9	11	C,D,K	8	16	J,K
NR	0.65	1.6	B,C	1	2.2	B,C	1.9	4.3	C,D	2.7	5.1	C,D	3	9.1	D,K	7.5	20	J,K	15	33	J,K
NS	1.2	3	C,D	1.9	3.9	C,D	3.6	8.2	D,K	4.7	9.1	D,K	5.6	18	K	15	39	K	30	62	K
NU	2.4	6.2	C,D	3.9	8.2	C,D,K	7.5	16	D,J,K	9.1	18	J,K	12	36	J,K	30	82	J,K	56	120	K
NV	3.6	9.1	D,K	5.6	12	D,K	11	24	K	15	27	K	18	51	K	43	120	K	91	180	K
BD	3	6.8	K	4.3	9	K	8	18	K	11	22	K	13	39	K	33	91	K	68	130	K
BC	5.6	13	K	8	18	K	16	33	K	20	43	K	24	75	K	62	160	K	120	270	K
BE	5.1	13	K	8	16	K	15	33	K	20	39	K	24	75	K	62	160	K	120	240	K
BL	8.2	20	K,M	13	27	K,M	24	51	K,M	33	62	K,M	39	120	K,M	100	270	K,M	200	390	K,M
BJ	13	33	K	20	47	K	39	82	K	51	100	K	62	180	K	160	430	K	330	680	K
BN	18	47	K,M	30	62	K,M	56	120	K,M	68	130	K,M	91	270	K,M	220	560	K,M	430	910	K,M
BU	36	82	M	56	120	M	100	220	M	130	270	M	160	510	M	390	1100	M	820	1600	M
BV	56	130	M	82	180	M	160	360	M	220	430	M	270	750	M	620	1800	M	1300	2700	M

UX Material Capacitance Table

Style	D10		D12		D15		D20		D25		D30		D35		D50		D70		D90	
	MIN.	MAX.	MIN.	MAX.	MIN.	MAX.	MIN.	MAX.	MIN.	MAX.	MIN.	MAX.	MIN.	MAX.	MIN.	MAX.	MIN.	MAX.	MIN.	MAX.
CAPACITANCE (pF)																				
MATERIAL	MIN.	MAX.	MIN.	MAX.	MIN.	MAX.	MIN.	MAX.	MIN.	MAX.	MIN.	MAX.	MIN.	MAX.	MIN.	MAX.	MIN.	MAX.	MIN.	MAX.
25V	51	75	75	180	110	250	170	340	280	650	390	800	620	1400	1600	3200	3500	5900	6200	10000
50V							100	200	170	390	240	470	360	850	940	2000	2100	3500	3700	5500

Description

Multiple Decoupling/Blocking Capacitors in a Single Array.

- Operating frequency up to 30GHz
- Wire Bondable:
- Customized solutions are available, please contact sales office

Functional Applications

- DC Blocking
- RF Bypassing
- Decoupling
- GaAs ICs

Benefits

- Single insertion reduces complexity and cost
- Gold metallization for wire bonding
- Reduce bond wires for improved performance



Test Level Codes

Commercial Level	
Y	1% AQL 2-Side Visual
X	100% 4-Side Visual 1% AQL Electrical (CAP/DF/IR & DWV)

High Reliability

A	MIL-PRF-49464 Group A • 100% Thermal Shock • 100% Voltage Conditioning • 100% Electrical (CAP/DF/IR & DWV) • 100% 6-Side Visual • Bond Strength • Die Shear • Temperature Coefficient	B	MIL-PRF-49464 Group B • MIL-PRF-49464 Group A • Immersion • Low Voltage Humidity • Life
		D	• Customer Defined
		E	• 6-Side Visual

Tolerance

Code	Description
Z	+80%, -20%

Voltage

Code	Voltage
2	25 Volts
5	50 Volts
1	100 Volts

Ordering information - SLC - Bar Cap®

E	40	BU	151	Z	1	P	X	4	
Product	Case Size	Material	Capacitance (pF)	Tolerance	Voltage	Termination	Test Level	Capacitor Quantity (mils)	Packaging
E = Bar Cap®	20 25 30 40	See material tables on Page 3.	800 = 80 pF 101 = 101 pF 121 = 120 pF 151 = 150 pF Consult an inside sales rep. for custom solutions.	Z = +80% -20%	2 = 25V 5 = 50V	P = Ni / Au M = Au	Y X See test level definitions on page 5.	3 4 6 Etc.	T = Tape and Reel Leave blank for generic waffle pack. See packaging definitions on Page 7.

*Custom Solutions are available; however additional tooling costs may apply. Please contact the sales office for more information.

Dimensions

Case Style	No. of Caps	Dimensions			
		Width	Length	Thickness	Pad Size
E20	3	0.020" ±0.003" (0.508mm ±0.076mm)	0.065" ±0.005" (1.651mm ±0.127mm)	See below	0.020" ±0.015" (0.508mm ±0.381mm)
	4		0.085" ±0.005" (2.159mm ±0.127mm)		
	6		0.125" ±0.005" (3.175mm ±0.127mm)		
E25	3	0.025" ±0.003" (0.635mm ±0.076mm)	0.065" ±0.005" (1.651mm ±0.127mm)	See below	0.025" ±0.015" (0.635mm ±0.381mm)
	4		0.085" ±0.005" (2.159mm ±0.127mm)		
	6		0.125" ±0.005" (3.175mm ±0.127mm)		
E30	3	0.030" ±0.003" (0.762mm ±0.076mm)	0.065" ±0.005" (1.651mm ±0.127mm)	See below	0.030" ±0.015" (0.762mm ±0.381mm)
	4		0.085" ±0.005" (2.159mm ±0.127mm)		
	6		0.125" ±0.005" (3.175mm ±0.127mm)		
E40	3	0.040" ±0.003" (1.016mm ±0.076mm)	0.065" ±0.005" (1.651mm ±0.127mm)	See below	0.040" ±0.015" (1.016mm ±0.381mm)
	4		0.085" ±0.005" (2.159mm ±0.127mm)		
	6		0.125" ±0.005" (3.175mm ±0.127mm)		



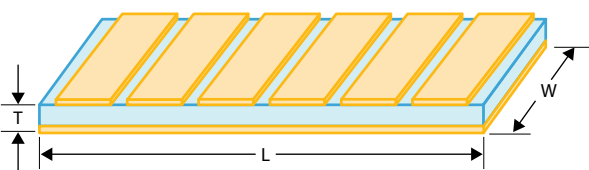

Type	Voltage	Thickness
BU	100V	0.007" ± 0.001" (0.178mm ±0.025mm)
UX	25V	0.006" ± 0.001" (0.152mm ±0.025mm)
	50V	0.010" ±0.001" (0.254mm ±0.025mm)

Capacitance values - Bar Cap®

Part Number	No. of Caps	Value/Cap (pF) BU 100V	Value/Cap (pF) UX 50V	Value/Cap (pF) UX 25V
E20	3	80		340
	4			
	6			
E25	3	100	270	420
	4			
	6			
E30	3	120	320	500
	4			
	6			
E40	3	150	430	690
	4			
	6			

SLC - Gap Cap®

Series Configured Capacitor for Microwave Applications.
Recessed metallization has been designed to minimize the potential of shorting during attachment (epoxy or solder).

- Available from 0.2pF to 800pF
- Operating frequency up to 30GHz
- Customized solutions

Functional Applications

- DC Blocking
- RF Bypassing
- Filtering
- Tuning
- Coupling

Benefits

- Eliminates wire-bonding
- Coplanar waveguide
- Low insertion loss

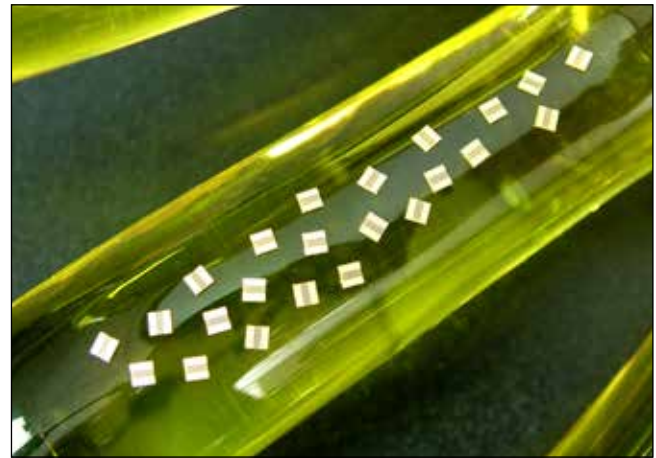

Test Level Codes

Commercial Level	
Y	1% AQL 2-Side Visual
X	100% 4-Side Visual 1% AQL Electrical (CAP/DF/IR & DWV)

High Reliability

A	MIL-PRF-49464 Group A <ul style="list-style-type: none"> • 100% Thermal Shock • 100% Voltage Conditioning • 100% Electrical (CAP/DF/IR & DWV) • 100% 6-Side Visual • Bond Strength • Die Shear • Temperature Coefficient 	B	MIL-PRF-49464 Group B <ul style="list-style-type: none"> • MIL-PRF-49464 Group A • Immersion • Low Voltage Humidity • Life
		D	• Customer Defined
		E	• 6-Side Visual

Tolerance

Code	Description
A	± 0.05pF
B	± 0.1pF
C	± 0.25pF
D	± 0.50pF
K	± 10%
L	± 15%
M	± 20%
X	GMV (Guarantee Minimum Value)
Z	+80%, -20%

Voltage

Code	Voltage
2	25 Volts
5	50 Volts

Ordering information - SLC - Gap Cap®

G	10	BU	100	K	5	P	X	10	
Product	Case Size	Material	Capacitance (pF)	Tolerance	Voltage	Termination	Test Level	Gap Width (mils)	Packaging
G = Gap-Cap®	10 15 20 25 30 35 50	See material tables on Page 3.	R01 = 0.01 pF OR5 = 0.5 pF 1R0 = 1.0 pF 5R1 = 5.1 pF 100 = 10 pF 511 = 510 pF Refer to Capacitance range tables for available values. Consult an inside sales rep. for custom solutions.	A = ±0.05pF B = ±0.10pF C = ±0.25pF D = ±0.5pF F = ±1% G = ±2% J = ±5% K = ±10% L = ±15% M = ±20% Z = +80% -20%	2 = 25V 5 = 50V	P = Ni / Au M = Au	Y X A B D E See test level definitions on page 5.	5 8 10 15	T = Tape and Reel Leave blank for generic waffle pack. See packaging definitions on Page 7.

Dimensions - 25 Volt Gap Cap®

Style	Gap (Nominal)	Dimensions		
		Width	Length	Thickness
G10	0.005" (0.127mm)	0.010" +0/-0.003" (0.254mm +0/-0.076mm)	0.030" Max. (0.762mm Max.)	0.004" ±0.001" (0.102mm ±0.025mm)
G15	0.008" (0.203mm)	0.015" +0/-0.003" (0.381mm +0/-0.076mm)	0.040" Max. (1.016mm Max.)	
G20	0.010" (0.254mm)	0.020" +0/-0.003" (0.508mm +0/-0.076mm)	0.050" Max. (1.270mm Max.)	
G25	0.020" (0.508mm)	0.025" +0/-0.003" (0.635mm +0/-0.076mm)	0.060" Max. (1.524mm Max.)	
G30		0.030" +0/-0.003" (0.762mm +0/-0.076mm)		
G35		0.035" ±0.005" (0.889mm ±0.127mm)		
G50		0.050" ± 0.010" (1.27mm ±0.254mm)	0.080" Max. (2.032mm Max.)	0.006" ±0.001" (0.102mm ±0.064mm)

*UX thickness 0.006" (0.152mm)

Dimensions - 50 Volt Gap Cap®

Style	Gap (Nominal)	Dimensions		
		Width	Length	Thickness
G10	0.005" (0.127mm)	0.010" +0/-0.003" (0.254mm +0/-0.076mm)	0.030" Max. (0.762mm Max.)	0.006" ±0.001" (0.102mm ±0.064mm)
G15	0.008" (0.203mm)	0.015" +0/-0.003" (0.381mm +0/-0.076mm)	0.040" Max. (1.016mm Max.)	
G20	0.010" (0.254mm)	0.020" +0/-0.003" (0.508mm +0/-0.076mm)	0.050" Max. (1.270mm Max.)	
G25	0.020" (0.508mm)	0.025" +0/-0.003" (0.635mm +0/-0.076mm)	0.080" Max. (2.032mm Max.)	
G30		0.030" +0/-0.003" (0.762mm +0/-0.076mm)		
G35		0.035" ±0.005" (0.889mm ±0.127mm)		
G50		0.050" ±0.010" (1.27mm ±0.254mm)		0.006" ±0.001" (0.102mm ±0.064mm)

*UX thickness 0.010" (0.254mm)

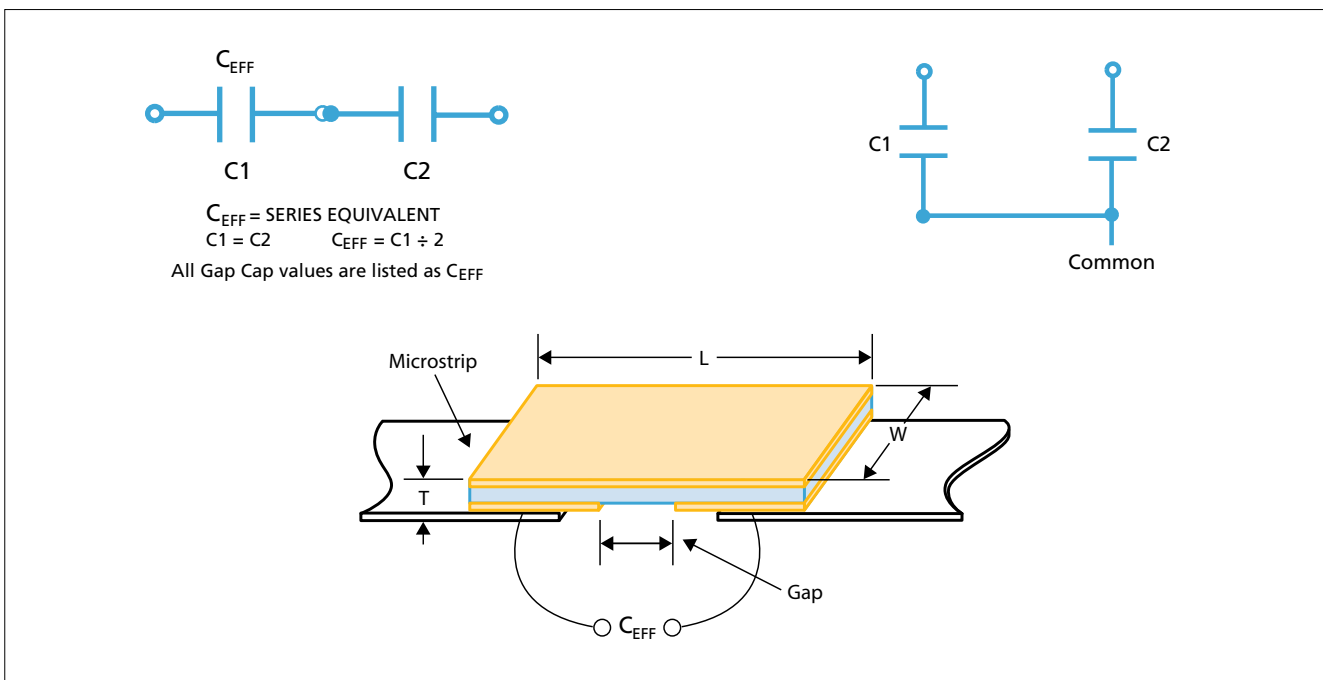

Capacitance values - 25 Volt Gap Cap®

Style	G10			G15			G20			G25			G30			G35			G50		
CAPACITANCE (pF)																					
MATERIAL	MIN	MAX	TOL.	MIN	MAX	TOL.	MIN	MAX	TOL.	MIN	MAX	TOL.	MIN	MAX	TOL.	MIN	MAX	TOL.	MIN	MAX	TOL.
PI	0.02	0.03	A	0.04	0.07	A	0.04	0.10	A	0.05	0.15	A	0.06	0.15	A	0.07	0.20	A			
PG	0.02	0.05	A	0.04	0.10	A	0.05	0.15	A	0.07	0.20	A	0.08	0.25	A	0.09	0.25	A			
AH	0.04	0.08	A	0.06	0.15	A	0.08	0.25	A	0.10	0.30	A	0.15	0.35	A	0.15	0.45	A			
CF	0.04	0.09	A	0.08	0.15	A	0.10	0.30	A	0.15	0.35	A	0.15	0.45	A	0.20	0.50	A			
NA	0.04	0.08	A	0.07	0.15	A	0.09	0.25	A	0.15	0.35	A	0.15	0.40	A	0.15	0.50	A			
CD	0.06	0.10	A	0.15	0.25	A	0.15	0.45	A	0.20	0.60	B	0.25	0.70	B	0.30	0.80	B			
CG	0.15	0.25	A	0.25	0.50	A	0.30	0.90	B	0.35	1.1	B	0.45	1.3	C	0.50	1.6	C			
DB	0.15	0.25	A	0.25	0.55	B	0.30	0.90	B	0.35	1.1	B	0.45	1.4	C	0.50	1.6	C			
NP	0.15	0.30	A	0.30	0.65	B	0.35	1.1	C	0.40	1.3	C	0.55	1.6	C	0.60	1.9	C			
NR	0.25	0.60	A, B	0.50	1.2	B	0.65	2.0	C	0.75	2.4	C	0.95	3.0	D	1.1	3.6	D			
NS	0.50	1.2	B	0.90	2.2	C, K	1.2	3.9	D, K	1.4	4.7	D, K	1.8	5.6	D, K	2.2	6.8	K			
NU	0.95	2.4	C, K	1.8	4.3	C, K	2.4	7.5	D, K	3.0	9.1	D, K	3.6	11	K	4.3	13	K			
NV	1.4	3.6	C, K	2.7	6.8	D, K	3.6	11	D, K	4.3	13	K	5.6	16	K	6.2	20	K			
BD	1.1	2.7	K	2.2	5.1	K	2.7	9.1	K	3.3	11	K	4.3	13	K	5.1	16	K			
BC	2.0	5.1	K	3.9	10	K	5.1	16	K	6.2	20	K	8.2	24	K	9.1	27	K			
BE	2.0	4.7	K	3.9	9.1	K	5.1	16	K	6.2	20	K	7.5	24	K	9.1	27	K			
BL	3.3	7.5	K	6.2	15	K	8.2	24	K	10	30	K	12	39	K	15	43	K			
BJ	5.1	13	K	10	24	K	13	43	K	16	51	K	20	62	K	24	75	K			
BN	7.5	18	K	15	33	K	18	56	K	22	68	K	27	82	K	33	100	K			
BU	15	33	K, M	27	62	K, M	33	110	K, M	43	130	K, M	51	160	K, M	62	180	K, M			
BV	22	51	M	43	100	M	51	160	M	68	200	M	82	240	M	100	300	M			
UX	40	60	M	90	120	M	150	200	M	190	250	M	265	300	M	310	350	M	500	800	M

Capacitance values - 50 Volt Gap Cap®

Style	G10			G15			G20			G25			G30			G35			G50		
CAPACITANCE (pF)																					
MATERIAL	MIN	MAX	TOL.	MIN	MAX	TOL.	MIN	MAX	TOL.	MIN	MAX	TOL.	MIN	MAX	TOL.	MIN	MAX	TOL.	MIN	MAX	TOL.
PI	0.02	0.02	A	0.03	0.05	A	0.03	0.08	A	0.04	0.15	A	0.05	0.15	A	0.06	0.20	A	0.07	0.35	A
PG	0.02	0.03	A	0.03	0.06	A	0.04	0.10	A	0.05	0.20	A	0.07	0.25	A	0.07	0.25	A	0.09	0.50	A
AH	0.03	0.05	A	0.05	0.10	A	0.06	0.15	A	0.08	0.30	A	0.10	0.35	A	0.15	0.45	A	0.15	0.75	A, B
CF	0.03	0.06	A	0.06	0.10	A	0.07	0.20	A	0.09	0.35	A	0.15	0.45	A	0.15	0.50	A	0.20	0.90	A, B
NA	0.03	0.05	A	0.05	0.10	A	0.07	0.15	A	0.08	0.35	A	0.15	0.40	A	0.15	0.45	A	0.20	0.85	A, B
CD	0.04	0.09	A	0.08	0.15	A	0.15	0.30	A	0.15	0.55	A	0.20	0.70	A, B	0.20	0.80	A, B	0.30	1.4	A, B
CG	0.08	0.15	A	0.15	0.35	A	0.20	0.60	A	0.30	1.1	A, B	0.35	1.3	A, B	0.40	1.5	A, B	0.50	2.7	A, B
DB	0.08	0.15	A	0.20	0.35	A	0.25	0.60	A	0.30	1.1	B	0.35	1.3	B, C	0.40	1.6	B, C	0.50	2.7	B, C
NP	0.09	0.20	A	0.20	0.40	A	0.25	0.70	B	0.35	1.3	B, C	0.40	1.6	B, C	0.50	1.9	B, C	0.60	3.3	B, C
NR	0.20	0.40	A	0.35	0.80	B	0.45	1.3	B, C	0.60	2.4	C	0.75	3.0	D	0.90	3.6	D	1.2	6.2	D, K
NS	0.35	0.8	C, K	0.65	1.5	C, K	0.85	2.4	C, K	1.1	4.7	C, K	1.4	5.6	D, K	1.6	6.2	D, K	2.2	11	D, K
NU	0.65	1.6	C, K	1.3	3.0	C, K	1.7	5.1	D, K	2.2	9.1	D, K	3.0	11	K	3.3	13	K	4.3	22	K
NV	0.95	2.4	C, K	2.0	4.7	C, K	2.7	7.5	D, K	3.3	13	D, K	4.3	16	K	5.1	20	K	6.2	33	K
BD	0.75	1.8	K	1.5	3.6	K	2.0	5.6	K	2.7	11	K	3.3	13	K	3.9	15	K	5.1	27	K
BC	1.4	3.3	K	3.0	6.8	K	3.9	11	K	4.7	20	K	6.2	24	K	7.5	27	K	9.1	51	K
BE	1.4	3.3	K	2.7	6.2	K	3.6	10	K	4.7	20	K	6.2	24	K	6.8	27	K	9.1	4.7	K
BL	2.2	5.1	K	4.3	10	K	6.2	16	K	7.5	30	K	10	36	K	11	43	K	15	75	K
BJ	3.6	8.2	K	7.5	16	K	10	27	K	12	51	K	16	62	K	18	68	K	24	120	K
BN	5.1	12	K	10	22	K	13	39	K	18	68	K	22	82	K	24	100	K	33	160	K
BU	9.1	22	M	20	43	M	24	68	M	33	130	M	43	160	M	47	180	M	62	330	M
BV	15	36	M	30	68	M	39	110	M	51	200	M	68	240	M	75	300	M	100	510	M
UX				60	70	M	90	120	M	140	160	M	180	190	M	200	250	M	380	550	M

Binary Tunable Caps for Single-Layer Hybrids.

Functional Applications

- Matching Networks
- Tank Circuits
- Tuning
- Coupling

Benefits

- Small size compatible with microwave geometries
- Hybrid Circuits - Engineering designs
- Operating frequency up to 30GHz
- Customized solutions



Test Level Codes

Commercial Level	
Y	1% AQL 2-Side Visual
X	100% 4-Side Visual 1% AQL Electrical (CAP/DF/IR & DWV)

High Reliability

A	MIL-PRF-49464 Group A • 100% Thermal Shock • 100% Voltage Conditioning • 100% Electrical (CAP/DF/IR & DWV) • 100% 6-Side Visual • Bond Strength • Die Shear • Temperature Coefficient	B	MIL-PRF-49464 Group B • MIL-PRF-49464 Group A • Immersion • Low Voltage Humidity • Life
		D	• Customer Defined
		E	• 6-Side Visual

Tolerance

Code	Description
A	± 0.05pF
B	± 0.1pF
C	± 0.25pF
D	± 0.50pF
K	± 10%
L	± 15%
M	± 20%
X	GMV (Guarantee Minimum Value)
Z	+80%, -20%

Voltage

Code	Voltage
2	25 Volts
5	50 Volts
1	100 Volts

Ordering information - SLC - Bi-Cap[®]

F	15	NR	OR1	M	1	P	X	3	
Product	Case Size	Material	Capacitance (pF)	Tolerance	Voltage	Termination	Test Level	Pad Quantity	Packaging
F = Binary Capacitors	15 20 25 35 40	See material tables on Page 3.	Lowest Value in Series is Part Number R08 = .080 pF OR1 = .1 pF OR2 = .2 pF OR4 = .4 pF OR5 = .5 pF Consult an inside sales rep. for custom solutions.	M = ±20%	2 = 25V 5 = 50V 1 = 100V	P = Ni / Au M = Au	Y X See test level definitions on page 5.	3 4	T = Tape and Reel Leave blank for generic waffle pack. See packaging definitions on Page 7.

Specifications - Bi-Cap[®]

Part Number	No. of Caps	Values (pF)	Voltage (WVDC)	Length	Width	Thickness	Border
F15CGR08M5PX3	3	0.08, 0.15, 0.3	50	0.015" ± 0.001" (0.381mm ± 0.025mm)	0.015" ± 0.001" (0.381mm ± 0.025mm)	0.004" ± 0.001" (0.102mm ± 0.025mm)	0.002" (0.051mm)
F15NR0R1M1PX3	3	0.1, 0.2, 0.4	100	0.015" ± 0.001" (0.381mm ± 0.025mm)	0.015" ± 0.001" (0.381mm ± 0.025mm)	0.006" ± 0.001" (0.152mm ± 0.025mm)	
F20CG0R1M1PX3	3	0.1, 0.2, 0.4	100	0.020" ± 0.001" (0.508mm ± 0.025mm)	0.020" ± 0.001" (0.508mm ± 0.025mm)	0.006" ± 0.001" (0.152mm ± 0.025mm)	
F20NR0R2M1PX3	3	0.2, 0.4, 0.8	100	0.020" ± 0.001" (0.508mm ± 0.025mm)	0.020" ± 0.001" (0.508mm ± 0.025mm)	0.006" ± 0.001" (0.152mm ± 0.025mm)	
F25CFR08M5PX3	3	0.08, 0.15, 0.3	50	0.025" ± 0.001" (0.635mm ± 0.025mm)	0.025" ± 0.001" (0.635mm ± 0.025mm)	0.004" ± 0.001" (0.102mm ± 0.025mm)	
F25CG0R2M1PX3	3	0.2, 0.4, 0.8	100	0.025" ± 0.001" (0.635mm ± 0.025mm)	0.025" ± 0.001" (0.635mm ± 0.025mm)	0.006" ± 0.001" (0.152mm ± 0.025mm)	
F25NR0R4M1PX3	3	0.4, 0.8, 1.6	100	0.025" ± 0.001" (0.635mm ± 0.025mm)	0.025" ± 0.001" (0.635mm ± 0.025mm)	0.006" ± 0.001" (0.152mm ± 0.025mm)	
F35CF0R1M1PX3	3	0.1, 0.2, 0.4	100	0.035" ± 0.001" (0.889mm ± 0.025mm)	0.035" ± 0.001" (0.889mm ± 0.025mm)	0.006" ± 0.001" (0.152mm ± 0.025mm)	
F35CG0R4M1PX3	3	0.4, 0.8, 1.6	100	0.035" ± 0.001" (0.889mm ± 0.025mm)	0.035" ± 0.001" (0.889mm ± 0.025mm)	0.006" ± 0.001" (0.152mm ± 0.025mm)	
F40NR0R5M1PX4	4	0.5, 1, 2, 4	100	0.040" ± 0.001" (1.016mm ± 0.025mm)	0.040" ± 0.001" (1.016mm ± 0.025mm)	0.0075" ± 0.001" (0.191mm ± 0.025mm)	

Dimensions - Bi-Cap[®]

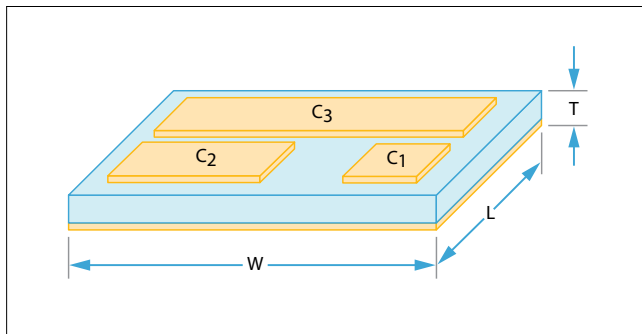

Circuit Diagram - Bi-Cap[®]

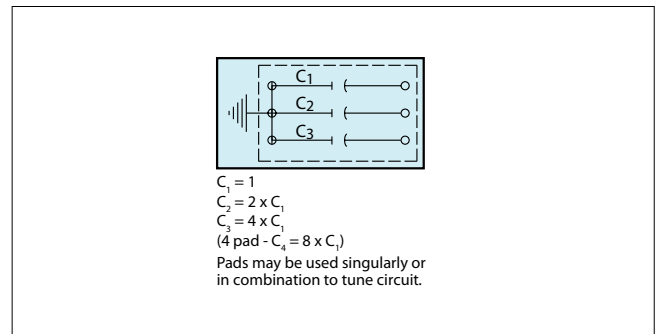

Compex utilizes an extensive variety of materials in both Class I and Class II categories with dielectric constants ranging from 3.8 to 35,000 to fabricate our components. Other dielectric materials are available; please consult the Sales office.

Class I Dielectric Materials:

This class of dielectrics consists of material exhibiting very low losses, extremely low or closely controlled temperature coefficients, negligible voltage and frequency coefficients, negligible aging effects and high insulation and dielectric breakdown.

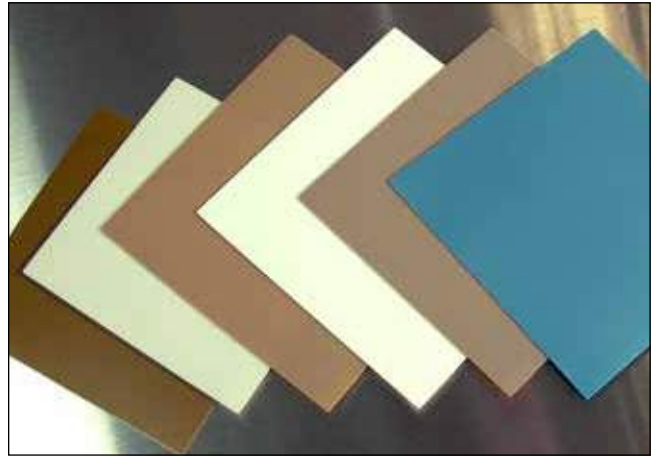

Class I Dielectric Materials

Type	Ins. Res (MEG-OHMS 100VDC @ 25°C)	Temperature Coefficient PPM°C -25 to 125°C	Dissipation Factor (@ 10GHz)	Dielectric Constant (K)	Material
C-20	10 ⁸	Negligible	0.0001	3.8	Quartz
C-20	10 ⁸	Negligible	0.0001	3.9 (SiO ₂)	Si
C-25	10 ⁸	Negligible	0.0001	6.6	BeO
C-28	10 ⁸	P120 ±25	0.0001	8.7	AlN
C-30	10 ⁸	P180 ±50	0.0006	9.6	Alumina 96
C-35	10 ⁸	P180 ±50	0.0006	9.8	Alumina 99.6
C-37	10 ⁸	NPO 0±30	0.0001	12.6	Titanate
C-40	10 ⁸	0 ±30	0.0010	20	Titanate
C-50	10 ⁸	0 ±30	0.0020	40	Titanate
C-55	10 ⁸	0 ±30	0.0050	50	Titanate
C-58	10 ⁸	0 ±30	0.0050	84	Titanate
C-70	10 ⁸	N1500 0±30	0.0025	150	Titanate

*Typically used for submounts and substrates only.

Class II Dielectric Materials:

This class of material is characterized by high dielectric constants, increased losses, and higher temperature coefficients. These properties are inherent with this class of material but the high dielectric constants permit the use of smaller size to achieve low series inductance and meet dimensional requirements. Capacitors made with these materials are often used for coupling of microstrip line circuits where the small chip size is necessary. Used as bypass capacitors, the small size provides low series inductance and dielectric losses are typically of little concern.

Class II Dielectric Materials

Type	Ins. Res (MEG-OHMS 100VDC @ 25°C)	Temperature Coefficient (%) -55 to 125°C	Dissipation Factor (@ 1MHz)	Aging (%) HR/Decade	Dielectric Constant (K)
C-80	10 ⁵	5 to -10	0.010	2.0	300
C-90	10 ⁵	10 to -10	0.015	3.0	1,100
C-100	10 ⁵	3 to -10	0.015	3.5	2,200
C-120	10 ⁵	0 to -35	0.020	3.0	4,000
C-130	10 ⁵	0 to -60	0.025	3.0	5,000
C-140	10 ⁵	0 to -80	0.025	3.0	11,000
C-200	*	15 to -15	0.035	3.0	25,000
C-400	*	15 to -15	0.035	3.0	35,000

* Please consult the factory for specific ratings to meet your application requirements.

New Material

C-400: Ultra High K X7R material.
Capacitance change ±15% from -55 to 125°C.
200pF in a 10 x 10 size.
1,000pF in a 25 x 25 size.

Substrates can be supplied as follows:

- **Bare**
- **Metallized**
 - gold over platinum, palladium, or nickel
 - silver over platinum
 - custom schemes and patterns to customer specifications
- **Thickness range:**
3 mils and up
- **Length and Width:**
up to 4" depending on material

Standard Electrode Metallizations

Gold (G): This metallization consists of a minimum of 70 micro-inches of gold over non-magnetic leach-resistant nickel or platinum which is ideal for all wirebonding methodologies. Please consult our factory for optimum metallization options for solder applications.

Silver (S): This metallization consists of 20 micro-inches of silver over platinum which is ideal for all solder applications whenever the use of gold is unacceptable.

Typical Temperature Characteristics

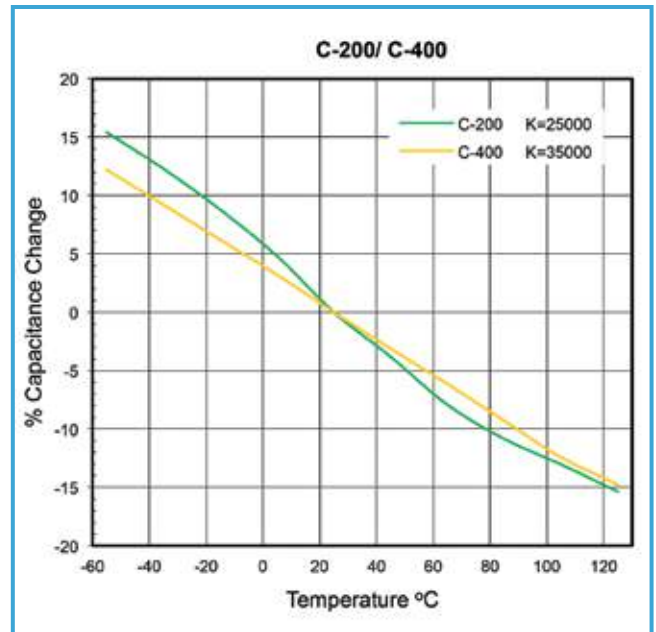
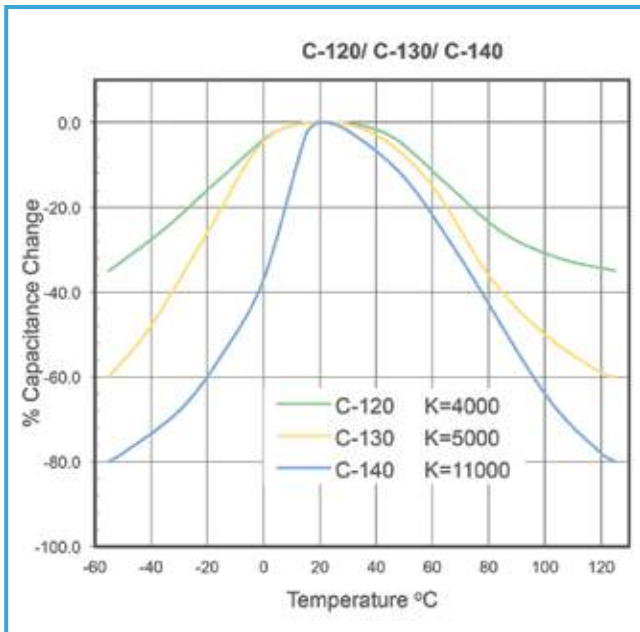
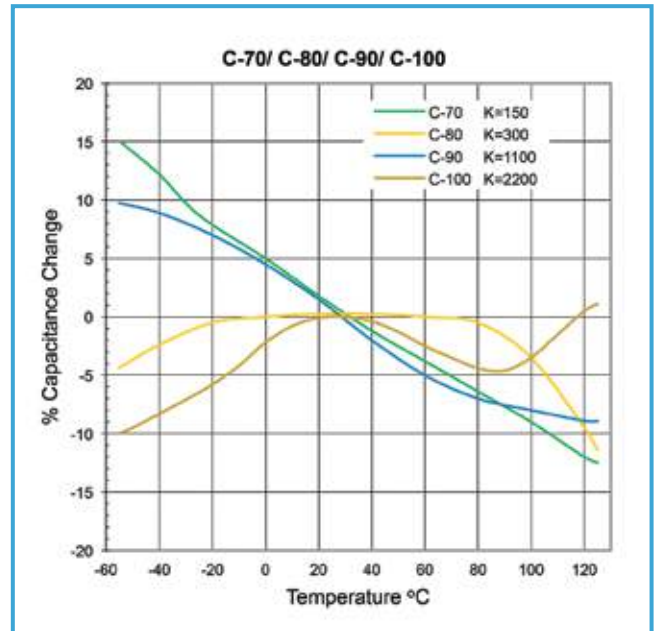
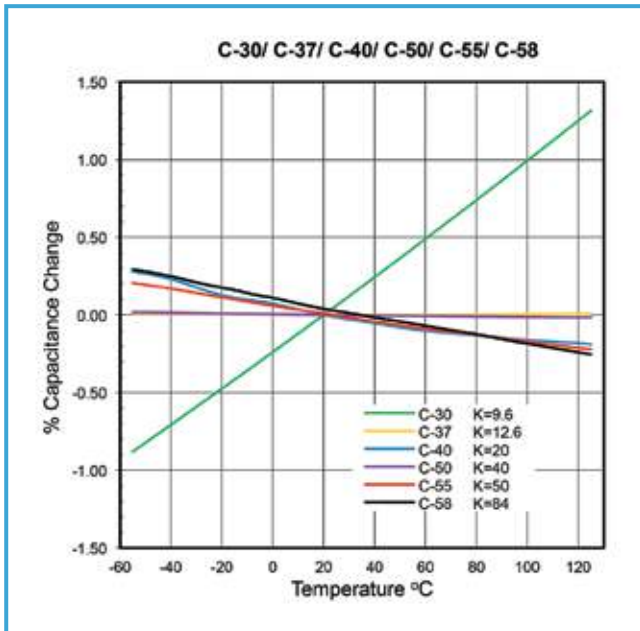

CSA Series - Edge-to-Edge Capacitors



This classic two-electrode design is the simplest and most widely used.

The chip size, shape, and electrical properties may be determined from the dielectric material data and the CSA Selection Chart. Compex is the leader in supplying the LC filter market with custom value parallel plate capacitors. We manufacture tight tolerance, custom filter capacitors to the required size, shape, and value for minimization of post-build tuning requirements. Thicknesses of up to 25+ mils are available utilizing temperature-stable low-loss materials and special terminations to improve the all solder process.

Description

- Capacitance: 0.04 to 10,000 picofarads and beyond
- Square or rectangle, length or width .005" and up

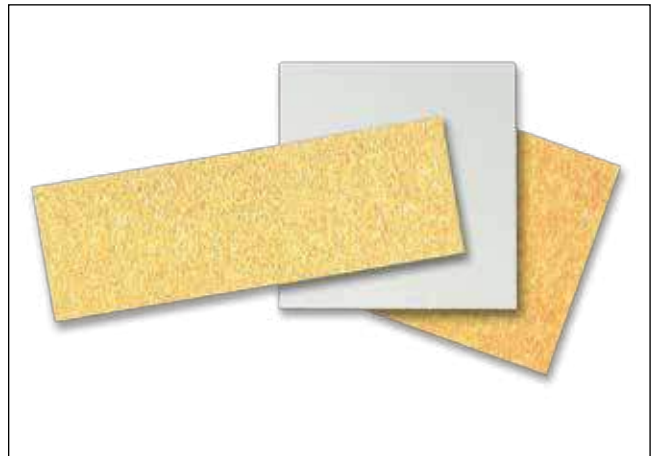

CSA Standard Capacitance Tolerance Codes

Class I Dielectrics: C-20 thru C-70				Class II Dielectrics: C-80 thru C-400			
Tolerance	Code	Tolerance	Code	Tolerance	Code	Tolerance	Code
±.50pF	D	±20%	M	-20% thru +80%	Z	±20%	M
±.25pF	C	±15%	L	-10% thru +40%	Y	±15%	L
±.10pF	B	±10%	K	-0% thru +100%	V	±10%	K
±.05pF	A	±5%	J	Guaranteed Min. Value	GMV	±5%	J
±.01pF	P	±3%	H				
		±2%	G				

CSA Chip Dimensions

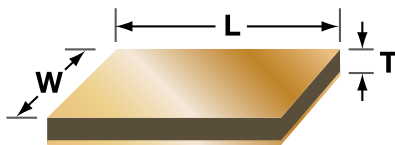

To determine rectangular chip dimensions, divide the total chip area by the required length or width to obtain the remaining dimension.

CSA Standard Dimensional Tolerances

Material	L or W	
	Dimension	Tolerance
C-20 through C-140	< 20 mils	±15%
	≥ 20 mils	±10%
C-200 and C-400	≤ 15 mils	±2 mils
	>15 mils; ≤ 30 mils	±3 mils
	> 30 mils	±5 mils

CSA Electrode Configuration

Two electrodes



Ordering information - CSA Series - Edge-to-Edge Capacitors

CSA	200	10 x 10	x 6	G	101	M
Cap Style	Dielectric Type	Length x Width (mils)	Thickness (mils)	Metallization	Capacitance (pF)	Capacitance Tolerance
	See Class I and Class II tables (page 22)	See CSA Chip Dimensions (at right)	See CSA Selection Chart (at right)	G = Gold S = Silver Custom	First two digits represent significant figures and the last, the number of zeros to follow. When required, the letter "R" is used as a decimal point and the succeeding digits represent significant figures only. e.g.: 101 = 100pF, 1R6 = 1.6pF	See CSA Standard Capacitance Tolerance Codes (below)

Note: Standard dimensional tolerance for length and width is ±15% up to 20 mils. For dimensions greater than 20 mils, standard tolerance is ±10%. For C-200 and C-400 material, see table on right. In cases where dimensions cannot be exceeded, insert "M" to signify a Maximum dimension. The thickness tolerance is ±1.5 mils.

Example shown: Compex Series CSM, dielectric type C-90, .010" x .010" x .005", gold, 2.7pF, ±20% tolerance

Please contact factory to request free samples.

CSA Series - Edge-to-Edge Capacitors



CSA Selection Chart

Note: Selection Chart is for guidance only. All Complex parts are built to specific customer requirements.

Cap. (pF)	Capacitor Size in mils (mm)																		
	10 x 10 (.254 x .254)		12 x 12 (.305 x .305)		15 x 15 (.381 x .381)		20 x 20 (.508 x .508)		25 x 25 (.635 x .635)		30 x 30 (.762 x .762)		35 x 35 (.889 x .889)		40 x 40 (1.016 x 1.016)		50 x 50 (1.27 x 1.27)		
	Diel.	Thick.	Diel.	Thick.	Diel.	Thick.	Diel.	Thick.	Diel.	Thick.	Diel.	Thick.	Diel.	Thick.	Diel.	Thick.	Diel.	Thick.	
0.04	C-30	5	C-30	6	C-30	10													
0.06	C-30	4	C-30	5	C-30	8	C-20	5	C-20	10									
0.08	C-50	10	C-30	4	C-30	6	C-30	10	C-20	7	C-20	9							
0.1	C-50	8	C-50	11	C-30	5	C-30	9	C-20	5	C-20	7	C-20	10					
0.2	C-50	5	C-50	7	C-50	10	C-30	4	C-30	7	C-30	10	C-20	5	C-20	7	C-20	10	
0.3	C-58	6	C-50	4	C-50	6	C-50	11	C-30	4	C-30	7	C-30	9	C-20	5	C-20	7	
0.4	C-58	5	C-58	7	C-50	5	C-50	9	C-50	15	C-30	5	C-30	7	C-30	9	C-20	5	
0.5	C-58	4	C-58	5	C-50	4	C-50	7	C-50	11	C-30	5	C-30	5	C-30	7	C-20	4	
0.6	C-70	6	C-58	5	C-58	7	C-50	6	C-50	10	C-50	15	C-30	4	C-30	6	C-30	9	
0.8	C-80	8	C-70	6	C-58	5	C-50	5	C-50	7	C-50	10	C-50	15	C-30	4	C-30	7	
1	C-80	7	C-70	5	C-58	4	C-58	7	C-50	6	C-50	8	C-50	10	C-30	4	C-30	5	
1.2	C-80	6	C-70	4	C-58	4	C-58	6	C-50	5	C-50	7	C-50	9	C-30	3	C-30	5	
1.5	C-80	5	C-80	7	C-70	5	C-58	5	C-50	4	C-50	6	C-50	7	C-50	10	C-30	4	
1.8	C-80	4	C-80	5	C-70	4	C-58	4	C-58	6	C-50	5	C-50	6	C-50	8	C-50	11	
2	C-80	4	C-80	5	C-70	4	C-70	7	C-58	6	C-50	4	C-50	5	C-50	7	C-50	11	
2.2	C-90	4	C-80	5	C-70	4	C-70	6	C-58	5	C-58	7	C-50	5	C-50	7	C-50	10	
2.7	C-90	8	C-80	4	C-80	6	C-70	5	C-58	4	C-58	6	C-50	4	C-50	5	C-50	8	
3.3	C-90	7	C-90	10	C-80	5	C-70	4	C-70	6	C-58	5	C-58	7	C-50	4	C-50	7	
3.9	C-90	6	C-90	9	C-80	4	C-80	7	C-70	5	C-58	4	C-58	6	C-58	8	C-50	6	
4.7	C-90	5	C-90	7	C-90	11	C-80	6	C-70	4	C-70	6	C-58	5	C-58	6	C-50	5	
5.6	C-90	4	C-90	6	C-90	10	C-80	5	C-80	7	C-70	5	C-58	4	C-58	5	C-50	4	
6.8	C-90	4	C-90	5	C-90	8	C-80	4	C-80	6	C-70	5	C-70	6	C-58	4	C-58	7	
8.2	C-100	6	C-90	4	C-90	7	C-80	4	C-80	5	C-70	4	C-70	5	C-70	7	C-70	10	
10	C-100	5	C-90	4	C-90	5	C-90	9	C-80	4	C-80	6	C-70	4	C-70	5	C-70	8	
12	C-100	4	C-100	6	C-90	5	C-90	8	C-90	11	C-80	5	C-80	7	C-70	4	C-70	7	
15	C-120	6	C-100	5	C-90	4	C-90	6	C-90	10	C-80	4	C-80	6	C-80	7	C-70	6	
18	C-120	5	C-100	4	C-100	6	C-90	5	C-90	8	C-90	11	C-80	4	C-80	6	C-70	5	
20	C-120	5	C-100	4	C-100	6	C-90	5	C-90	8	C-90	11	C-80	4	C-80	5	C-70	4	
22	C-120	4	C-120	6	C-100	5	C-90	4	C-90	7	C-90	9	C-80	4	C-80	5	C-70	4	
27	C-120	4	C-120	5	C-100	4	C-90	4	C-90	6	C-90	8	C-80	3	C-80	4	C-80	6	
33	C-130	4	C-120	4	C-120	6	C-100	6	C-90	5	C-90	6	C-90	11	C-80	4	C-80	5	
39	C-140	6	C-120	4	C-120	5	C-100	5	C-90	4	C-90	5	C-90	7	C-90	10	C-80	4	
47	C-140	5	C-140	7	C-120	5	C-100	4	C-100	6	C-90	5	C-90	6	C-90	8	C-80	4	
56	C-140	4	C-140	6	C-130	5	C-120	7	C-100	5	C-90	4	C-90	5	C-90	7	C-90	10	
68	C-140	4	C-140	5	C-130	4	C-120	6	C-100	5	C-100	6	C-90	4	C-90	6	C-90	9	
82	C-200	7	C-140	4	C-140	7	C-130	6	C-100	4	C-100	5	C-100	7	C-100	10	C-90	7	
100	C-200	6	C-200	8	C-140	6	C-130	5	C-120	6	C-100	5	C-100	6	C-100	8	C-90	6	
120	C-200	5	C-200	7	C-140	5	C-140	8	C-130	6	C-100	4	C-100	5	C-100	7	C-90	5	
150	C-200	4	C-200	5	C-140	4	C-140	7	C-130	5	C-130	7	C-100	4	C-100	5	C-90	4	
180	C-400	4	C-200	5	C-200	7	C-140	6	C-130	4	C-130	6	C-130	8	C-120	8	C-100	7	
200	C-400	4	C-200	4	C-200	6	C-140	5	C-140	8	C-130	5	C-130	7	C-120	7	C-100	6	
220	C-400	4	C-400	5	C-200	6	C-140	4	C-140	7	C-130	5	C-130	6	C-120	6	C-100	6	
270			C-400	4	C-200	5	C-200	8	C-140	6	C-130	4	C-130	5	C-120	5	C-100	5	
330					C-200	4	C-200	7	C-140	5	C-140	7	C-130	4	C-120	4	C-120	7	
390					C-400	4	C-200	6	C-140	4	C-140	6	C-140	7	C-140	10	C-120	6	
470					C-400	4	C-200	5	C-200	7	C-140	5	C-140	6	C-140	8	C-120	5	
560							C-200	4	C-200	6	C-140	4	C-140	5	C-140	7	C-120	4	
680							C-400	5	C-200	5	C-200	8	C-140	5	C-140	6	C-130	4	
820							C-400	4	C-400	6	C-200	6	C-140	4	C-140	5	C-140	7	
1000									C-400	5	C-200	5	C-200	7	C-140	4	C-140	6	
1200									C-400	4	C-200	4	C-200	6	C-200	7	C-140	5	
1500											C-400	5	C-200	5	C-200	6	C-140	4	
1800											C-400	4	C-400	6	C-200	5	C-200	8	
2200													C-400	5	C-200	4	C-200	6	
2700													C-400	4	C-400	5	C-200	5	
3300																	C-400	6	

Class II Dielectrics

Class I Dielectrics

CSM Series - Margin Capacitors



Margin caps have the topside electrode withdrawn from the edges in order to increase the distance between electrodes and dramatically decrease the possibilities of shorting when epoxy die-mounting. This style is also widely used for optical recognition-based assembly.

Increased margin sizes and special terminations are available for high power LC filter applications.

Description

- Margin capacitors can be customized to any sized square or rectangle

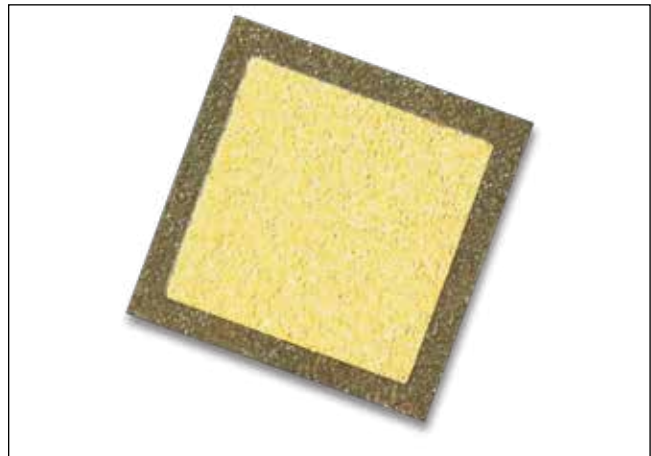

CSM Standard Capacitance Tolerance Codes

Class I Dielectrics: C-20 thru C-70				Class II Dielectrics: C-80 thru C-400			
Tolerance	Code	Tolerance	Code	Tolerance	Code	Tolerance	Code
±.50pF	D	±20%	M	-20% thru +80%	Z	±20%	M
±.25pF	C	±15%	L	-10% thru +40%	Y	±15%	L
±.10pF	B	±10%	K	-0% thru +100%	V	±10%	K
±.05pF	A	±5%	J	Guaranteed Min. Value	GMV	±5%	J
±.01pF	P	±3%	H				
		±2%	G				

CSM Chip Dimensions

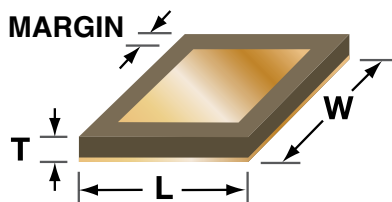

CSM Standard Dimensional Tolerances

Length & Width	L or W Tolerance	Margin Nominal	Thick.
≤.010	±.002	.001	±.0015
.011 thru .029	±.002	.002	
≥.030	±.003	.002	

All dimensions given are inches

CSM Electrode Configuration

Two electrodes



Ordering information - CSM Series - Margin Capacitors

CSM	90	10 x 10	x 5	G	2R7	M
Cap Style	Dielectric Type	Length x Width (mils)	Thickness (mils)	Metallization	Capacitance (pF)	Capacitance Tolerance
	See Class I and Class II tables (page 22)	See CSM Chip Dimensions (at right)	See CSM Selection Chart (at right)	G = Gold	First two digits represent significant figures and the last, the number of zeros to follow. When required, the letter "R" is used as a decimal point and the succeeding digits represent significant figures only. e.g.: 101 = 100pF, 1R6 = 1.6pF	See CSM Standard Capacitance Tolerance Codes (below)

Note: In cases where dimension cannot be exceeded, insert "M" to signify a Maximum dimension. The thickness tolerance is ±1.5 mils.
Example shown: Compex Series CSM, dielectric type C-90, .010" x .010" x .005", gold, 2.7pF, ±20% tolerance

Please contact factory to request free samples.

CSM Series - Margin Capacitors



CSM Selection Chart

Note: Selection Chart is for guidance only. All Complex parts are built to specific customer requirements.

Cap. (pF)	Capacitor Size in mils (mm)																	
	10 x 10 (.254 x .254)		12 x 12 (.305 x .305)		15 x 15 (.381 x .381)		20 x 20 (.508 x .508)		25 x 25 (.635 x .635)		30 x 30 (.762 x .762)		35 x 35 (.889 x .889)		40 x 40 (1.016 x 1.016)		50 x 50 (1.27 x 1.27)	
	Diel.	Thick.	Diel.	Thick.	Diel.	Thick.	Diel.	Thick.	Diel.	Thick.	Diel.	Thick.	Diel.	Thick.	Diel.	Thick.	Diel.	Thick.
0.04	C-30	4	C-30	4	C-30	5	C-20	5										
0.06	C-50	10	C-30	4	C-30	6	C-20	5	C-20	8	C-20	10						
0.08	C-50	7	C-50	10	C-30	5	C-30	10	C-20	6	C-20	8	C-20	11				
0.1	C-50	6	C-50	9	C-30	4	C-30	7	C-20	5	C-20	7	C-20	10				
0.2	C-58	4	C-50	4	C-50	5	C-30	4	C-30	5	C-30	7	C-20	4	C-20	5	C-20	10
0.3	C-70	6	C-58	5	C-50	4	C-50	8	C-30	4	C-30	5	C-30	7	C-20	4	C-20	6
0.4	C-70	4	C-58	4	C-58	6	C-50	6	C-50	10	C-30	4	C-30	5	C-30	7	C-20	5
0.5	C-80	5	C-70	4	C-58	5	C-50	4	C-50	7	C-50	10	C-30	4	C-30	6	C-30	10
0.6	C-80	5	C-70	5	C-58	4	C-50	4	C-50	6	C-50	10	C-30	4	C-30	5	C-30	7
0.8	C-80	5	C-80	5	C-70	5	C-58	6	C-50	5	C-50	7	C-50	10	C-30	4	C-30	6
1	C-80	4	C-80	5	C-70	4	C-58	5	C-50	4	C-50	6	C-50	8	C-50	10	C-30	5
1.2	C-90	6	C-80	5	C-80	7	C-58	4	C-58	7	C-50	5	C-50	7	C-50	10	C-30	4
1.5	C-90	7	C-80	4	C-80	6	C-70	6	C-58	6	C-58	8	C-50	6	C-50	7	C-50	15
1.8	C-90	6	C-80	4	C-80	5	C-70	5	C-58	5	C-58	7	C-50	5	C-50	7	C-50	10
2	C-90	6	C-90	8	C-80	4	C-70	5	C-58	5	C-58	6	C-50	4	C-50	6	C-50	10
2.2	C-90	5	C-90	7	C-80	4	C-80	7	C-70	7	C-58	6	C-50	4	C-50	5	C-50	10
2.7	C-90	5	C-90	6	C-80	4	C-80	6	C-70	6	C-58	6	C-58	8	C-50	5	C-50	8
3.3	C-100	6	C-90	6	C-90	8	C-80	5	C-70	5	C-58	4	C-58	6	C-58	7	C-50	6
3.9	C-100	5	C-90	5	C-90	7	C-80	4	C-70	4	C-70	6	C-58	5	C-58	6	C-50	5
4.7	C-100	5	C-90	5	C-90	7	C-80	4	C-80	6	C-70	5	C-58	4	C-58	5	C-58	8
5.6	C-100	5	C-100	6	C-90	5	C-80	4	C-80	5	C-70	4	C-70	6	C-58	5	C-58	7
6.8	C-120	5	C-100	6	C-90	5	C-90	8	C-80	5	C-80	7	C-70	5	C-70	7	C-58	6
8.2	C-120	4	C-100	5	C-90	4	C-90	7	C-80	4	C-80	6	C-70	4	C-70	5	C-58	5
10	C-120	5	C-100	4	C-100	6	C-90	6	C-80	4	C-80	5	C-80	6	C-70	5	C-58	4
12	C-120	5	C-120	6	C-100	5	C-90	5	C-90	8	C-80	4	C-80	6	C-70	4	C-70	6
15	C-120	4	C-120	5	C-100	5	C-90	5	C-90	7	C-80	4	C-80	5	C-80	6	C-70	5
18	C-130	4	C-130	6	C-120	7	C-100	7	C-90	5	C-90	9	C-80	4	C-80	5	C-70	4
20	C-140	5	C-130	5	C-120	6	C-100	6	C-90	5	C-90	8	C-80	4	C-80	5	C-70	4
22	C-140	7	C-130	4	C-120	5	C-100	6	C-90	5	C-90	7	C-90	10	C-80	4	C-80	6
27	C-140	6	C-130	4	C-130	5	C-100	5	C-90	4	C-90	6	C-90	8	C-80	4	C-80	5
33	C-140	5	C-140	6	C-130	4	C-100	4	C-100	6	C-90	5	C-90	7	C-90	9	C-80	5
39	C-140	4	C-140	5	C-130	4	C-120	6	C-100	6	C-90	4	C-90	6	C-90	8	C-80	4
47	C-200	8	C-140	5	C-140	6	C-120	5	C-100	5	C-100	7	C-90	5	C-90	7	C-90	11
56	C-200	6	C-140	4	C-140	5	C-130	5	C-100	4	C-100	6	C-90	4	C-90	6	C-90	9
68	C-200	5	C-200	8	C-140	5	C-130	4	C-120	6	C-100	5	C-90	4	C-90	5	C-90	7
82	C-400	6	C-200	6	C-140	4	C-130	4	C-120	5	C-100	4	C-100	6	C-90	4	C-90	6
100	C-400	5	C-200	6	C-140	4	C-140	6	C-130	5	C-120	6	C-100	5	C-100	7	C-90	5
120			C-200	5	C-200	6	C-140	5	C-130	4	C-130	6	C-100	4	C-100	5	C-90	4
150			C-200	6	C-200	6	C-140	4	C-140	7	C-130	5	C-130	7	C-100	4	C-100	7
180			C-400	5	C-200	5	C-140	4	C-140	6	C-130	4	C-130	6	C-100	4	C-100	6
200					C-400	5	C-140	4	C-140	6	C-130	4	C-130	5	C-120	6	C-100	5
220					C-400	5	C-200	8	C-140	5	C-130	4	C-130	5	C-120	5	C-100	5
270					C-400	5	C-200	6	C-140	4	C-140	7	C-130	4	C-130	6	C-100	4
330							C-200	5	C-140	4	C-140	5	C-140	7	C-130	5	C-120	6
390							C-200	5	C-200	6	C-140	5	C-140	6	C-130	4	C-120	5
470							C-200	4	C-200	6	C-140	4	C-140	5	C-140	7	C-130	5
560							C-400	5	C-400	6	C-140	4	C-140	5	C-140	6	C-130	4
680									C-400	6	C-200	6	C-140	4	C-140	5	C-140	8
820									C-400	5	C-200	5	C-200	8	C-140	4	C-140	7
1000											C-400	6	C-200	6	C-200	8	C-140	6
1200											C-400	5	C-200	5	C-200	7	C-140	5
1500													C-400	6	C-200	5	C-140	4
1800													C-400	5	C-400	6	C-200	7
2200														C-400	5	C-200	6	
2700														C-400	5	C-200	5	
3300																	C-400	5

Class II Dielectrics

Class I Dielectrics

CSB Series - Dual-Pad Capacitors



A single full electrode is provided on one side of the capacitor and split electrodes on the other side. This is a three-terminal capacitor which can be used as two capacitors with a common electrode, or as serially connected capacitors so that connections may be made on one side of the chip only (surface-mount). This design is often used in microstrip coupling to eliminate lead inductance and raise the self resonance frequency.

Description

- Capacitance: 0.06 picofarads and up
- Chip shapes: dual Pads with gap
- Gap widths: 5, 10, 15, 20 mil or custom

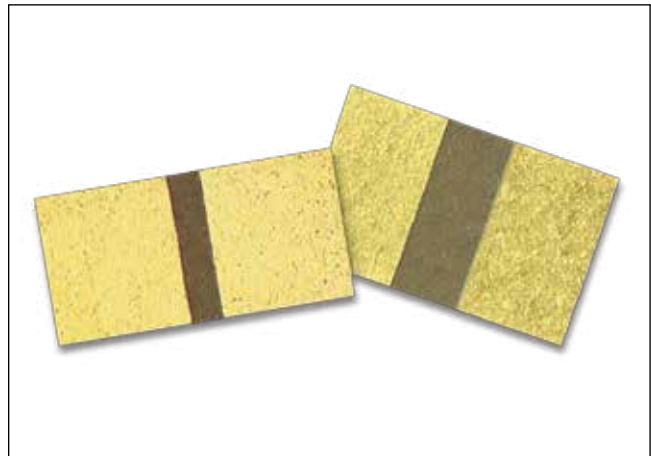

CSB Standard Capacitance Tolerance Codes

Class I Dielectrics: C-20 thru C-70		Class II Dielectrics: C-80 thru C-200			
Tolerance	Code	Tolerance	Code	Tolerance	Code
±20%	M	-10% thru +40%	Y	±20%	M
±15%	L	-20% thru +80%	Z	±15%	L
±10%	K	-0% thru +100%	V	±10%	K
±5%	J	Guaranteed Min. Value	GMV		

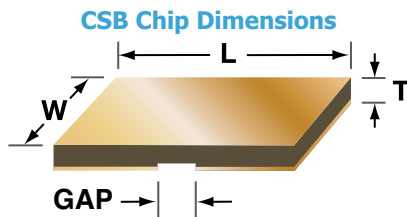

CSB Electrode Configuration

Split electrodes

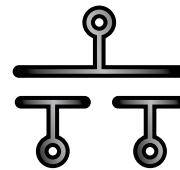

This component functions as two capacitors operating in series, each of which is twice the desired equivalent capacitance. Allow us to custom design for your application.

Ordering information - CSB Series - Dual-Pad Capacitors

CSB	100	50 x 20	x 7	10	G	120	M
Cap Style	Dielectric Type	Length x Width (mils)	Thickness (mils)	Gap (mils)	Metallization	Capacitance (pF)	Capacitance Tolerance
	See Class I and Class II tables (page 22)	See CSB Chip Dimensions (at right)	See CSB Selection Chart (at right)	5 or higher	G = Gold S = Silver Custom	First two digits represent significant figures and the last, the number of zeros to follow. When required, the letter "R" is used as a decimal point and the succeeding digits represent significant figures only. e.g.: 101 = 100pF, 1R6 = 1.6pF	See CSB Standard Capacitance Tolerance Codes (below)

Note: Standard dimensional tolerance for length and width is ±15% up to 20 mils. For dimensions greater than 20 mils, standard tolerance is ±10%. In cases where dimension cannot be exceeded, insert "M" to signify a Maximum dimension. The thickness tolerance is ±1.5 mils.

Example shown: Complex Series CSB, dielectric type C-100, .050" x .020" x .007", .01" gap, gold, 12pF, ±20% tolerance

Please contact factory to request free samples.

CSB Series - Dual-Pad Capacitors



CSB Selection Chart

Note: Selection Chart is for guidance only. All Complex parts are built to specific customer requirements.

Cap. (pF)	Capacitor Size in mils (mm)							
	20 x 10 (.508 x .254)		40 x 20 (1,016 x .508)		60 x 30 (1,524 x .762)		80 x 40 (2,032 x 1,016)	
	Diel.	Thick.	Diel.	Thick.	Diel.	Thick.	Diel.	Thick.
Class I Dielectrics								
0.06	C-50	6	C-30	6	C-20	6	C-20	8
0.08	C-50	4	C-30	4	C-20	4	C-20	7
0.1	C-58	7	C-50	15	C-30	8	C-20	5
0.2	C-70	6	C-50	7	C-30	4	C-30	7
0.3	C-80	8	C-50	5	C-50	10	C-30	4
0.4	C-80	6	C-58	7	C-50	8	C-50	15
0.5	C-80	5	C-58	6	C-50	7	C-50	10
0.6	C-80	4	C-58	5	C-50	6	C-50	9
0.8	C-90	11	C-70	6	C-50	4	C-50	7
1	C-90	9	C-70	5	C-58	7	C-50	6
1.2	C-90	7	C-70	4	C-58	6	C-50	5
1.5	C-90	6	C-80	7	C-58	5	C-58	8
1.8	C-90	5	C-80	6	C-58	4	C-58	6
2	C-90	4	C-80	5	C-58	4	C-58	6
2.2	C-90	4	C-80	5	C-70	6	C-58	5
2.7	C-100	7	C-80	4	C-70	5	C-58	4
3.3	C-100	6	C-90	11	C-70	4	C-70	6
3.9	C-100	5	C-90	9	C-80	7	C-70	5
4.7	C-100	4	C-90	8	C-80	5	C-70	4
5.6	C-120	6	C-90	6	C-80	5	C-80	7
6.8	C-120	5	C-90	5	C-80	4	C-80	6
8.2	C-130	5	C-90	4	C-90	11	C-80	5
10	C-130	4	C-100	7	C-90	9	C-80	4
12	C-140	8	C-100	6	C-90	7	C-90	11
15	C-140	6	C-100	5	C-90	6	C-90	9
18	C-140	5	C-100	4	C-90	5	C-90	8
20	C-140	5	C-120	7	C-90	4	C-90	7
22	C-140	4	C-120	6	C-90	4	C-90	6
27	C-200	8	C-120	5	C-100	7	C-90	5
33	C-200	6	C-130	5	C-100	6	C-100	9
39	C-200	5	C-130	4	C-100	5	C-100	8
47	C-400	6	C-140	8	C-100	4	C-100	6
56	C-400	5	C-140	7	C-120	6	C-100	5
68	C-400	4	C-140	5	C-120	5	C-120	8
82			C-140	4	C-130	5	C-130	8
100			C-200	8	C-130	4	C-130	7
120			C-200	7	C-140	8	C-130	6
150			C-200	5	C-140	6	C-130	5
180			C-200	5	C-140	5	C-140	8
200			C-400	6	C-140	5	C-140	7
220			C-400	5	C-200	9	C-140	7
270			C-400	4	C-200	8	C-140	6
330					C-200	6	C-140	5
390					C-200	5	C-200	9
470					C-400	6	C-200	7
560					C-400	5	C-200	6
680					C-400	4	C-200	5
820							C-400	6
1000							C-400	5
1200							C-400	4

Class II Dielectrics

CR/CM Series - Row Capacitors



Row Capacitors are used where arrays of capacitors (not necessarily identical) are needed, usually for decoupling/bypass of GaAs integrated circuits. Standard arrays can contain up to 10 capacitors from 0.04pF on up. Typical overall dimensions range from 20 x 10 mils on up. Parts can be fully customized to meet the requirements of your application to provide the shortest lead length possible.

Description

Row caps (CR) are also available with margins (CM) surrounding the edges to help prevent epoxy shorts and aid optical recognition systems.

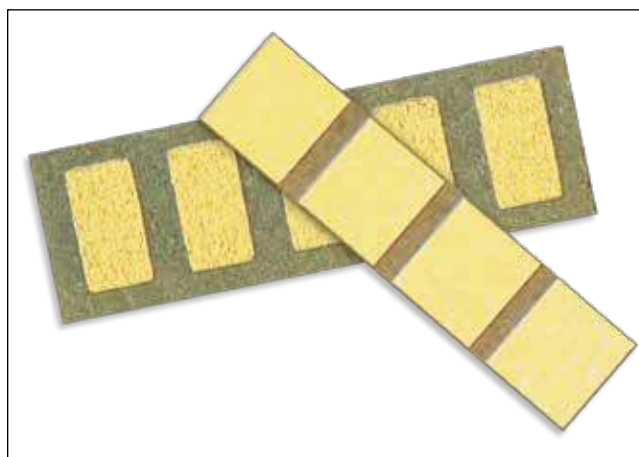

CR/CM Standard Capacitance Tolerance Codes

Class I Dielectrics: C-20 thru C-70		Class II Dielectrics: C-80 thru C-400			
Tolerance	Code	Tolerance	Code	Tolerance	Code
±20%	M	-10% thru +40%	Y	±20%	M
±15%	L	-20% thru +80%	Z	±15%	L
±10%	K	-0% thru +100%	V	±10%	K
		Guaranteed Min. Value	GMV		

CR6 Chip Dimensions

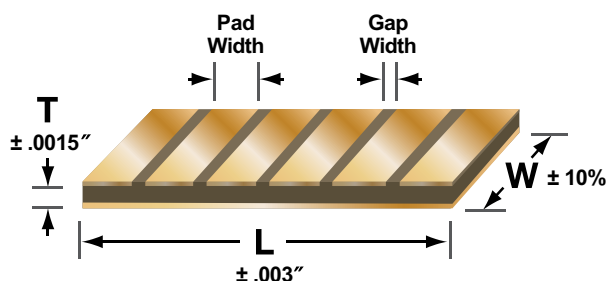

CR/CM Electrode Configuration

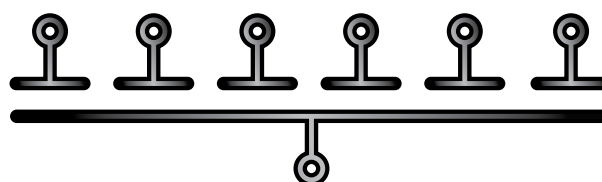

Ordering information - CR/CM Series - Row Capacitors

CR	6	130	105 x 25	x 4	5	G	101	Z
Cap Style	Number of Caps	Dielectric Type	Length x Width (mils)	Thickness (mils)	Gap (mils)	Metallization	Capacitance (pF)	Capacitance Tolerance
CR = Row CM = Margin		See Class I and Class II tables (page 22)	See CR/CM Chip Dimensions (at right)	See CR/CM Selection Chart (at right)		G = Gold Custom	First two digits represent significant figures and the last, the number of zeros to follow. When required, the letter "R" is used as a decimal point and the succeeding digits represent significant figures only. e.g.: 101 = 100pF, 1R6 = 1.6pF	See CR/CM Standard Capacitance Tolerance Codes (below)

Note: Example shown: Complex Series CR, dielectric type C-130, .105" x .025", gold, 100pF, +80 to -20% tolerance, 6 cap. chip

Please contact factory to request free samples.

CR/CM Series - Row Capacitors



CR/CM Selection Chart

Note: Selection Chart is for guidance only. The square area and capacitance parameters are for a single pad.
All Complex parts are built to specific customer requirements.

Cap. (pF)	Capacitor Size in mils (mm)																			
	10 x 10 (.254 x .254)		12 x 12 (.305 x .305)		15 x 15 (.381 x .381)		20 x 20 (.508 x .508)		25 x 25 (.635 x .635)		30 x 30 (.762 x .762)		35 x 35 (.889 x .889)		40 x 40 (1.016 x 1.016)		50 x 50 (1.27 x 1.27)			
	Diel.	Thick.	Diel.	Thick.	Diel.	Thick.	Diel.	Thick.	Diel.	Thick.	Diel.	Thick.	Diel.	Thick.	Diel.	Thick.	Diel.	Thick.		
0.04	C-30	5	C-30	6	C-30	10													Class I Dielectrics	
0.06	C-30	4	C-30	5	C-30	8	C-20	5	C-20	10										
0.08	C-50	10	C-30	4	C-30	6	C-30	10	C-20	7	C-20	9								
0.1	C-50	8	C-50	11	C-30	5	C-30	9	C-20	5	C-20	7	C-20	10						
0.2	C-50	5	C-50	7	C-50	10	C-30	4	C-30	7	C-30	10	C-20	5	C-20	7	C-20	10		
0.3	C-58	6	C-50	4	C-50	6	C-50	11	C-30	4	C-30	7	C-30	9	C-20	5	C-20	7		
0.4	C-58	5	C-58	7	C-50	5	C-50	9	C-50	15	C-30	5	C-30	7	C-30	9	C-20	5		
0.5	C-58	4	C-58	5	C-50	4	C-50	7	C-50	11	C-30	5	C-30	5	C-30	7	C-20	4		
0.6	C-70	6	C-58	5	C-58	7	C-50	6	C-50	10	C-50	15	C-30	4	C-30	6	C-30	9		
0.8	C-80	8	C-70	6	C-58	5	C-50	5	C-50	7	C-50	10	C-50	15	C-30	4	C-30	7		
1	C-80	7	C-70	5	C-58	4	C-58	7	C-50	6	C-50	8	C-50	10	C-30	4	C-30	5		
1.2	C-80	6	C-70	4	C-58	4	C-58	6	C-50	5	C-50	7	C-50	9	C-30	3	C-30	5		
1.5	C-80	5	C-80	7	C-70	5	C-58	5	C-50	4	C-50	6	C-50	7	C-50	10	C-30	4		
1.8	C-80	4	C-80	5	C-70	4	C-58	4	C-58	6	C-50	5	C-50	6	C-50	8	C-50	11		
2	C-80	4	C-80	5	C-70	4	C-70	7	C-58	6	C-50	4	C-50	5	C-50	7	C-50	11		
2.2	C-90	4	C-80	5	C-70	4	C-70	6	C-58	5	C-58	7	C-50	5	C-50	7	C-50	10		
2.7	C-90	8	C-80	4	C-80	6	C-70	5	C-58	4	C-58	6	C-50	4	C-50	5	C-50	8		
3.3	C-90	7	C-90	10	C-80	5	C-70	4	C-70	6	C-58	5	C-58	7	C-50	4	C-50	7		
3.9	C-90	6	C-90	9	C-80	4	C-80	7	C-70	5	C-58	4	C-58	6	C-58	8	C-50	6		
4.7	C-90	5	C-90	7	C-90	11	C-80	6	C-70	4	C-70	6	C-58	5	C-58	6	C-50	5		
5.6	C-90	4	C-90	6	C-90	10	C-80	5	C-80	7	C-70	5	C-58	4	C-58	5	C-50	4		
6.8	C-90	4	C-90	5	C-90	8	C-80	4	C-80	6	C-70	5	C-70	6	C-58	4	C-58	7		
8.2	C-100	6	C-90	4	C-90	7	C-80	4	C-80	5	C-70	4	C-70	5	C-70	7	C-70	10		
10	C-100	5	C-90	4	C-90	5	C-90	9	C-80	4	C-80	6	C-70	4	C-70	5	C-70	8		
12	C-100	4	C-100	6	C-90	5	C-90	8	C-90	11	C-80	5	C-80	7	C-70	4	C-70	7		
15	C-120	6	C-100	5	C-90	4	C-90	6	C-90	10	C-80	4	C-80	6	C-80	7	C-70	6		
18	C-120	5	C-100	4	C-100	6	C-90	5	C-90	8	C-90	11	C-80	4	C-80	6	C-70	5		
20	C-120	5	C-100	4	C-100	6	C-90	5	C-90	8	C-90	11	C-80	4	C-80	5	C-70	4		
22	C-120	4	C-120	6	C-100	5	C-90	4	C-90	7	C-90	9	C-80	4	C-80	5	C-70	4		
27	C-120	4	C-120	5	C-100	4	C-90	4	C-90	6	C-90	8	C-80	3	C-80	4	C-80	6		
33	C-130	4	C-120	4	C-120	6	C-100	6	C-90	5	C-90	6	C-90	11	C-80	4	C-80	5		
39	C-140	6	C-120	4	C-120	5	C-100	5	C-90	4	C-90	5	C-90	7	C-90	10	C-80	4		
47	C-140	5	C-140	7	C-120	5	C-100	4	C-100	6	C-90	5	C-90	6	C-90	8	C-80	4		
56	C-140	4	C-140	6	C-130	5	C-120	7	C-100	5	C-90	4	C-90	5	C-90	7	C-90	10		
68	C-140	4	C-140	5	C-130	4	C-120	6	C-100	5	C-100	6	C-90	4	C-90	6	C-90	9		
82	C-200	7	C-140	4	C-140	7	C-130	6	C-100	4	C-100	5	C-100	7	C-100	10	C-90	7		
100	C-200	6	C-200	8	C-140	6	C-130	5	C-120	6	C-100	5	C-100	6	C-100	8	C-90	6		
120	C-200	5	C-200	7	C-140	5	C-140	8	C-130	6	C-100	4	C-100	5	C-100	7	C-90	5		
150	C-200	4	C-200	5	C-140	4	C-140	7	C-130	5	C-130	7	C-100	4	C-100	5	C-90	4		
180	C-400	4	C-200	5	C-200	7	C-140	6	C-130	4	C-130	6	C-130	8	C-120	8	C-100	7		
200	C-400	4	C-200	4	C-200	6	C-140	5	C-140	8	C-130	5	C-130	7	C-120	7	C-100	6		
220	C-400	4	C-400	5	C-200	6	C-140	4	C-140	7	C-130	5	C-130	6	C-120	6	C-100	6		
270			C-400	4	C-200	5	C-200	8	C-140	6	C-130	4	C-130	5	C-120	5	C-100	5		
330					C-200	4	C-200	7	C-140	5	C-140	7	C-130	4	C-120	4	C-120	7		
390					C-400	4	C-200	6	C-140	4	C-140	6	C-140	7	C-140	10	C-120	6		
470					C-400	4	C-200	5	C-200	7	C-140	5	C-140	6	C-140	8	C-120	5		
560							C-200	4	C-200	6	C-140	4	C-140	5	C-140	7	C-120	4		
680							C-400	5	C-200	5	C-200	8	C-140	5	C-140	6	C-130	4		
820							C-400	4	C-400	6	C-200	6	C-140	4	C-140	5	C-140	7		
1000									C-400	5	C-200	5	C-200	7	C-140	4	C-140	6		
1200									C-400	4	C-200	4	C-200	6	C-200	7	C-140	5		
1500											C-400	5	C-200	5	C-200	6	C-140	4		
1800											C-400	4	C-400	6	C-200	5	C-200	8		
2200													C-400	5	C-200	4	C-200	6		
2700													C-400	4	C-400	5	C-200	5		
3300																	C-400	6		

High-K Ceramic Substrates & Plates

High-K substrates are used for circuit miniaturization.

DLI offers complete fabrication services!

Case Sizes and Tolerances

For custom sizes please contact the sales office.

Case Size (Inches)	Length (Inches)	Width (Inches)	Tolerance	
			Plates (H) ± (Inches)	Substrates (S) ± (Inches)
10	1.000	1.000	Substrates Only	.002
15	1.000	1.500	.050	.002
20	2.000	2.000	.050	.002
25	2.500	2.500	.050	.002
30	3.000	3.000	.050	.002
40	4.000	4.000	.050	.002

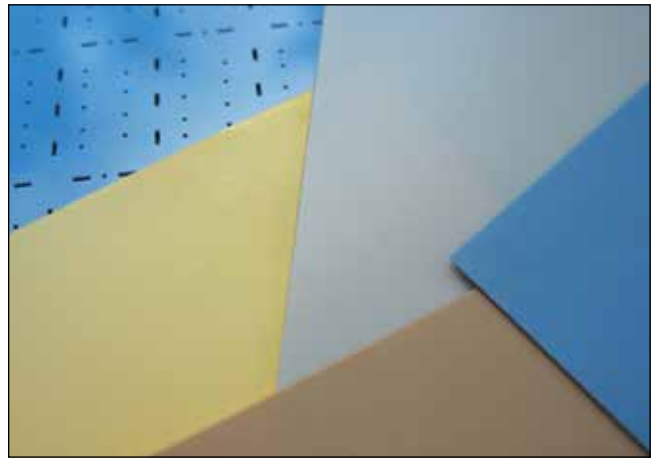

Material Specifications

Material Code	Relative ϵ_r^* @ 5 GHz	TCC+Loss ppm/°C	Coefficient of Tangent* % Max	Thermal Thermal Expansion ppm/°K	Conductivity W/m-°K
QZ	3.82 (@ 1MHz)	Fused Quartz	0.0015 (@ 1MHz) 0.033 (@ 24 GHz)	0.55	1.28
AG	8.85 ± 0.35 (@ 1MHz)	Aluminum Nitride	0.10	4.6	140-180
PI	9.9 ± 0.15 (@ 1MHz)	Alumina 99.6%	0.01	6.5 - 7.5	27
PG	12.5 ± 0.5	P22 ± 30	0.02	7.6	—
AH	20 ± 0.5	P90 ± 20	0.02	9.6	1.56
NA	23 ± 1	N30 ± 15	0.03	10.1	1.56
CF	25 ± 2	0 ± 15	0.15	9.0	1.56
CD	38 ± 1	N20 ± 15	0.04	5.8	1.59
CG	67 ± 3	0 ± 30	0.10	9.0	1.59
NR	152 ± 5	N1500 ± 500	0.06	10.0	2.72

*Unless otherwise specified K dielectric measurement at approximately 5 GHz. †For the temperature range -55 to 125°C.

Surface Finish

Code	Roughness R_a	Material Process
X	>50 μ in.	As-Fired
Y	20 μ in.	Machined
Z	<5 μ in.	Polished
S	Special - Drawing required.	

Metallization

Code	Description
X	No Metallization
M	300 Angstroms TiW, 100 μ in. min. Au
N	300 Angstroms TiW, 50 μ in. min. NiV, 100 μ in. min. Au
P	75 μ in. min. Nickel, 100 μ in. min. Au
L	Top 50 Ohms/sq. TaN, 300 Angstroms TiW, 100 μ in. min Au. Bottom Side 300 Angstroms TiW, 100 μ in. min. Au
E	Metallized and etched per Customer drawing
T	300 Angstroms min. TiW, 50 μ in. min. NiV, 300 μ in. min. Au-Sn
D	SPECIAL, Customer Drawing Required.

Screening Options

Test Code	Test/Inspection	Sample Size	Description
X	Visual Mechanical	100%	Verify that the required area is available and continuous (Broken corners allowable).
K	Visual Mechanical	100%	Verify that the required area is available and continuous (Broken corners allowable).
	Kent Test	10% of lot	K and Loss.
D	Customer Defined		Customer Drawing Required!

Ordering information - Thin Film - High-K Ceramic Substrates & Plates

S	20	CG	250	D	Z	N	X
Product	Case Size	Material	Thickness	Thickness Tolerance	Surface Finish	Metallization	Test Level
S = Substrate H = Plate	10 15 20 25 30 40	See material table above.	100 = .010" 155 = .0155" 250 = .025" Thickness Code. A three digit code representing the thickness in mils. Examples: Code 100 = .010", Code 155 = .0155", Code 250 = .025" Please consult with an applications engineer for thicknesses < .010"	D = ±.0005 E = ±.001 Thickness Tolerance Codes D = ± .0005 – Machined or Polished E = ± .001 – Standard	X Y Z S See table above.	See table above.	X K D See test level definitions on page 5.

Heatsinks

- Heatsinks are fully metallized on all sides and are used to dissipate and absorb heat
- Heatsinks allow for high thermal conductivity and are electrically conductive (DC short)
- Typically used with LED's or laser diodes

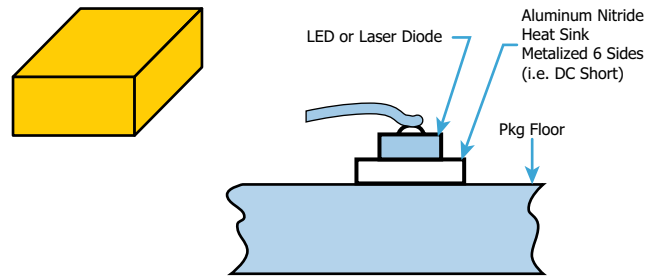

Standoffs

- A Standoff is much like a Heatsink however it is typically metallized on only the top and bottom surfaces
- Each device is custom tailored to the customer's specifications and is typically used with LED's or Photo Diodes (works as a photo detector, light is allowed in through fibers)

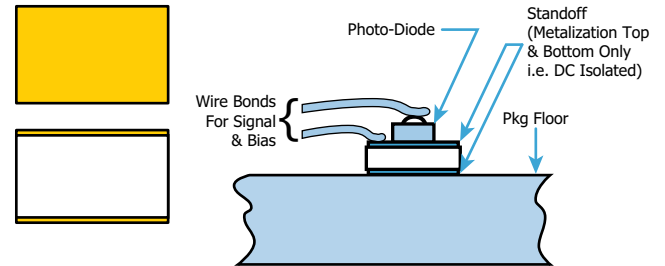

Submounts

- Submounts are ceramic LED package bases which minimize thermal resistance between LED junctions and adjacent components
- By reducing junction temperatures, an LED will produce increased efficiency, brightness, color and reliability
- Each device is custom tailored to the customer's specifications

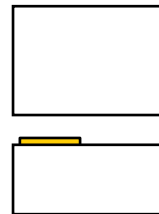

Material Specifications

Material Code	Relative ϵ_r^* @ 5 GHz	TCC+Loss ppm/°C	Coefficient of Tangent* % Max	Thermal Thermal Expansion ppm/°K	Conductivity W/m-°K
AG	8.85 ± 0.35 (@ 1MHz)	Aluminum Nitride	0.10	4.6	140-180
PI	9.9 ± 0.15 (@ 1MHz)	Alumina 99.6%	0.01	6.5 - 7.5	27

*Unless otherwise specified K dielectric measurement at approximately 5 GHz. †For the temperature range -55 to 125°C. **Material only provided metallized.

Surface Finish

Code	Roughness R_a	Material Process
X	>50 μ in.	As-Fired
Y	20 μ in.	Machined
Z	<5 μ in.	Polished
S	Special	Drawing required

Metallization

Code	Description
M	300 Angstroms TiW, 100 μ in. min. Au
P	75 μ in. min. Nickel, 100 μ in. min. Au
E	Metallized and etched per Customer drawing
T	300 Angstroms min. TiW, 50 μ in. min. NiV, 300 μ in. min. Au-Sn
D	SPECIAL, DLI Design per Customer Requirements

SBT Series - Submounts

Submount materials include quartz, alumina, aluminum nitride, kovar and beryllium oxide.

Applications include: heat sinks, standoffs, height matching, bonding pads, and jumpers.

Custom sizes, patterns and shapes available to your design specifications in thicknesses from 3 to 100 mils and beyond.

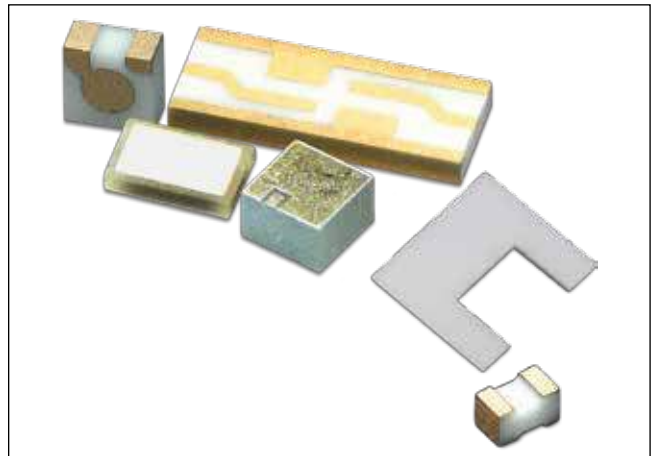

Submount Material Properties Chart

	Quartz	Alumina	AlN	Kovar	BeO	Si
Compex Material Code	C-20	C-30/35	C-28	KVR	C-25	C-22
Coefficient of Thermal Expansion (ppm/°C)	6	6.7	4.6	5.86	7.5	0.56
Thermal Conductivity (W/m-K)	1.6	26	170	17.3	270	1.38 (SiO ₂)

Ordering information - SBT Series - Submounts

SBT	28	20 x 20	x 6	G	S	5
Cap Style	Material	Length x Width (mils)	Thickness (mils)	Metallization	Cut to Size	Thickness Tolerance
SBT = Edge-to-edge plated or bare CSX = Custom patterned	See Submount Material Properties Chart above		3 to +100 mils	G = Gold B = Bare Custom		(only utilized if <.001"; figure represents tenths of a mil)

Note: Standard dimensional tolerance is .001" for length, width, and thickness. Tighter Thickness tolerances down to .0002" are available.

Example: Compex Series SBT, dielectric type C-28, .020" x .020" x .006", gold, cut to size, .0005" thickness tolerance

Kits available for design development

Please contact factory to request free samples.

MST Series - Mounting Shorts

Alumina mounting shorts (or Aluminum Nitride for improved thermal properties), with metallization on the top, bottom and two of four sides, allow placement of a wirebond anywhere in the circuit, replacing the need for gold terminations on the substrate. They also can be used to raise the ground plane, reducing lead length for reduced inductance for high-speed/frequency applications, or to dissipate heat from under an IC or laser chip.

Description

- Instant bonding pads
- Fully conductive
- Height matching
- Replaces moly-tabs
- Any size available, as small as .003" X .003"

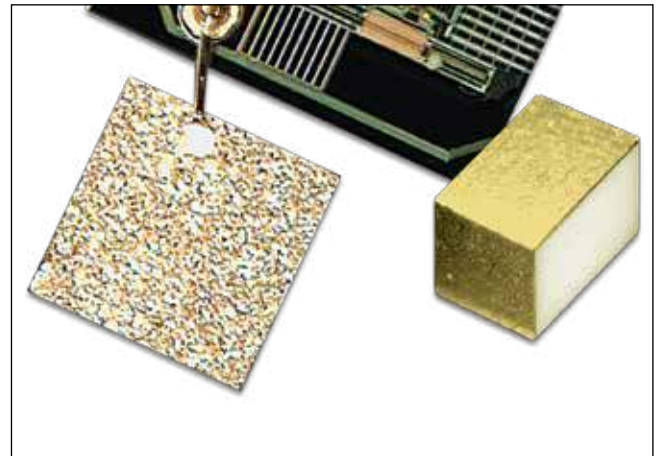

MST Chip Dimensions

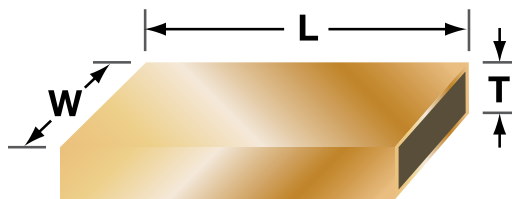

Dimensional Tolerance: Standard is .001" for length, width and thickness. Tighter tolerances down to .0003" are available for thickness .0005" and greater.

For <.0005" consult factory for available tolerances.

Wirebond



Raised Plane



Our ceramic mounting shorts are excellent replacements for kovar and moly-tabs. These ceramic shorts have a much sharper edge and are flat stable bases for mounting semiconductors.

Ordering information - MST Series - Mounting Shorts

MST	30	25	x 20	x 6	G	S	5
Cap Style	Material	Length (mils)	Width (unmetallized side) (mils)	Thickness (mils)	Metallization	Cut to Size	Thickness Tolerance
				3 to +100 mils	G = Gold Custom		(only utilized if <.001"; figure represents tenths of a mil)

Example Shown: Compex Series MST, dielectric type C-30, .025" x .020" x .006", gold, cut to size, .0005" thickness tolerance

Kits available for design development

Milli-Cap® - Ideal SMT Capacitor

Features

- 0201, 0402 and 0602 footprints
- Low Loss High Q part
- Very Low Series Inductance
- Ultra High Series Resonance
- Matches typical 50Ω line widths
- Behaves like an Ideal Capacitor
- Single piece construction
- Orientation insensitive

Functional Applications

- Test Equipment, Photonics, SONET, TOSA/ROSA, High Speed Data
- Broadband Microwave/Millimeter Wave
- Transimpedance Amplifiers

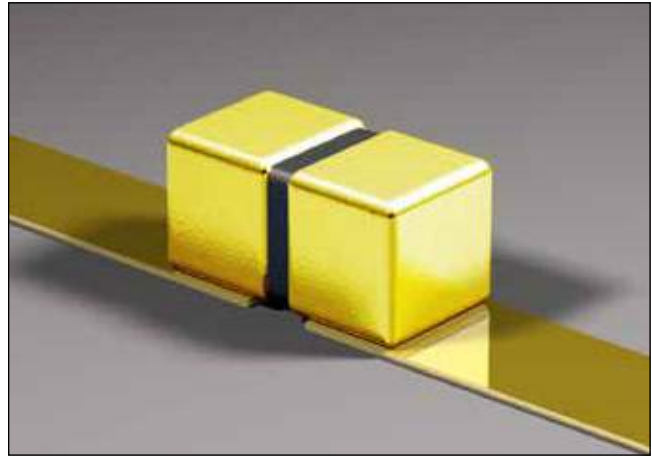

Specification - Milli-Cap®

Electrical	
Temperature Coefficient of Capacitance	Values as per electrical characteristics table
Milli-Cap® Metallization	7.5μ" Au over 50μ" Ni
Capacitance Range	0.5pF to 82pF
Maximum Assembly Process Temperature	250°C

P21

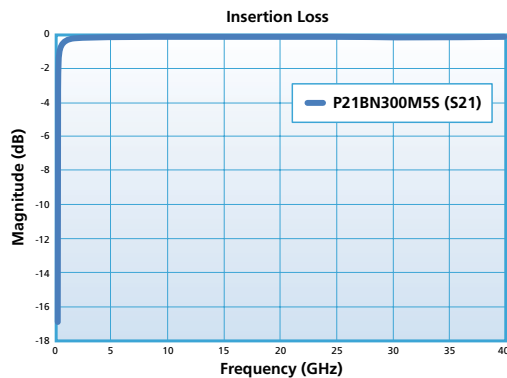

P62

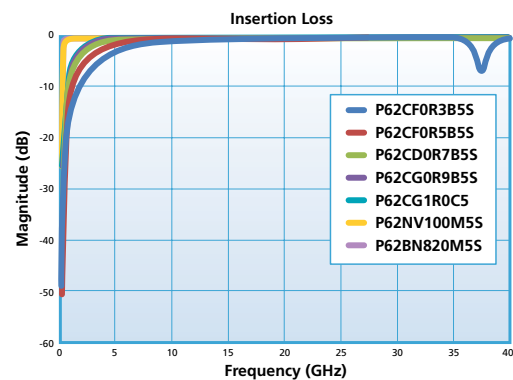

P42

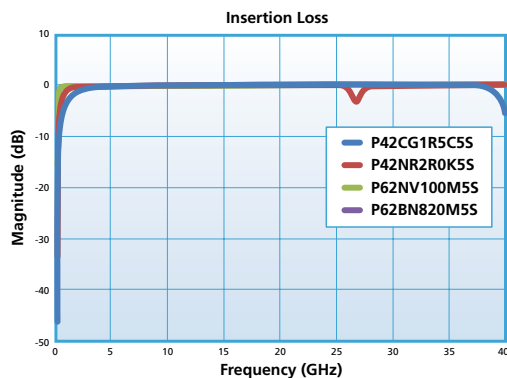

Electrical characteristics - Milli-Cap®

Part Number	Value (pF)	Voltage Rating	TCC	Dissipation Factor (Max)	Insulation Resistance (Min)	Frequency Range
P21BN300M5S	30	50	± 15%	3.5%	10 ⁵ MΩ	20MHz – 40GHz
P42BN820M5S	82	50	± 15%	3.5%	10 ⁵ MΩ	20MHz – 40GHz
P42NR2R0K5S	2	50	N1500 ± 500ppm/°C	0.25%	10 ⁶ MΩ	4GHz – 20GHz
P42CG1R5C5S	1.5	50	0 ± 30ppm/°C	0.7%	10 ⁶ MΩ	8GHz – 32GHz
P62BN820M5S	82	50	± 15%	3.5%	10 ⁵ MΩ	20MHz – 40GHz
P62NV100M5S	10	50	N4700 ± 1000ppm/°C	1.2%	10 ⁶ MΩ	4GHz – 20GHz
P62CG1R0C5S	1	50	0 ± 30ppm/°C	0.7%	10 ⁶ MΩ	18GHz – 40GHz
P62CD0R7B5S	0.7	50	N20 ± 15ppm/°C	0.15%	10 ⁶ MΩ	20GHz – 40GHz
P62CF0R5B5S	0.5	50	0 ± 15 ppm/°C	0.6%	10 ⁶ MΩ	28GHz – 40GHz

Dimensional specifications - Milli-Cap®

Case size	Milli-Cap®		
	Length	Width	Thickness
P21 (0201)	0.020" ± 0.004"	0.012" ± 0.002"	0.010" ± 0.002"
P42 (0402)	0.038" ± 0.004"	0.020" ± 0.002"	0.020" ± 0.002"
P62 (0602)	0.058" ± 0.004"	0.020" ± 0.002"	0.020" ± 0.002"

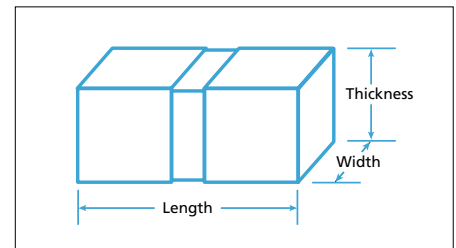

Attachment methods - Milli-Cap®

Recommended attachment to soft or hard substrate using Conductive Epoxy

1. Place a single drop of conductive epoxy onto each micro strip as illustrated; the edge of the epoxy shall be at least .003"-.004" back from the edge of the trace to prevent filling the gap with epoxy.
2. Centering the termination gap of the capacitor within the gap in the micro strip, press with careful, even pressure onto the micro strip ensuring the terminations make good contact with the epoxy drops.

3. Cure according to the epoxy manufacturer's preferred schedule, typically 125°C to 150°C max.

4. After curing, inspect joint for epoxy shorts across the termination and micro strip gaps that would cause a short across the cap.

Isopropanol and Methanol are both safe to use to pre clean Milli-Caps®.

Isopropanol, and Methanol are not to be used after mounting with conductive epoxy as they act as a solvent!

Recommended attachment to soft or hard substrate using Solder

1. Place a single drop of solder paste onto each micro strip as illustrated; the edge of the solder shall be at least .001"-.002" back from the edge of the trace to prevent filling the gap with solder.
2. Centering the termination gap of the capacitor within the gap in the micro strip, press with careful, even pressure onto the micro strip ensuring the terminations make good contact with the drops of solder paste.

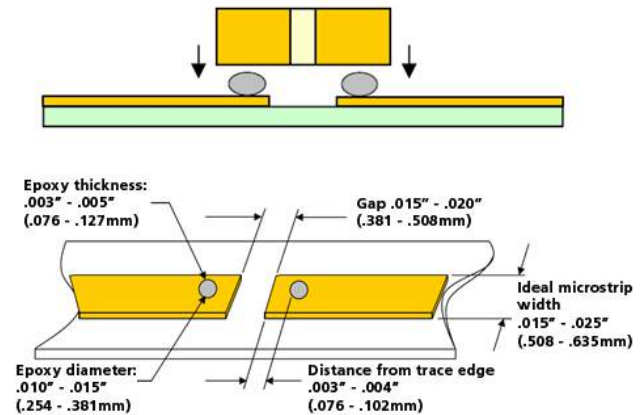

3. Reflow according to the solder manufacturer's preferred profile, ensuring the reflow temperature does not exceed 250°C.
4. After the reflow step is completed, inspect joint for voids or excess flux and non-reflowed solder balls that can degrade performance or cause shorts across the gaps. Proper cleaning after the reflow process is crucial to avoiding performance degradation and discovering poor solder joints.

Isopropanol and Methanol are both safe to use with soldered Milli-Caps®.

Features

- X7R temperature and voltage stability
- Resonance free DC blocking to >40GHz
- SMT by solder or epoxy bonding
- Low frequency stability over temperature
- Very low series inductance
- 0201, 0402 and 0602 footprints

Functional Applications

- Test Equipment, Photonics, SONET, TOSA/ROSA, High Speed Data
- Broadband Microwave/Millimeter Wave
- Transimpedance Amplifiers

Benefits

- Eliminates wire-bonding
- Coplanar waveguide
- Low insertion loss

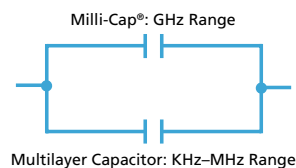
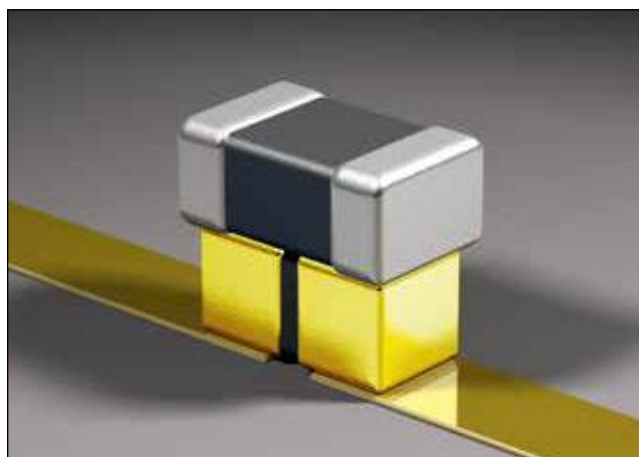

Specification

Electrical	
Temperature Coefficient of Capacitance	X5R: -55°C to +85°C (TCC ± 15%) X7R: -55°C to +125°C (TCC ± 15%)
Capacitance Range	1.5nF to 220nF
Maximum Assembly Process Temperature	250°C

Insertion Loss

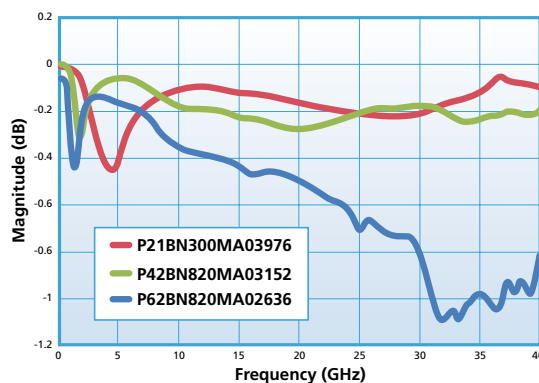

Electrical characteristics - Opti-Cap®

Part Number	Capacitance		Voltage Rating	TCC	DF (Max)	IR (Min)	Frequency Range
	MLC	Milli-Cap®					
P21BN300MA04733	100nF	30pF	10V	X5R	3.5%	>10 ² MΩ	16KHz - >40GHz
P21BN300MA04282	22nF	30pF					
P21BN300MA03976	10nF	30pF					
P21BN300MA04678	1.5nF	30pF	25V	X7R	3.5%	>10 ² MΩ	
P42BN820MA03152	220nF	82pF	10V	X5R	3.5%	>10 ² MΩ	
P42BN820MA04679	22nF	82pF	50V	X7R	3.5%	>10 ² MΩ	
P62BN820MA02636	100nF	82pF	25V	X7R	3.5%	>10 ² MΩ	

Dimensional specifications - Opti-Cap®

Case size	Milli-Cap®			MLC		
	Length	Width	Thickness	Length	Width	Thickness
P21 (0201)	0.020" ± 0.004"	0.012" ± 0.002"	0.010" ± 0.002"	0.022 ± 0.002"	0.010 ± 0.001"	0.010 ± 0.002"
P42 (0402)	0.038" ± 0.004"	0.020" ± 0.002"	0.020" ± 0.002"	0.040 ± 0.002"	0.020 ± 0.002"	0.020 ± 0.002"
P62 (0602)	0.058" ± 0.004"	0.020" ± 0.002"	0.020" ± 0.002"	0.067 ± 0.004"	0.031 ± 0.004"	0.031 ± 0.005"

Attachment methods - Opti-Cap®

Recommended attachment to soft or hard substrate using Conductive Epoxy

1. Place a single drop of conductive epoxy onto each micro strip as illustrated; the edge of the epoxy shall be at least .003"-.004" back from the edge of the trace to prevent filling the gap with epoxy.
2. Centering the termination gap of the capacitor within the gap in the micro strip, press with careful, even pressure onto the micro strip ensuring the terminations make good contact with the epoxy drops.
3. Cure according to the epoxy manufacturer's preferred schedule, typically 125°C to 150°C max.
4. After curing, inspect joint for epoxy shorts across the termination and micro strip gaps that would cause a short across the cap.

Isopropanol and Methanol are both safe to use to pre clean Opti-Caps®.

Isopropanol, and Methanol are not to be used after mounting with conductive epoxy as they act as a solvent!

Recommended attachment to soft or hard substrate using Solder

1. Place a single drop of solder paste onto each micro strip as illustrated; the edge of the solder shall be at least .001"-.002" back from the edge of the trace to prevent filling the gap with solder.
2. Centering the termination gap of the capacitor within the gap in the micro strip, press with careful, even pressure onto the micro strip ensuring the terminations make good contact with the drops of solder paste.

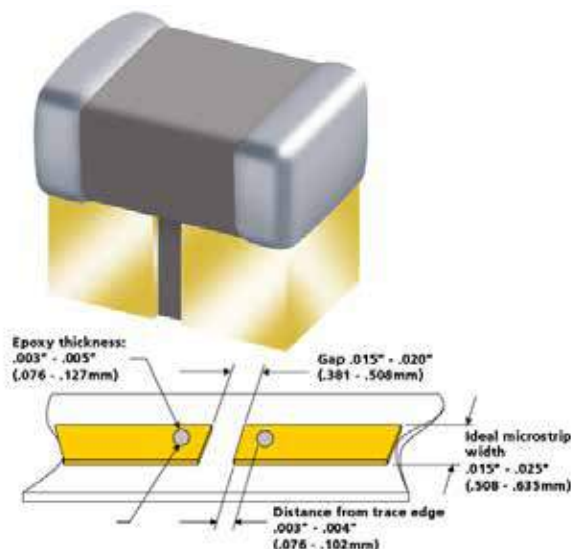

3. Reflow according to the solder manufacturer's preferred profile, ensuring the reflow temperature does not exceed 250°C.

4. After the reflow step is completed, inspect joint for voids or excess flux and non-reflowed solder balls that can degrade performance or cause shorts across the gaps.

Proper cleaning after the reflow process is crucial to avoiding performance degradation and discovering poor solder joints.

Isopropanol and Methanol are both safe to use with soldered Opti-Caps®.

PX Series - Broadband Blocking Device

Features

- X7R temperature and voltage stability
- Low frequency Stability
- Low insertion Loss
- Solder or Epoxy attachment

Functional Applications

- Broadband Microwave/Millimeter Wave
- Test Equipment
- ROSA/TOSA
- SONENT

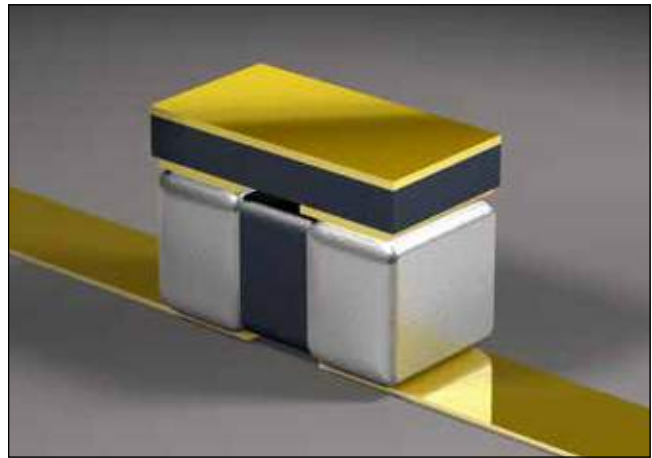

Specification - PX Series

Electrical	
Temperature Coefficient of Capacitance	SLC: 120pF Guaranteed Minimum Value (GMV) MLC: 100nF ±10%
Voltage	16WVDC
Dissipation Factor	3.0% @ 1MHz
Insulation Resistance	> 10 ³ MΩ
Assembly Process Temperature	250°C
Part Number	Metallization
PX42UX104KCZX PX42UX104KCSX	Sn (200μ") / Ni (150-250μ") Au (5-15μ") / Ni (150-250μ")
Packaging	(T) Tape & Reel - (W) Waffle Pack

Mechanical	
Pressure force	>2.5N (min)

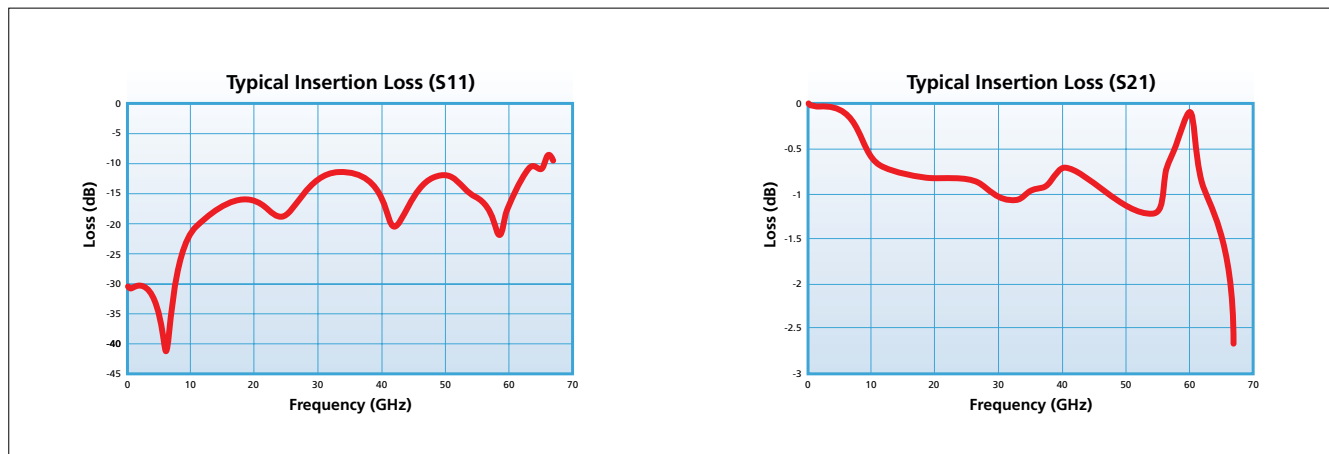

Dimensions - PX Series Broadband Blocking Device

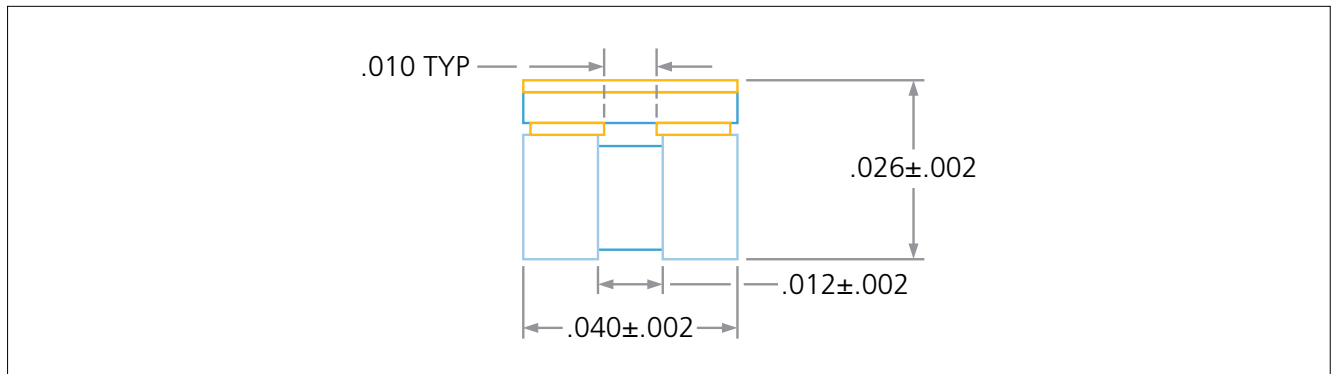

Attachment Method - PX Series - Broadband Blocking Device

Recommended attachment to soft or hard substrate using Solder: Recommended Micro Strip Layout:

1. Place a single drop of solder paste onto each micro-strip as illustrated; the edge of the solder shall be at least .001"-.002" back from the edge of the trace to prevent filling the gap with solder.
2. Centering the termination gap of the capacitor within the gap in the micro strip, press with careful, even pressure onto the micro strip ensuring the terminations make good contact with the drops of solder paste.
3. Reflow according to the solder manufacturer's preferred profile, ensuring the reflow temperature does not exceed 260°C.
4. After the reflow step is completed, inspect joint for voids or excess flux and non-reflowed solder balls that can degrade performance or cause shorts across the gaps. Proper cleaning after the reflow process is crucial to avoiding performance degradation and discovering poor solder joints.

Mounting:

The part is designed for surface mounting using conventional reflow soldering techniques. In accordance with normal recommendations for ceramic MLCC's, hand soldering should be avoided as soldering irons could cause thermal damage or disconnections within the device. If rework or manual placing is necessary, then the use of a hot air pencil is recommended. Preheating the board can assist with manual soldering. Pb free compatible.

Isopropanol and Methanol are both safe to use with soldered units.

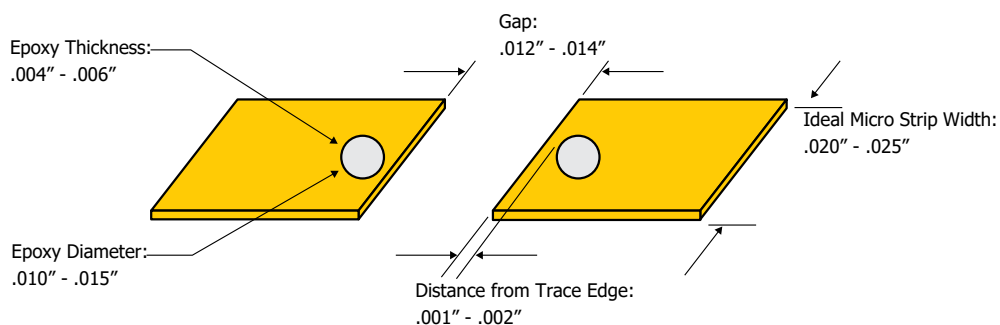

MLC - Broadband Blocks

Description

- Resonance free DC Blocking / Decoupling
- Less than 0.25 db loss @ 4 GHz (typical)
- Surface mountable

Functional Applications

- Fiber Optic Links • High Isolation Decoupling
- LAN's, VCO Frequency Stabilization • Diplexers
- RF/Microwave Modules • Instruments • Test Equipments

Mechanical Specification

Product Code	Body Dimensions			Band Dimensions (B)	
	Length (L)	Width (W)	Thickness (T)	Min	Max
C04BL	0.040" ± 0.008"	0.020" ± 0.006"	0.028" Max	0.003"	0.019"
C06 BL	0.060" ± 0.012"	0.031" ± 0.009"	0.036" Max	0.006"	0.03"
C08 BL	0.081" ± 0.020"	0.051" ± 0.013"	0.061" Max	0.012"	0.0468"
C18BL	0.1200" ± 0.925"	0.1100" ± 0.010"	0.100" Max	0.008"	0.045"

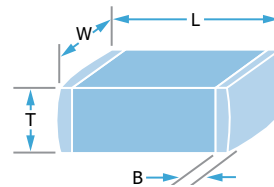

Part Characteristics

Part Number	Capacitance Guaranteed Minimum Value	Voltage Rating	Temperature Coefficient -55°C to 125°C	Maximum Dissipation Factor	Insulation Resistance (MΩ Minimum)	Aging Rate	Frequency Range	Termination
C04BL121X-5UN-X0T	120pF @ 1KHz, 2Vrms	50 Vdc	± 15%	3.0% @ 1KHz, 2Vrms	10 ⁴	<=1.5%/decade hours	10MHz – 40GHz	"U" & "S"
C06BL851X-1UN-X0T	850pF @ 1KHz, 2Vrms	100 Vdc 50 Vdc					2MHz – 30GHz	"U", "S" & "Z"
C08BL242X-5UN-X0T	2400pF @ 1KHz, 2Vrms	50 Vdc					1MHz – 20GHz	"U", "S" & "Z"
C08BL102X-1UN-X0T	1000pF @ 1KHz, 2Vrms	100 Vdc					1MHz – 20GHz	"U", "S" & "Z"
C18BL103X-4UN-X0T	10,000pF @ 1KHz, 2Vrms	500 Vdc					1MHz – 6GHz	"U", "S" & "Z"

Performance

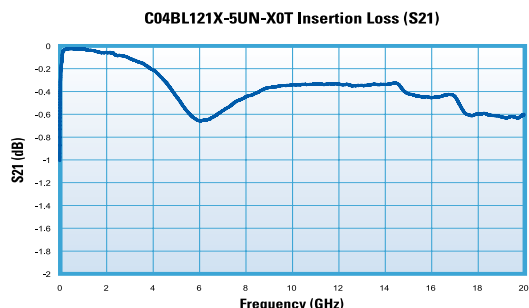
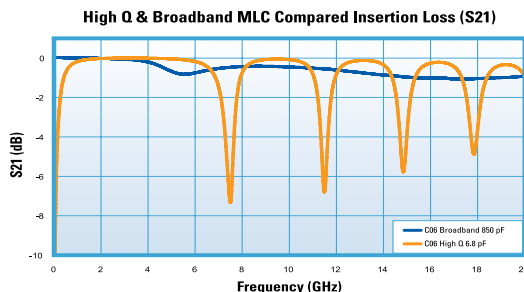
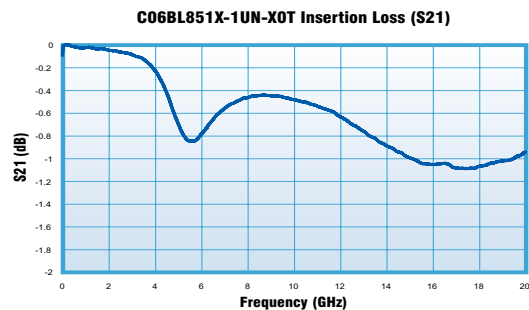
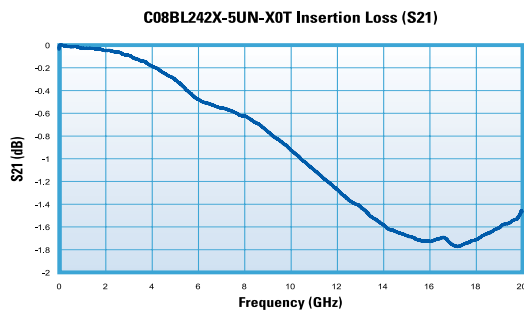

The information above represents typical device performance.

Series Description

DLI's Gain Equalizers are designed as a small, low cost solution to your gain slope challenges. These equalizer designs employ a monolithic construction with precision thin-film conductor and resistor films with proprietary high dielectric constant ceramics for superior RF performance and repeatability. Components are well suited for use with pick and place equipment.

Available in tape and reel packaging for high volume applications.

Applications

- Broadband Microwave Modules; EW, ECM, ECCM
- Equalizer is utilized as a compensation circuit to correct for a loss slope created by other elements within a circuit such as in amplifier stages

Benefits

- Low Excess Insertion Loss
- Footprint interchangeable part series, gain slopes from 1 to 3.5 dB
- Superior, repeatable microwave performance



- Ease of assembly; terminations are compatible with solder SMT and conductive epoxy assembly
- Package optimized for typical 50 Ω transmission line width
- No ground connection required

Part Number		L	W	T	Lp	Wp	G	Nominal Slope
Epoxy	Solderable							
AEQ2050	AEQ05510	30 \pm 2	18 \pm 2	5 \pm 1	9 \pm 1	14 \pm 1	8 \pm 1	2.25 dB
AEQ2199	AEQ05246	28 \pm 2	16 \pm 2	7 \pm 1	7 \pm 1	14 \pm 1	12 \pm 1	3.5 dB
AEQ2234	AEQ06042	32 \pm 2	16 \pm 2	5 \pm 1	8 \pm 1	12 \pm 1	12 \pm 1	3.25 dB
AEQ3042	AEQ3042	40 \pm 2	20 \pm 2	6 \pm 1	17.5 \pm 1	17.5 \pm 1	3 \pm 1	0.6 dB
AEQ3055	AEQ3055	40 \pm 2	20 \pm 2	6 \pm 1	15.4 \pm 1	18.4 \pm 1	7.2 \pm 1	1.5 dB
AEQ05467	AEQ05467	28 \pm 1	16 \pm 1	7 \pm 1	7 min.	14 \pm 1	10	1.0 dB
AEQ05468	AEQ05468	28 \pm 1	16 \pm 1	7 \pm 1	7 min.	14 \pm 1	10	1.5 dB
AEQ05469	AEQ05469	28 \pm 1	16 \pm 1	7 \pm 1	7 min.	14 \pm 1	10	2.0 dB
AEQ05470	AEQ05470	28 \pm 1	16 \pm 1	7 \pm 1	7 min.	14 \pm 1	10	2.5 dB
AEQ05471	AEQ05471	28 \pm 1	16 \pm 1	7 \pm 1	7 min.	14 \pm 1	10	3.0 dB
AEQ05472	AEQ05472	28 \pm 1	16 \pm 1	7 \pm 1	7 min.	14 \pm 1	10	3.5 dB

All dimensions in mils. Mechanical outline drawings for equalizers listed above are available. Please contact DLI Applications Engineering for details.

Physical Dimensions

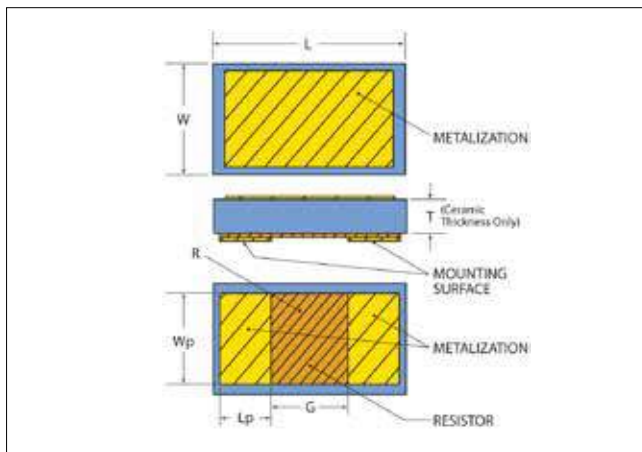

Equivalent Schematic Representation

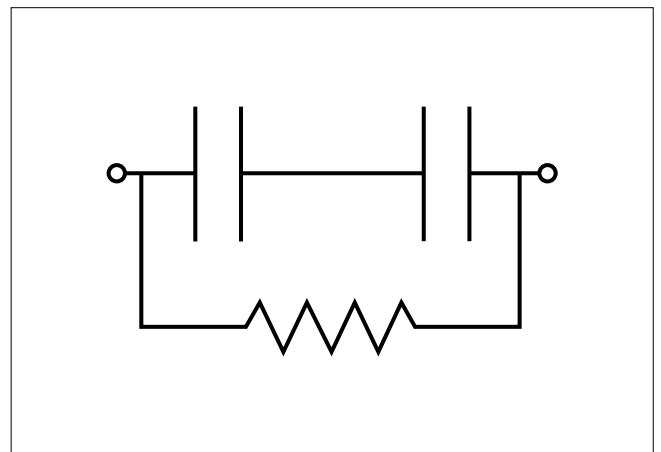

Typical Performance

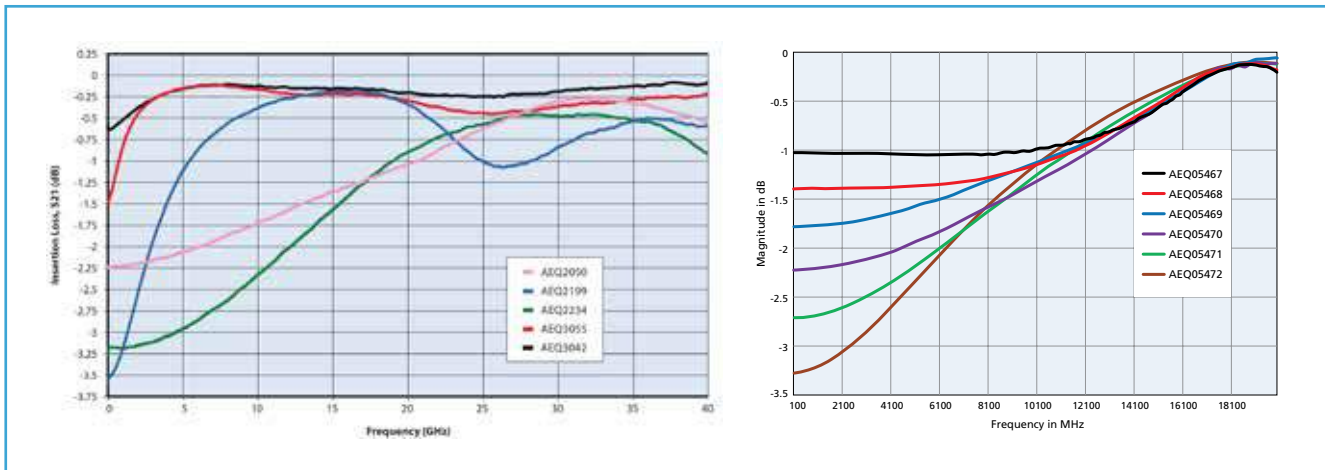

Die Attach Recommendations

- 1) Equalizer width should be approximately as wide as 50 Ω line trace on PCB.
- 2) The gap in the microstrip line should be nominally equal to dimension G.
- 3) Vacuum pick-up tool recommended for component handling. If pressure is to be applied during component placement, it should be done uniformly across the part.
- 4) Thin, unmounted circuit boards are prone to warpage during reflow. This can cause solder attach defects and cracking of components during handling or subsequent housing installation.

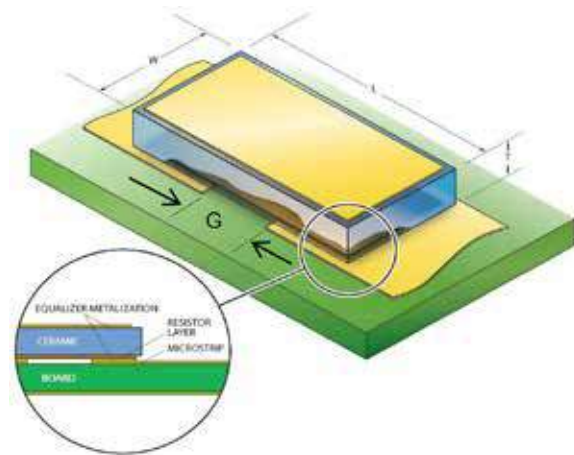

Custom Solutions

We realize that our standard offerings won't meet all customer requirements. DLI offers custom solutions with quick turn time.

Custom designs will be tailored to meet your system requirements by utilizing a design with one of our high K materials.

Temperature performance requirement? We can design on one of DLI's temperature stable materials.

Please contact Applications Engineering for more information.

Design Kits

Two design kits are available for quick fix or circuit tuning needs. Each kit has 5 pieces of the variant equalizer.

Standard Series includes: AEQ2050, AEQ2199, AEQ2234, AEQ3042 and AEQ3055.

EW Series includes: AEQ05467, AEQ05468, AEQ05469, AEQ05470, AEQ05471 and AEQ05472.

Qualifications



Miniature RF Blocking Network

Description

For RF Noise Suppression in high speed mixed signal semiconductor devices

- Eliminates Noise at I/O Pins
- Replaces Large Decoupling Capacitor
- with Superior Performance
- Clean DC Lines Beyond 18 GHz

Functional Applications

- High Speed Digital • Mixed Signal IC's
- Suppression of Noise on DC Supply Lines
- MCM and Hybrid Modules
- X7R Temperature and Voltage Stability

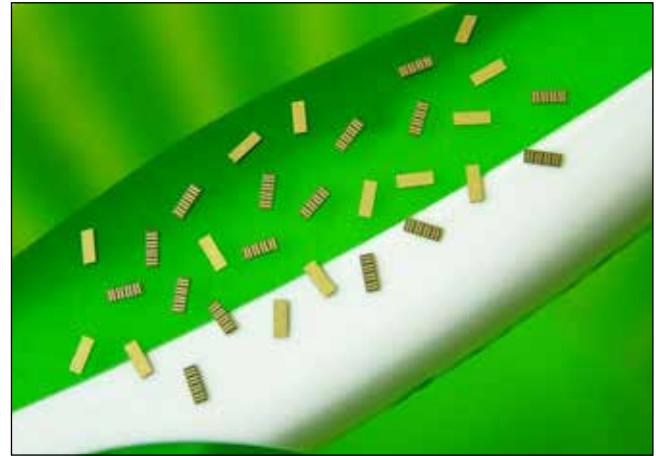

Layout and Dimensions

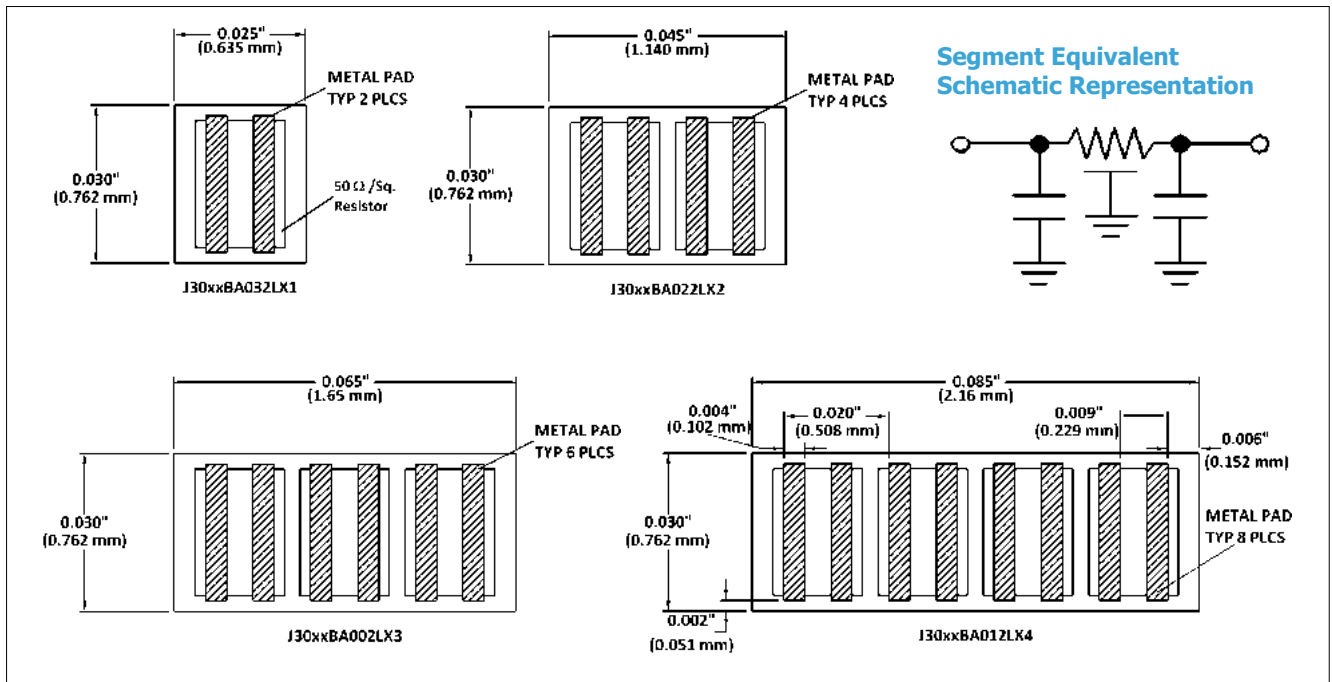

Material and Electrical Characteristics

Material Code	Capacitance (typical)	Resistance (pad to pad)	DF	TCC	Rated Voltage
BL	30 pF	10Ω Nom.	3.0% Max.	X7R	25 Vdc
BJ	45 pF	10Ω Nom.	3.0% Max.	X7R	25 Vdc

Ordering information - Miniature RF Blocking Network

J	30	BL	BA01	2	L	X	4
Product	Width (mils)	Material	Internal Drawing Reference	Voltage	Metallization	Test Level	Number of RC Segments
J = Blocking Network		BL BJ		2 = 25 Vdc	100μ" Gold Finish	Commercial	

Miniature RF Blocking Network

Metallization:

Top: 50Ω/Square TaN, 300Å TiW, 100μ Inch minimum Au.

Bottom: 300Å TiW, 100μ Inch minimum Au.

Screening Options

Test Code	Test/Inspection	Sample Size	Description
X	Bond Strength	2 Pcs/Plate	2 bonding pads on each sample
	IR	1% AQL	21/2 times rated voltage of 25 volts
	Visual Inspection	100%	4 Side visual screening
	Pad to pad resistance check	1% AQL	Ensure isolation between segments and boarder

Performance

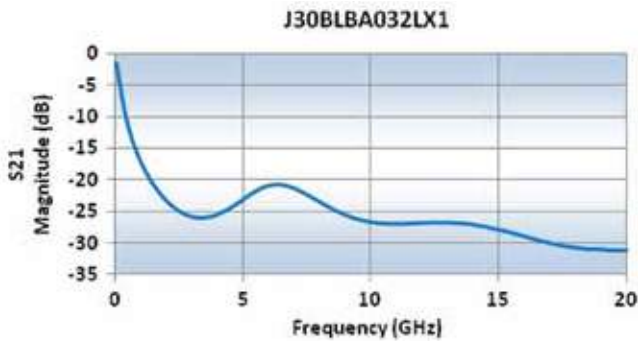

Segment Bonding for Measurement



Typical Application

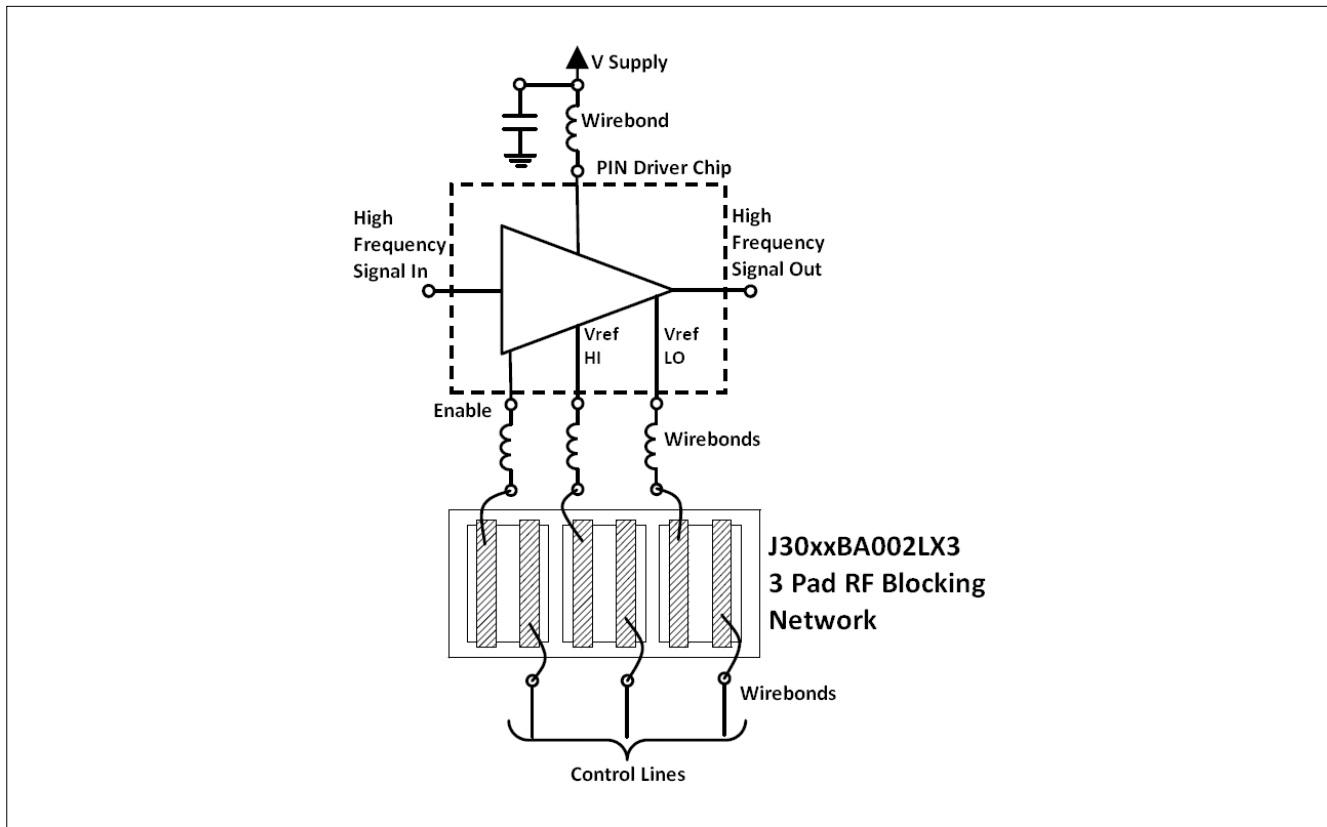

Note: For additional data of multi-segment devices please contact the Sales office.

Self Bias Network

Description

- Wireless communication modules
- MIC broadband high gain RF/Microwave module
- Bias line voltage divider and integrated decoupling capacitor
- Simplifies assembly with 1 component
- Improves gain flatness and stability in GaAs FET
- Miniature size: .020 x .034 (.5mm x .86mm)



Physical Characteristics

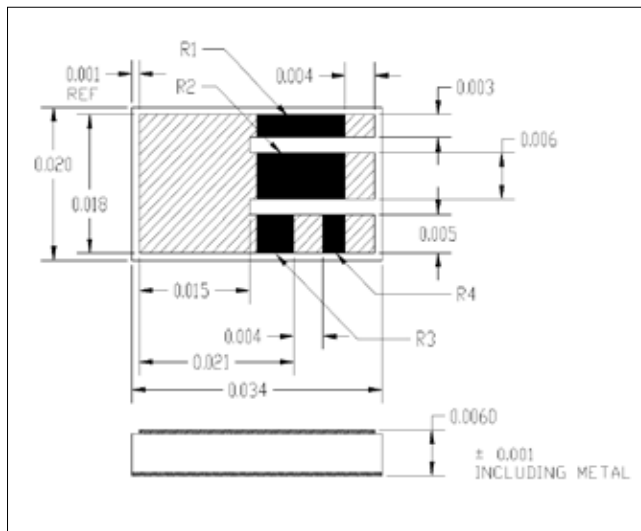

Equivalent Schematic Representation

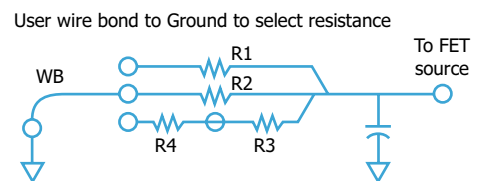

Resistor Values: Nominal Capacitance:

- R1 - 200Ω
 - R2 - 100Ω
 - R3 - 50Ω
 - R4 - 20Ω
- 50pF

Typical application requires 2 networks

Recommended Mounting: The Self Bias Network should be mounted with fully metalized side down directly on the RF ground plane for best performance.

Ordering information - Self Bias Network

B	28	BL	SBN01
Product	Width (mils)	Material	Network Type
B = Bias Network	28	BL ±25% TC	

Physical Characteristics

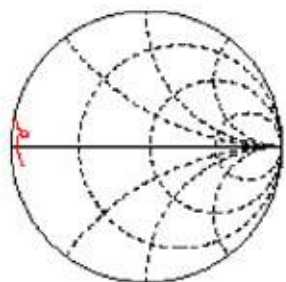

Typical S11
Frequency Range: 1.0 to 20 GHz
Reflection Coefficient: 50% Normalized

Typical Application

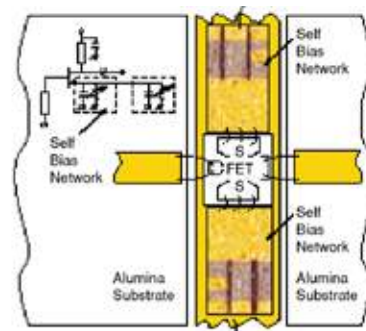

Note: Custom Networks can be designed per customer specification. Please consult factory for additional information or special requirements.

Bias Filter Network

Description

- Wireless communication modules
- Ideal varactor decoupling element
- High gain RF/Microwave modules
- Ideal GaAs FET gate biasing device
- MMIC multichip modules

Functional Applications

- Filters noise and RF from supplies
- Reduces RF feedback through bias supplies
- Simplifies assembly - one component replaces many
- Designed with large 4 mil wirebond pads for assembly ease

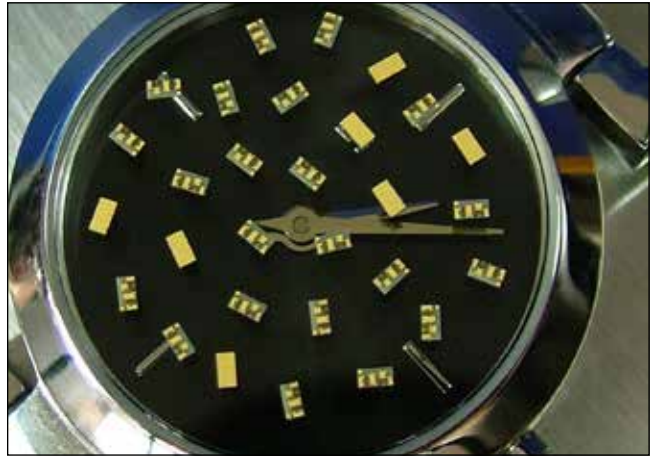

Equivalent Schematic Representation

Total Series Resistance: **Total Shunt Capacitance:**
DC Rating: Volts Max: 50V **I (ma) Max:** 10Ma

Recommended Mounting: The Bias Filter Network should be mounted with fully metallized side down directly on RF ground plane for maximum isolation performance.

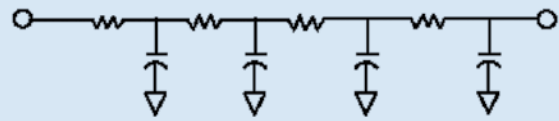

Physical Characteristics

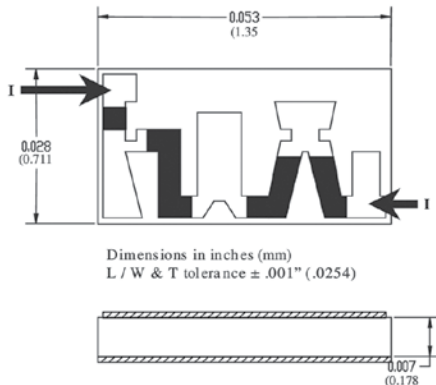

Typical Application

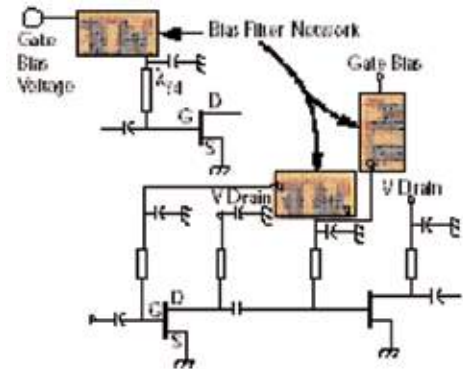

Ordering information - Bias Filter Network

B	28	BT	BFN01
Product	Width (mils)	Material	Network Type
B = Bias Network	28	BT +22, -56% BJ +/- 15% TC	

Isolation vs. Frequency

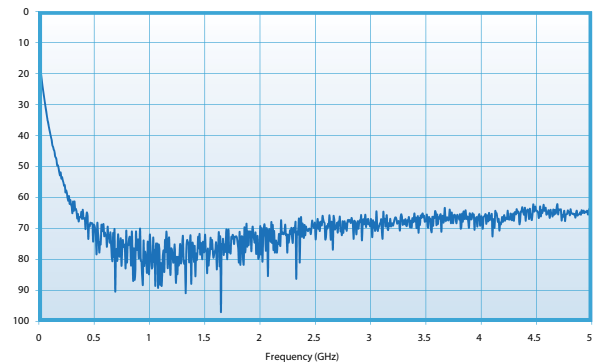
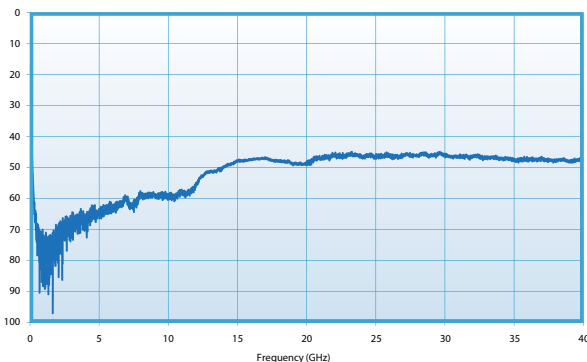

Note: Custom Networks can be designed per customer specification. Please consult factory for additional information or special requirements.



Trimmers



Pulse Capacitors



Special Discrete Filters



Half-turn Trimmers

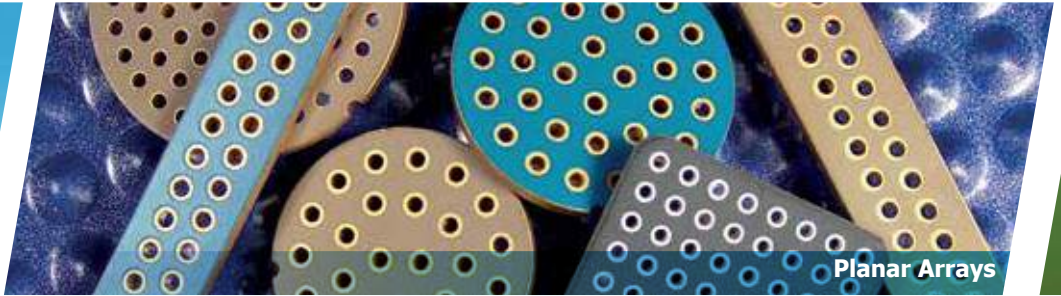

Planar Arrays



Air Capacitors



Feedthrough EMI Filters



Gain Equalizers



Specialty Products



Stacked Chips



Varistor Filters



Trimmer Ca

Other products available



Hi-Rel Products



Hi-Rel and Specialty Products

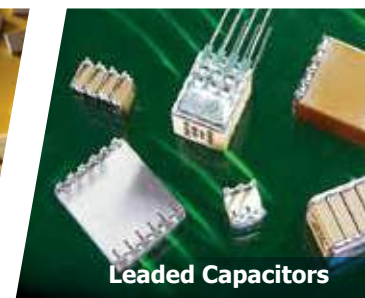

Leaded Capacitors



250Vac Chips



Special Filters

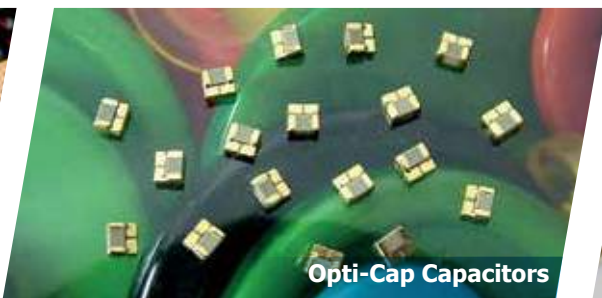

Opti-Cap Capacitors



Hi-Cap Capacitors

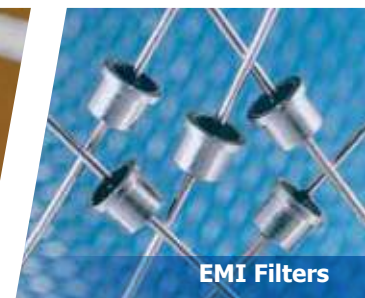

EMI Filters

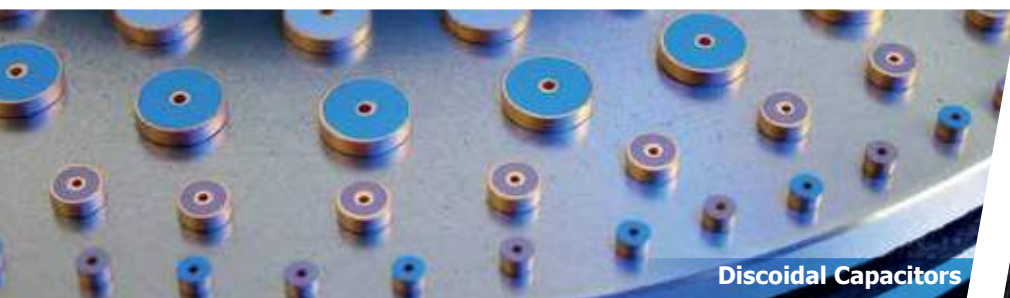

Discoidal Capacitors



capacitors



500Vac X7R Chips



X8R Capacitors

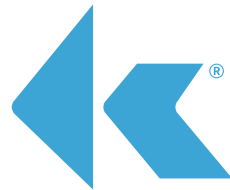

PRECISION DEVICES
knowles

**COMPEX • DLI • JOHANSON MFG
NOVACAP • SYFER • VOLTRONICS**

Asian Sales Office

O: +86 512 62588258

F: +86 512 62589258

KPD-Asia-sales@knowles.com

European Sales Office

O: +44 1603 723300

F: +44 1603 723301

KPD-Europe-sales@knowles.com

North American Sales Office

O: +1 661 295 5920

F: +1 661 295 5928

O: +1 315 655 8710

F: +1 315 655 0445

KPD-NA-sales@knowles.com