

SERIES

# 8069

シールドロック H=3.0mm

SHIELD LOCK

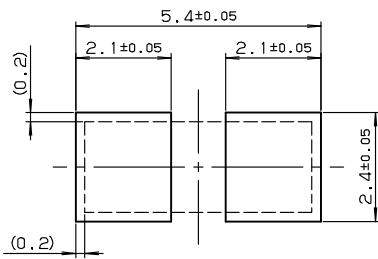

推奨パターンレイアウト  
RECOMMENDED PATTERN LAYOUT

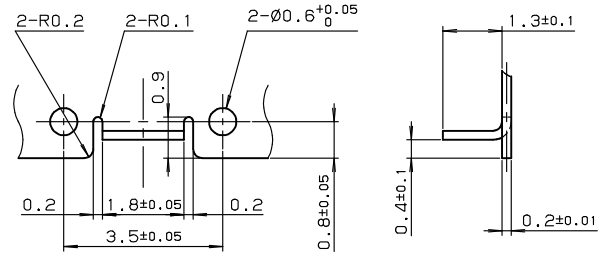

シールドケース形状  
SHIELDING CASE FORM

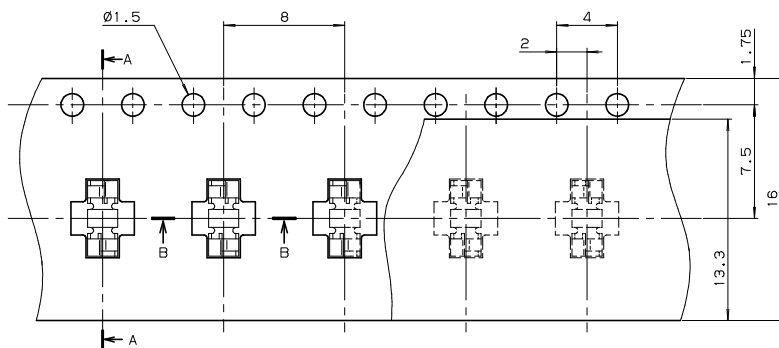
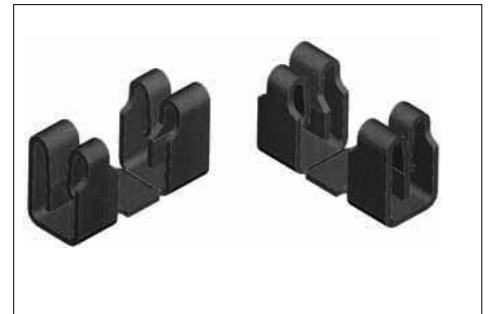
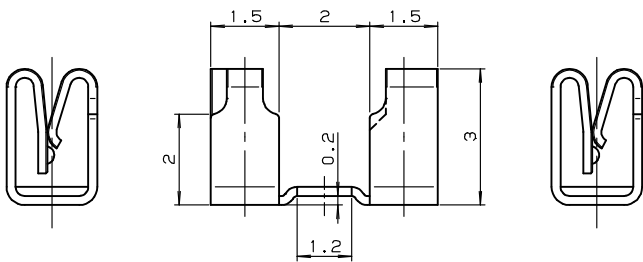
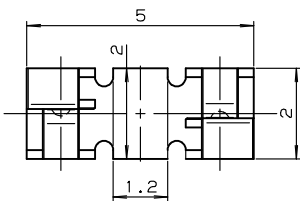

引出し方向  
USED DIRECTION OF FEED

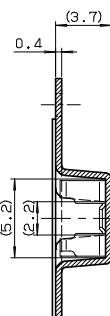

SECT. A-A

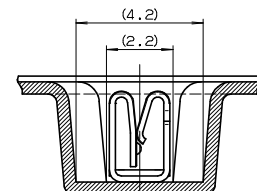

SECT. B-B

注文コード / Ordering Code

Part No. 04 8069 000 000 800 +



車載機器などの高い信頼性が求められる機器に本製品をご検討の場合は、弊社までお問い合わせください。  
If you use the product for equipment requiring high reliability such as automotive equipment, please contact us beforehand.

SERIES

# 8069

シールドロック H=1.8mm

SHIELD LOCK

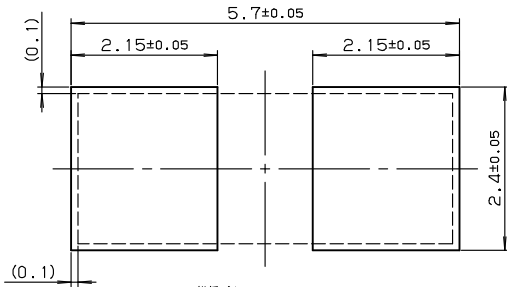

推奨パターンレイアウト  
RECOMMENDED PATTERN LAYOUT

シールドロック斜視図  
SHIELD LOCK

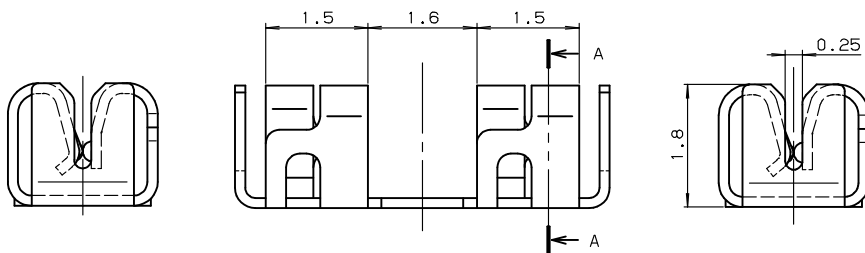
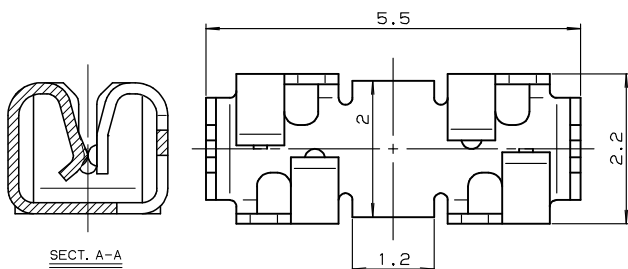
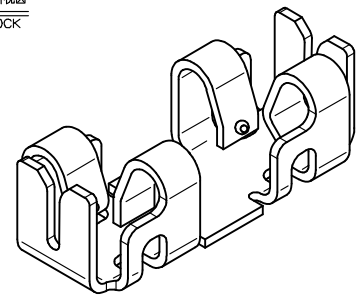

シールドロック嵌合状態斜視図  
SHIELD LOCK MATING

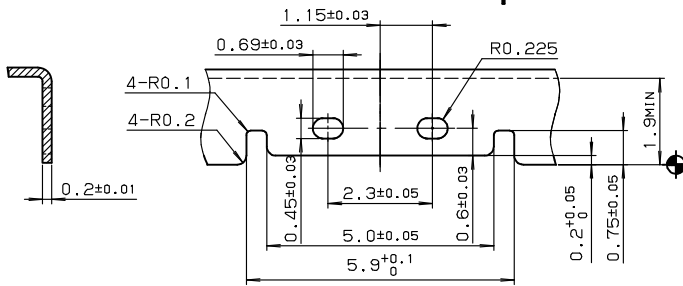
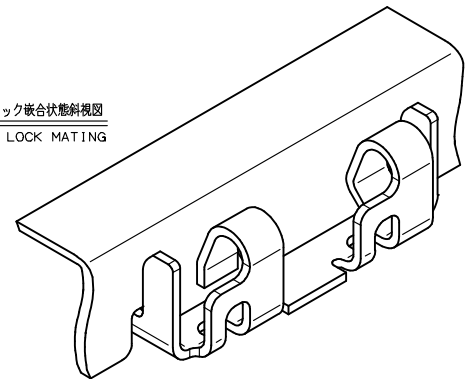

シールドケース形状  
SHIELDING CASE FORM

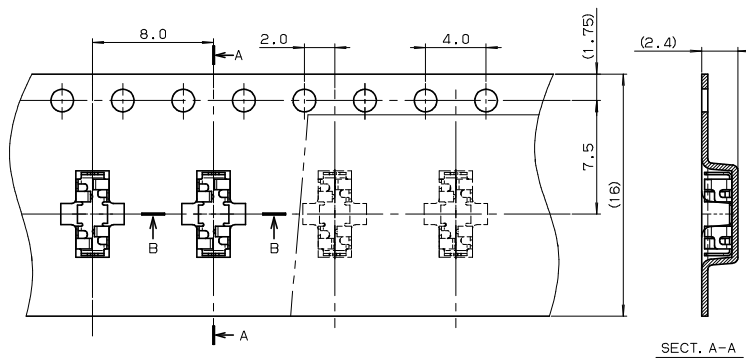

SECT. A-A

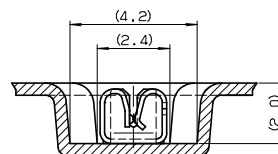

SECT. B-B

注文コード / Ordering Code

Part No. 04 8069 000 100 800 +



車載機器などの高い信頼性が求められる機器に本製品をご検討の場合は、弊社までお問い合わせください。  
If you use the product for equipment requiring high reliability such as automotive equipment, please contact us beforehand.