

ITV4030 12A Series



Agency Approvals

AGENCY	AGENCY FILE NUMBER	AMPERE RANGE
	TBD	TBD
	TBD	TBD

Thermal Derating Characteristics

	Ambient Operating Temperature		
	25°C	40°C	60°C
Recommend Rated Current (A)	13.5	12.0	10.0

Description

ITV4030 Series is a three terminals surface mountable battery protector which is designed to against both overcurrent and overvoltage (overcharging). A fuse element is embedded to cut off the circuit when overcurrent issue happens. A heater is also directly embedded under the fuse element, it will generate heat to blow the fuse once overvoltage detected by IC or FET.

Features

- Halogen Free
- Surface Mount
- Fast response
- Protection for both overcurrent and overcharging

Applications

- Notebook
- Cell phone
- Camera
- Ultrabook
- Tablet PC
- Automotive applications
- Printer
- Security systems
- Power tools
- Ecall

Electrical Characteristics

Part Number	Ordering Code	I _{rated} (A)	V _{max} (Vdc)	I _{break} (A)	V _{OP} (V)	Resistance		Agency Approvals	
						R _{heater} (Ω)	R _{fuse} (mΩ)		
ITV4030L0412	ITV4030L0412NR	12	36	50	3.0 ~ 4.5	0.6 ~ 1.5	0.018	X	X
ITV4030L0812	ITV4030L0812NR	12	36	50	4.0 ~ 9.0	2.0 ~ 3.2	0.010	X	X
ITV4030L1212	ITV4030L1212NR	12	36	50	7.4 ~ 13.8	2.0 ~ 3.2	0.0085	X	X
ITV4030L1412	ITV4030L1412NR	12	36	50	10.5 ~ 19.6	11.2 ~ 20.0	0.010	X	X
Current Capacity		100% x I _{rated} No Melting							
Cut Time		200% x I _{rated} < 1 min							
Interrupting Current		5 x I _{rated} , power on 5 ms, power off 995 ms, 10000 cycles No Melting							
Over Voltage Operation		In operation voltage range, the fusing time is <1min.							

Notes:

I_{rated} = Current carrying capacity that is measured at 40°C thermal equilibrium condition

I_{break} = The current that the fuse element is able to interrupt

V_{max} = The maximum voltage that can be cut off by fuse

R_{heater} = The resistance of the heating element

R_{fuse} = The resistance of the fuse element

Cells in series = Number of battery cells connected in series in the circuit for ITV device to protect.

• Value specified is determined by using the PWB with 2mm*2oz copper traces, AWG18 covered wire, and 0.6mm glass epoxy PCB.

• Specifications are subject to change without notice.

Cut Time by Heater Operation

Various heater wattage at 25°C ambient temperature

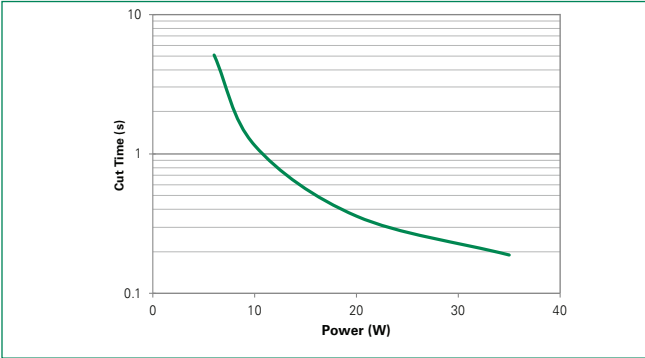

Constant heater wattage at various ambient temperature

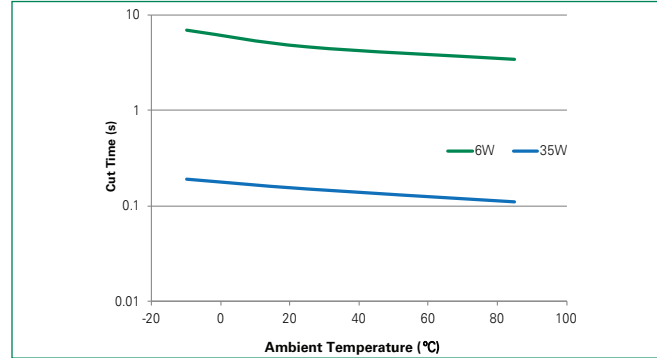

Cut Time by Current Operation

Various interrupting current at 25°C ambient temperature

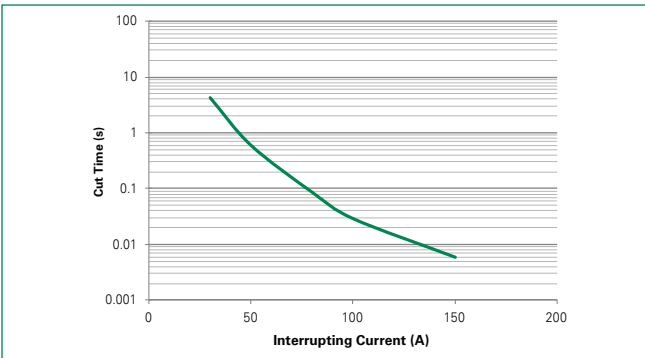

Constant 2x rated current at various ambient temperature

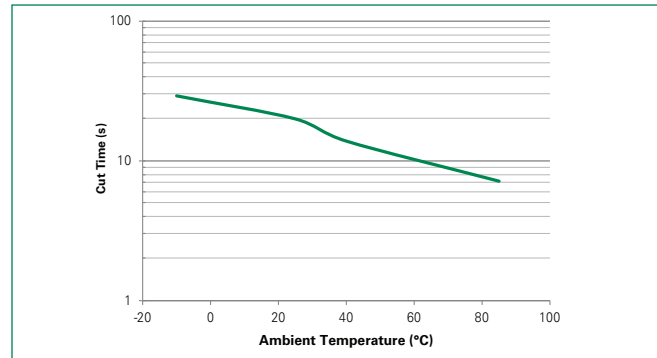

Environmental Specifications

Storage Temperature	0~35°C, ≤70%RH 3 months after shipment
Operating Temperature	-10°C to +65°C
Operating Electric Power	-25°C to +85°C/6~35W (applied to heater)
Hot Passive Aging	100±5°C, 250 hours No structural damage and functional failure
Humidity Aging	60°C±2°C, 90~95% R.H. 250 hours No structural damage and functional failure
Cold Passive Aging	-20±3°C, 500 hours No structural damage and functional failure
Thermal Shock	MIL-STD-202 Method 107G +125°C/-55°C, 100 times No structural damage and functional failure
Solvent Resistance	MIL-STD-202, Method 215
Vibration	MIL-STD-883C, Method 2007.1, Condition A No structural damage and functional failure

Physical Dimension (mm)

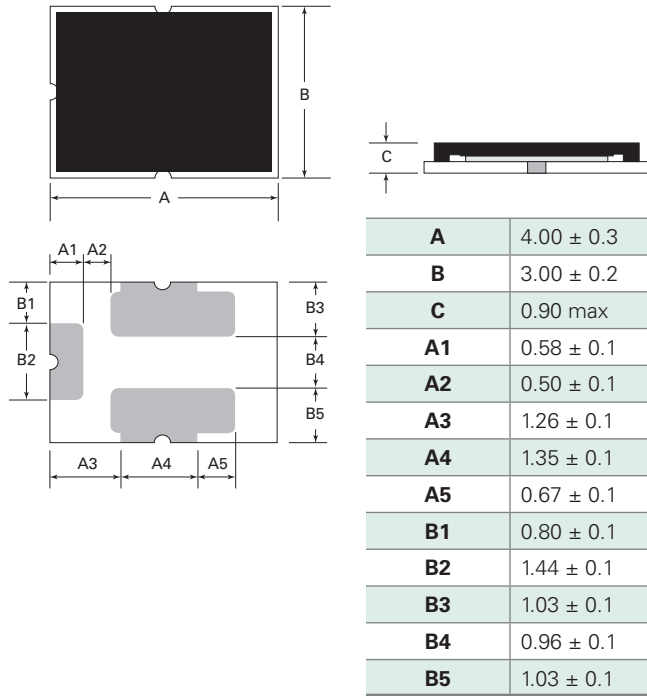

Device Circuit

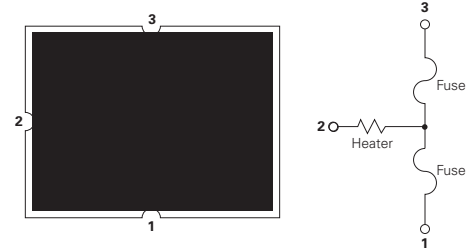

Board and Solder Layout Recommend (mm)

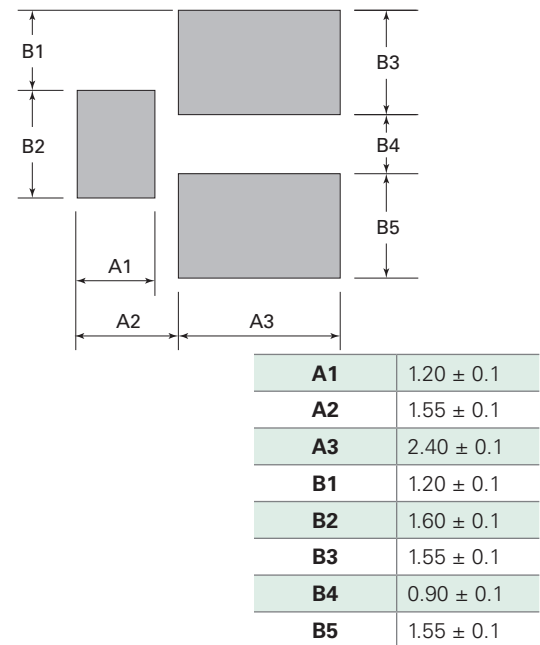

Physical Specifications

Material	Glass Epoxy PCB
Base Thickness	0.6mm
Copper Thickness	0.07mm
Covered Wire	AWG18

Soldering Parameters

Average Ramp-Up Rate ($T_{s_{max}}$ to T_P)		3°C/second max.
Preheat	Temperature Min ($T_{s_{min}}$)	150°C
	Temperature Max ($T_{s_{max}}$)	200°C
	Time ($T_{s_{min}}$ to $T_{s_{max}}$)	60-120 seconds
Time maintained above:	Temperature (T_L)	217°C
	Time (t_L)	60-105 seconds
Peak Temperature (T_P)		255°C
Time within 5°C of actual Peak Temperature (t_p)		5 seconds max.
Ramp-Down Rate		6°C/second max.
Time 25°C to Peak Temperature		8 minutes max.

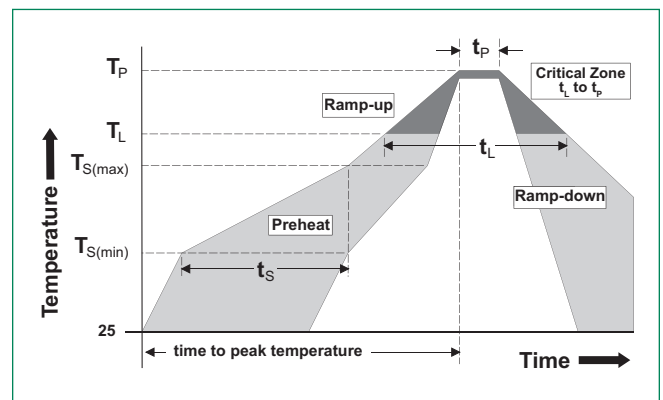

- All temperature refer to topside of the package, measured on the package body surface
- If reflow temperature exceeds the recommended profile, devices may not meet the performance requirements
- Recommended reflow methods: IR, vapor phase oven, hot air oven, N₂ environment for lead
- Recommended maximum paste thickness is 0.25mm (0.010inch)
- Devices can be cleaned using standard industry methods and solvents
- Devices can be reworked using the standard industry practices

Part Numbering System

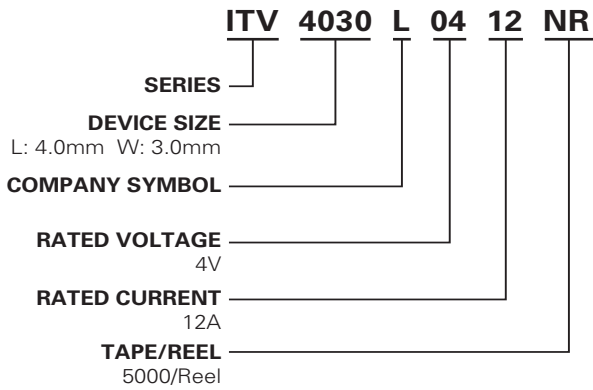

Part Marking System

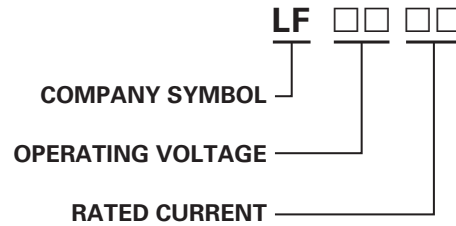

Packaging

Part Number	Tape and Reel Quantity
ITV4030LXX12	5,000

Installation and Handling Guidelines

- Before and after mounted, the ultrasonic-cleaning or immersion-cleaning must not be done to ITV device. The flux on element would flow, and it would not be satisfied its specification when cleaning is done. In addition, a similar influence happens when the product comes in contact with cleaning solution. These products after cleaning will not be guaranteed.
- Silicone-based oils, oils, solvents, gels, electrolytes, fuels, acids, and similar will adversely affect the properties of ITV devices, and shall not be used or applied.
- Please DO NOT reuse the ITV device removed by the soldering process.
- ITV devices are secondary protection devices and are used solely for sporadic, accidental overcurrent or overtemperature error condition, and shall NOT be used if or when constant or repeated fault conditions (such fault conditions may be caused by, among others, incorrect pin-connection of a connector) or over-extensive trip events may occur.
- Operation over the maximum rating or other forms of improper use may cause failure, arcing, flame and/or other damage to the ITV devices.
- The performance of ITV devices will be adversely affected if they are improperly used under electronic, thermal and/or mechanical procedures and/or conditions non-conformant to those recommended by manufacturer.
- Customers shall be responsible for determining whether it is necessary to have back-up, failsafe and/or fool-proof protection to avoid or minimize damage that may result from extra-ordinary, irregular function or failure of ITV devices.
- There should be minimum of 0.1mm spacing between ITV and surrounding compounds, to maintain the product characteristics and avoid damage other surrounding compounds.
- This product is designed and manufactured only for general-use of electronics devices. We do not recommend that it is used for the applications military, medical and so on which may cause direct damages on life, bodies or properties.

Tape and Reel Specifications (mm)

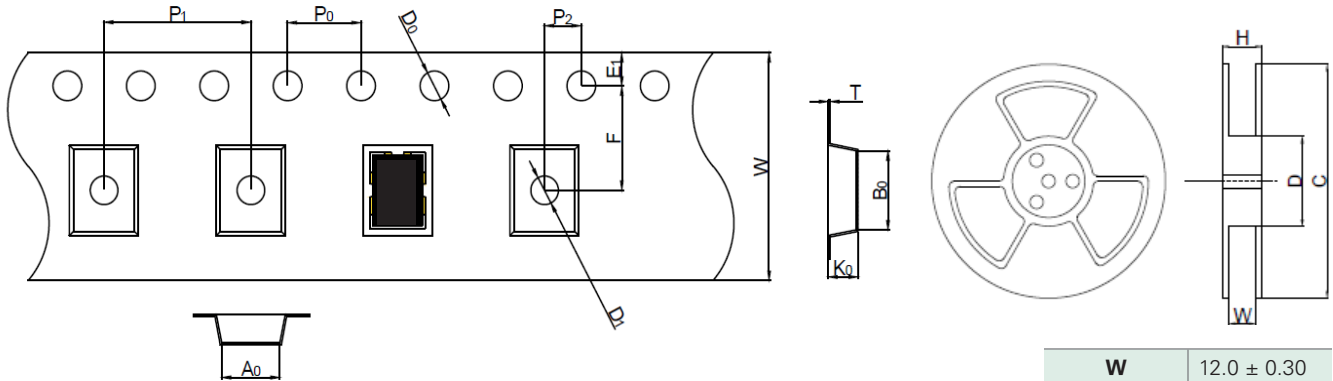

W	12.0 ± 0.30
F	5.50 ± 0.05
E1	1.75 ± 0.10
D0	1.55 ± 0.05
D1	1.50 ± 0.10
P0	4.00 ± 0.10
P1	8.00 ± 0.10
P2	2.00 ± 0.10
A0	3.32 ± 0.10
B0	4.32 ± 0.10
T	0.23 ± 0.05
K0	1.3 ± 0.10
H	16.5 ± 0.1
W	12.5 ± 1.5
D	Ø62.5 ± 0.5
C	Ø330 ± 1.0

Disclaimer Notice - Information furnished is believed to be accurate and reliable. However, users should independently evaluate the suitability of and test each product selected for their own applications. Littelfuse products are not designed for, and may not be used in, all applications. Read complete Disclaimer Notice at www.littelfuse.com/disclaimer-electronics.