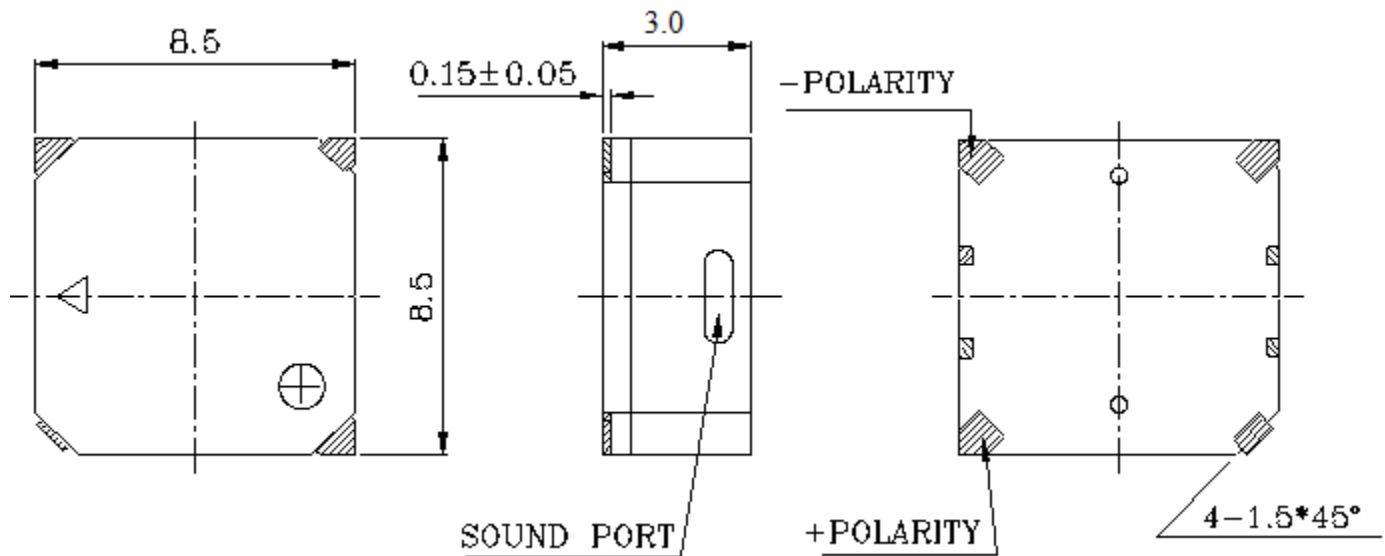

**Sales Outline Drawing**Revision **B****May not be suitable for all medical and aerospace applications.****Specifications: Contact Mallory Sonalert to discuss your application.**

Oscillation Frequency (Hz)	2731
Operating Voltage (Vp-p)	2 ~ 4
Rated Voltage (Vp-p)	3
Current Consumption Max. (mA)	80 at Rated Voltage
Sound Pressure Level (dB/min)	85 at 10cm at Rated Voltage
Coil Resistance ( $\Omega$ )	$16 \pm 3$
Operating Temperature ( $^{\circ}\text{C}$ )	$-20 \sim +70$
Storage Temperature ( $^{\circ}\text{C}$ )	$-30 \sim +80$
Type of Connection Terminal	SMD
Housing	LCP plastic resin (Color : Black)
Weight (Grams)	0.8
Condition by reflow soldering ( $^{\circ}\text{C}$ )	$250 \pm 5$ / within 10 sec
Condition by hand soldering ( $^{\circ}\text{C}$ )	$350 \pm 20$ / within 5 sec
Options	For other options contact factory

**Dimensions:** (units: mm)**RoHS Compliant****Packaging:**

Parts are supplied on cut tape.