

注記：
NOTES:

① 材質：TABLE 1参照
MATERIAL：SEE TABLE 1

② 梱包仕様書、製品仕様書、嵌合相手はSHEET 2をご参照ください。
PLEASE REFER TO SHEET 2 FOR PACKAGING SPECIFICATION, PRODUCT SPECIFICATION AND MATE WITH.

③ 本製品はコインなし品である。コインあり品は52670002-SD/PSD/000をご参照ください。
THIS PRODUCT IS WITHOUT COIN, PLEASE REFER TO 52670002-SD/PSD/000 FOR WITH COIN PRODUCT.

④ オーダー番号：ORDER NO.
22035**5

極数
CIRCUIT SIZE

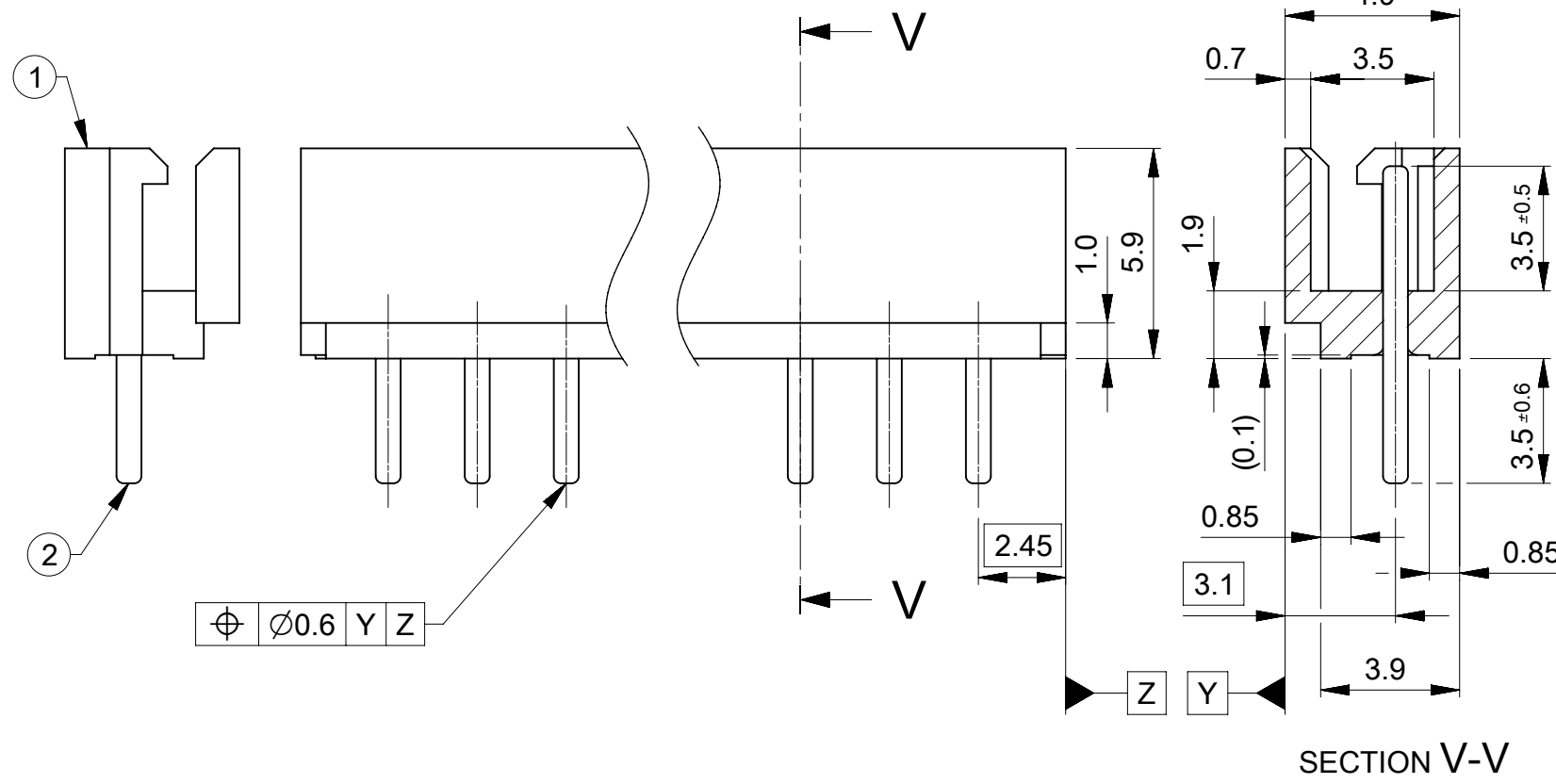

38.5±0.3	35	39.9±0.3	ポリ袋 POLY BAG	5267NA	526715A	22035155	15
36±0.3	32.5	37.4±0.3			526714A	22035145	14
33.5±0.3	30	34.9±0.3			526713A	22035135	13
31±0.3	27.5	32.4±0.3			526712A	22035125	12
28.5±0.25	25	29.9±0.25			526711A	22035115	11
26±0.25	22.5	27.4±0.25			526710A	22035105	10
23.5±0.25	20	24.9±0.25			526709A	22035095	9
21±0.25	17.5	22.4±0.25			526708A	22035085	8
18.5±0.25	15	19.9±0.25			526708A	22035075	7
16±0.25	12.5	17.4±0.25			526706A	22035065	6
13.5±0.25	10	14.9±0.25	526705A	22035055	5		
11±0.25	7.5	12.4±0.25	526704A	22035045	4		
8.5±0.2	5	9.9±0.2	526703A	22035035	3		
6±0.2	2.5	7.4±0.2	526702A	22035025	2		
C	B	A	梱包形態 PACKAGING	シリーズ番号 SERIES NO.	ENG. NO.	④ 発注番号 ORDER NO.	極数 CIRCUIT SIZE

① TABLE 1

番号 NO.	部品 PART	材質 MATERIAL	
①	ハウジング HOUSING	ポリアミド(PA), UL94V-0, 色: ナチュラル(アイボリー) POLYAMIDE(PA), UL94V-0, COLOR: NATURAL (IVORY)	
②	ピン PIN	母材 BASE METAL	黄銅(φ0.7) BRASS (φ0.7)
		めっき PLATING	錫めっき：3 micro-meter MIN. TIN
		下地めっき UNDERPLATING	銅めっき：1 micro-meter MIN. COPPER (UNDERPLATING)

DOCUMENT STATUS	P1	RELEASE DATE	2020/05/13	03:50:33
-----------------	----	--------------	------------	----------

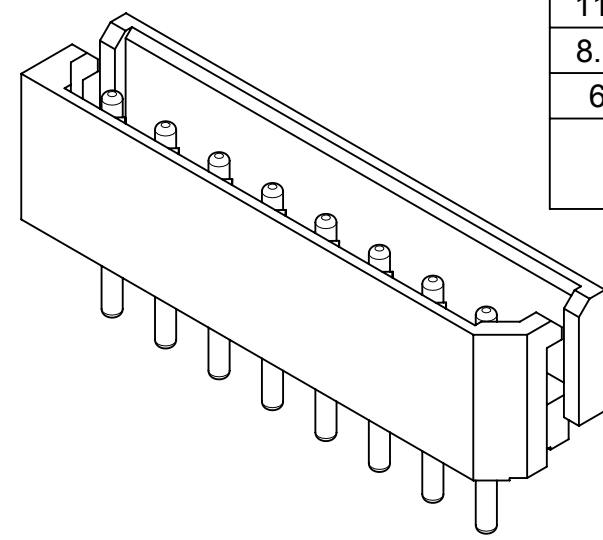

THIS DRAWING CONTAINS INFORMATION THAT IS PROPRIETARY TO MOLEX ELECTRONIC TECHNOLOGIES, LLC AND SHOULD NOT BE USED WITHOUT WRITTEN PERMISSION

CURRENT REV DESC: MIGRATED

DIMENSION UNITS	SCALE	<p>MINI-SPOX 2.5 W/B VERTICAL PLUG ASSEMBLY WITHOUT COIN COPPER UNDERPLATING</p> <p>PRODUCT CUSTOMER DRAWING</p>						
mm	NTS							
GENERAL TOLERANCES (UNLESS SPECIFIED)								
ANGULAR TOL ± 3.0°								
4 PLACES ±	EC NO: 636780							
3 PLACES ±	DRWN: SUDAYGUNAGI 2019/06/18							
2 PLACES ± 0.2	CHK'D: SAKIYAMA 2020/05/13							
1 PLACE ± 0.2	APPR: KOMURAKAMI 2020/05/13							
0 PLACES ±	INITIAL REVISION:							
DRAFT WHERE APPLICABLE MUST REMAIN WITHIN DIMENSIONS		DRWN: SUDAYGUNAGI 2019/06/18	2019/06/18	2020/05/13	DOCUMENT NUMBER	DOC TYPE	DOC PART	REVISION
THIRD ANGLE PROJECTION		DRAWING	SERIES	MATERIAL NUMBER	CUSTOMER	SHEET NUMBER		
		A3-SIZE	5267	SEE CHART	GENERAL	1 OF 2		

△ 適用製品及び各種仕様書
 APPLICABLE PRODUCTS AND VARIOUS SPECIFICATIONS

梱包仕様書 PACKAGING SPECIFICATION	ORDER NO. 22035**5	SPECIFICATION NO. SPK-5267-001 PS 001
嵌合相手 MATE WITH	RECEPTACLE HOUSING	
シリーズ番号 SERIES NO.	5264N	
製品仕様書 PRODUCT SPECIFICATION	PS-5264-001 PS 001	

2-8極
2-8 CIRCUIT

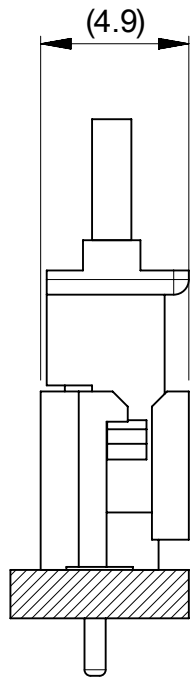

9-15極
9-15 CIRCUIT

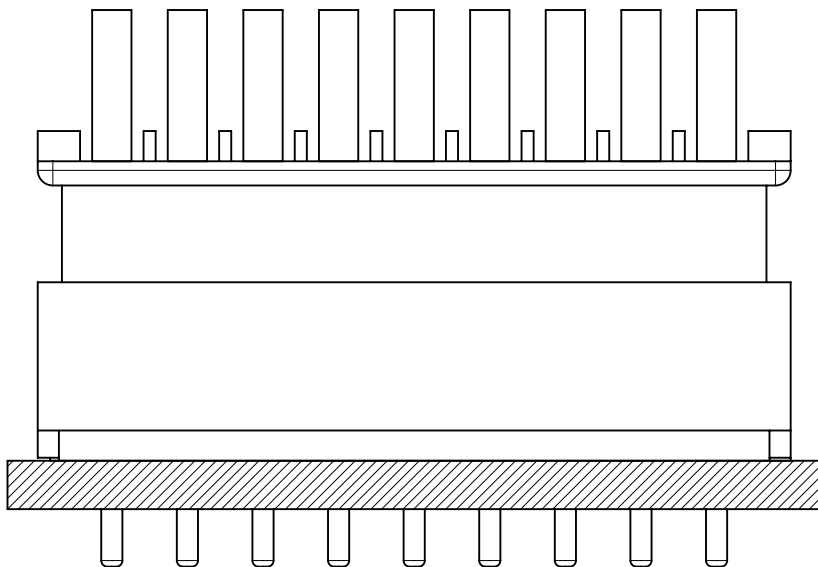
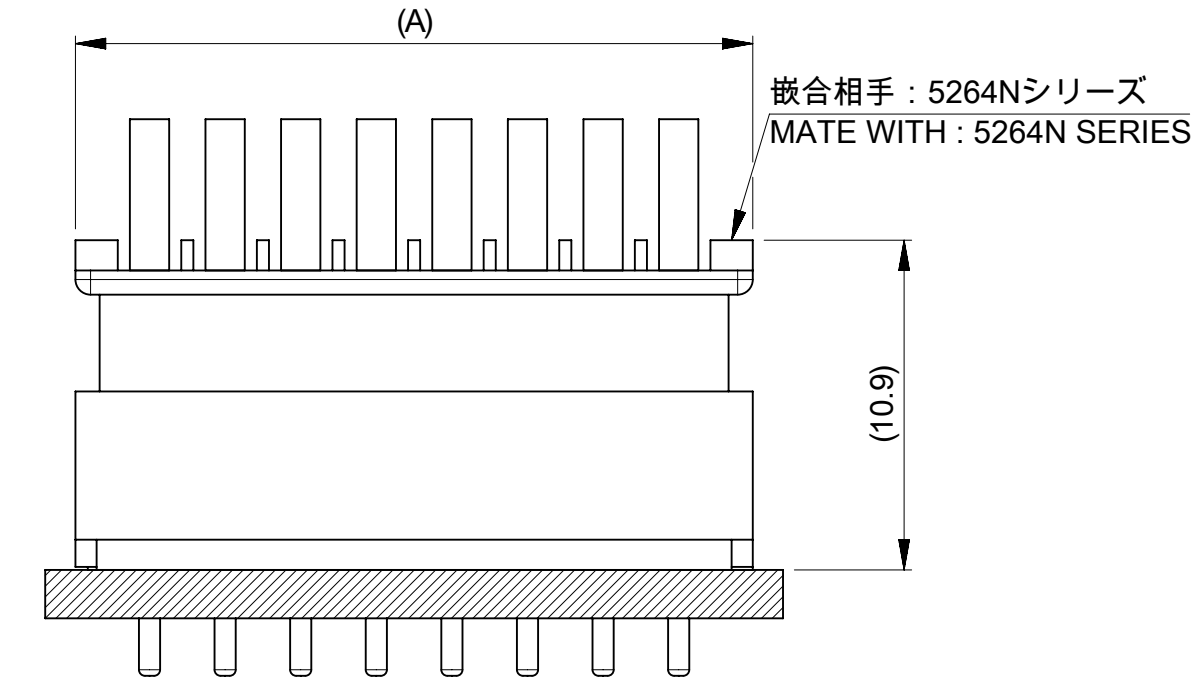
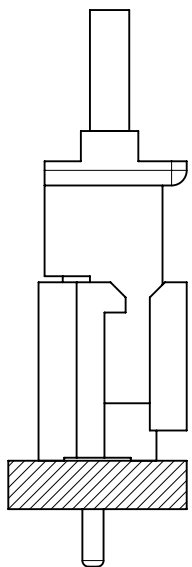

嵌合図
MATING CONNECTORS

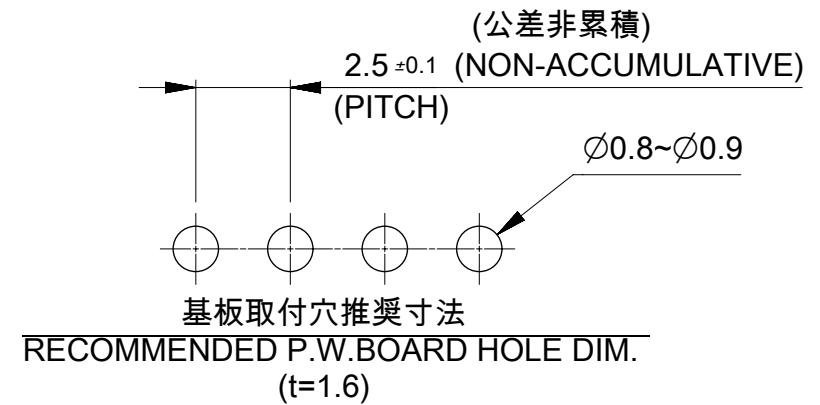

THIS DRAWING CONTAINS INFORMATION THAT IS PROPRIETARY TO MOLEX ELECTRONIC TECHNOLOGIES, LLC AND SHOULD NOT BE USED WITHOUT WRITTEN PERMISSION											
DIMENSION UNITS mm	SCALE NTS	CURRENT REV DESC: MIGRATED									
GENERAL TOLERANCES (UNLESS SPECIFIED)		EC NO: 636780								MINI-SPOX 2.5 W/B VERTICAL PLUG ASSEMBLY WITHOUT COIN COPPER UNDERPLATING	
ANGULAR TOL ± 3.0 °	4 PLACES ±	DRWN: SUDAYGUNAGI 2019/06/18			PRODUCT CUSTOMER DRAWING						
3 PLACES ±	3 PLACES ±	CHK'D: SAKIYAMA 2020/05/13			DOCUMENT NUMBER						
2 PLACES ± 0.2	2 PLACES ±	APPR: KOMURAKAMI 2020/05/13			52670001-SD						
1 PLACE ± 0.2	1 PLACE ±	INITIAL REVISION:			DOC TYPE						
0 PLACES ±	0 PLACES ±	DRWN: SUDAYGUNAGI 2019/06/18			PSD						
DRAFT WHERE APPLICABLE MUST REMAIN WITHIN DIMENSIONS		THIRD ANGLE PROJECTION		DRAWING		SERIES		MATERIAL NUMBER		CUSTOMER	
				A3-SIZE		5267		SEE SHEET 1		GENERAL	
								DOC PART		REVISION	
								000		A	
								SHEET NUMBER		2 OF 2	