

DETAIL "2"

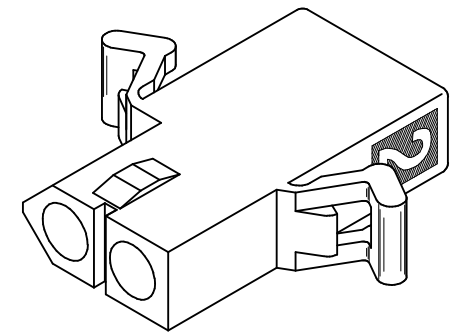
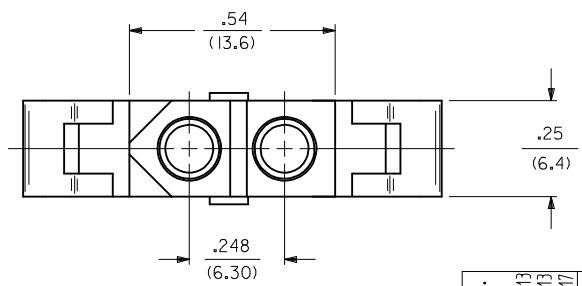
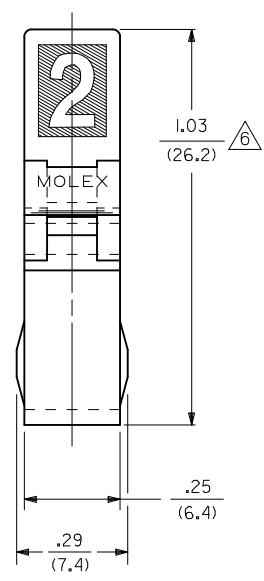
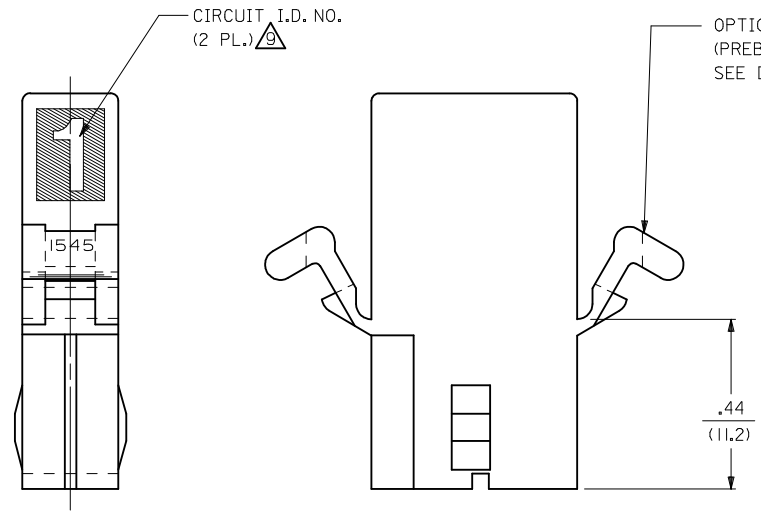

RECEPTACLE

<b>UPDATED NOTE REF.</b> EC NO: UCP2006-2303 DRW:PRIODER 2006/04/13 CHKD:AEHAG 2006/04/13 APPR:FSMITH 2006/04/17	<b>QUALITY SYMBOLS</b> ▽=0 ▽=0	<b>GENERAL TOLERANCES (UNLESS SPECIFIED)</b>		<b>DIMENSION STYLE</b> IN/MM	<b>SCALE</b> 4:1	<b>DESIGN UNITS</b> INCH	THIRD ANGLE PROJECTION
		4 PLACES ± --- ± --- 3 PLACES ± --- ± .010 2 PLACES ± 0.25 ± .014 1 PLACE ± 0.35 ± ---	mm INCH	DRAWN BY DATE GEP 8/9/88	TITLE .093 DIA. HOUSING PLUG & RECEPTACLE 2 CKT., .248/(6.30) CTR.		
		ANGULAR ± 1°	CHECKED BY DATE RW 8/9/88	APPROVED BY DATE RAS 8/9/88	MOLEX INCORPORATED		
		DRAFT WHERE APPLICABLE MUST REMAIN WITHIN DIMENSIONS	MATERIAL NO. SEE CHART	DOCUMENT NO. SD-1545-*	SHEET NO. 2 OF 3		

PLUG	
PART NO.	ENG. NO.
03-09-2021	I545-P
03-09-2022	I545-P1
03-09-7021	I545-PBK
03-09-7022	I545-PIBK
03-09-2023	I545-P2
03-09-7024	I545-PIRD
03-09-7023	I545-PIBU
50-36-1686	I545-P1-1

RECEPTACLE	
PART NO.	ENG. NO.
03-09-6021	I545-R3BK
03-09-6023	I545-R3RD
03-09-6024	I545-R3BU
03-09-1022	I545-R1
03-09-1023	I545-R2
03-09-6025	I545-RIBU
03-09-1027	I545-R3
50-36-1685	I545-R1-1

**LEGEND : PLUG**

1545-P\*\*\*\*\*

OPTIONS: \_\_\_\_\_

BLANK = WITH STD. EARS  
 1 = WITHOUT EARS  
 2 = WITH PREBENT EARS

COLOR: BLANK=NATURAL COLOR \_\_\_\_\_

AM=AMBER BK=BLACK BU=BLUE  
 BN=BROWN GY=GRAY GN=GREEN  
 OR=ORANGE RD=RED YW=YELLOW

BLANK = MATERIAL CODE A \_\_\_\_\_  
 1 = MATERIAL CODE B

**LEGEND : RECEPTACLE**

1545-R\*\*\*\*\*

BLANK = WITH STD. EARS & RAMPS \_\_\_\_\_  
 1 = WITHOUT EARS, WITH RAMPS  
 2 = WITHOUT EARS, WITHOUT RAMPS  
 3 = WITH PREBENT EARS & RAMPS

COLOR: BLANK=NATURAL COLOR \_\_\_\_\_

AM=AMBER BK=BLACK BU=BLUE  
 BN=BROWN GY=GRAY GN=GREEN  
 OR=ORANGE RD=RED YW=YELLOW

BLANK = MATERIAL CODE A \_\_\_\_\_  
 1 = MATERIAL CODE B

**NOTES:**

- MATERIAL: - A = NYLON, PA66, 94V-2. COLOR: SEE LEGEND.  
 B = UL94V-0, PA6 NYLON, IEC 60335-1, 4TH EDITION GLOW WIRE CAPABLE.
- FINISH: NONE.
- PRODUCT SPECIFICATION: PS-02-09.
- PACKAGING INFORMATION: PK-1545-001
- .97/(24.6) REF. FOR TOOLS BUILT PRIOR TO FEB. 1985.
- 1.00/(25.4) REF. FOR TOOLS BUILT PRIOR TO FEB. 1985.
- RIBS ARE PRESENT ONLY ON PARTS WITH MOUNTING EARS.
- EACH TERMINAL POCKET WILL ACCEPT UP TO:  
 (2) #18 AWG WIRES HAVING 1/32" THK. INSULATION OR  
 (1) #16 AWG WIRE HAVING 1/16" THK. INSULATION OR  
 (1) #16 AWG & (1) 18 AWG WIRE HAVING 1/32" THK. INSULATION .
- CIRCUIT I.D. NUMBERS ON SIDE OF HOUSING APPEAR ON PARTS FROM TOOLS BUILT AFTER 11/25/91.
- PARTS CONFORM TO CLASS 'B' REQUIREMENTS OF COSMETIC SPECIFICATION PS-45499-002 EXCEPT MATERIAL OPTION 'B' MEETS CLASS 'C' REQUIREMENTS FOR SINK AND DISCOLORATION.

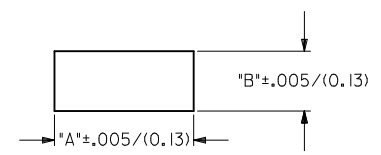
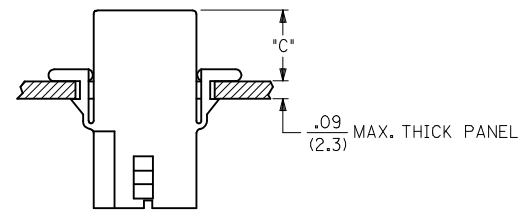

**RECOMMENDED PANEL OPENING**  
(SCALE 2:1)

HOUSING	DIM. "A"	DIM. "B"	DIM. "C" (PREBENT)	DIM. "C" (STD. EAR)
PLUG	.800/(20.32)	.375/(9.53)	.40/(10.2)	.39/(9.9)
RECEPTACLE	.725/(18.42)	.312/(7.92)	.41/(10.4)	.40/(10.2)

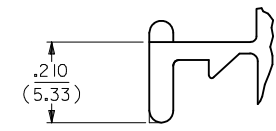

**DETAIL 3**

.093/(2.36) STANDARD MOUNTING EAR  
(SCALE 4:1)

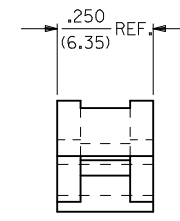

**DETAIL 4**

.093/(2.36) PREBENT MOUNTING EAR  
(SCALE 4:1)

<b>ADD MATL &amp; P/N'S</b> EC NO: UCP2007-2366 DR:WALHAG 2007/05/25 CHK:KLSCHMIDT 2007/06/01 APPR:FSMITH 2007/06/04 REV: V	<b>QUALITY SYMBOLS</b> ▽=0 ▽=0	<b>GENERAL TOLERANCES (UNLESS SPECIFIED)</b>		<b>DIMENSION STYLE</b> IN/MM	<b>SCALE</b> 2:1	<b>DESIGN UNITS</b> INCH	THIRD ANGLE PROJECTION	
		4 PLACES ± --- ± --- 3 PLACES ± --- ± .010 2 PLACES ± 0.25 ± .014 1 PLACE ± 0.35 ± ---	mm INCH DRAWN BY DATE GEP 8/9/88 CHECKED BY DATE RW 8/9/88 APPROVED BY DATE RAS 8/9/88	<b>TITLE</b> .093/(2.36) HOUSING, PLUG & RECEPTACLE, 2 CKT., .248/(6.30) CTR.		<b>MATERIAL NO.</b> SEE CHART	<b>DOCUMENT NO.</b> SD-1545-*	<b>SHEET NO.</b> 3 OF 3
		DRAFT WHERE APPLICABLE MUST REMAIN WITHIN DIMENSIONS		<b>MOLEX INCORPORATED</b>		THIS DRAWING CONTAINS INFORMATION THAT IS PROPRIETARY TO MOLEX INCORPORATED AND SHOULD NOT BE USED WITHOUT WRITTEN PERMISSION		