

**PLEASE CHECK WWW.MOLEX.COM FOR LATEST PART INFORMATION**

**Part Number:** **0190190026**  
**Status:** **Active**  
**Overview:** Standard Quick-Disconnect Terminals  
**Description:** Avikrimp Quick Disconnect, Female, for 14-16 (2.00-1.30mm<sup>2</sup>) Wire, Mylar Tape, Tab 2.79 x 0.81mm

**Documents:**

[Drawing \(PDF\)](#) [Product Specification PS-19902-015-001 \(PDF\)](#)  
[Product Specification PS-19902-011-001 \(PDF\)](#) [RoHS Certificate of Compliance \(PDF\)](#)  
[Product Specification PS-19902-014-001 \(PDF\)](#)

**Agency Certification**

CSA LR18689  
 UL E79133

**General**

Product Family Quick Disconnects  
 Series 19019  
 Crimp Quality Equipment Yes  
 Insulated Partial  
 Overview Standard Quick-Disconnect Terminals  
 Product Name Avikrimp  
 Type Quick Disconnect  
 UPC 800753038141

**Physical**

Barrel Type Closed  
 Color - Resin Blue  
 Flammability 94V-2  
 Gender Female  
 Glow-Wire Capable No  
 Insulation Nylon (PA)  
 Lock to Mating Part None  
 Material - Metal Brass  
 Material - Plating Mating Tin  
 Material - Plating Termination Tin  
 Net Weight 0.623/g  
 Orientation Straight  
 Packaging Type Adhesive Tape on Reel  
 Polarized to Mating Part No  
 Tab Thickness 0.81mm  
 Tab Width 2.79mm  
 Temperature Range - Operating -65° to +105°C  
 Wire Insulation Diameter 3.50mm max.  
 Wire Size AWG 14, 16  
 Wire Size mm<sup>2</sup> 1.30-2.00

**Electrical**

Voltage - Maximum 300V

**Solder Process Data**

Lead-free Process Capability N/A

**Material Info**

Engineering Number BB-8135T

**Reference - Drawing Numbers**

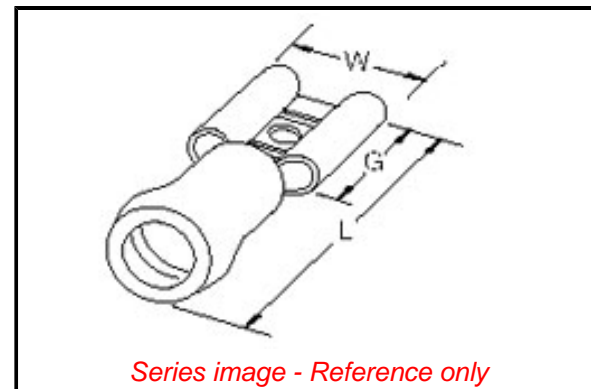

**EU ELV**

**Not Relevant**

**EU RoHS**

**Compliant**

**REACH SVHC**

Not Contained Per  
 -ED/88/2018 (15  
 January 2019)

**Halogen-Free**

**Status**

**Low-Halogen**

For more information, please visit [Contact US](#)

China ROHS

ELV

RoHS Phthalates

**China RoHS**

Green Image

Not Relevant

Not Contained

**Search Parts in this Series**

19019 Series

**Application Tooling | FAQ**

*Tooling specifications and manuals are found by selecting the products below. Crimp Height Specifications are then contained in the Application Tooling Specification document.*

**Global**

Description	Product #
ATP Crimp Dies for the Tape Crimp Module and ATP-101 & 301 Press	<u>192880145</u>
Mini-Mac Applicator	<u>638850900</u>

Product Specification

Sales Drawing

PS-19902-011-001, PS-19902-014-001,  
PS-19902-015-001  
SD-19019-001

This document was generated on 04/14/2020

**PLEASE CHECK [WWW.MOLEX.COM](http://WWW.MOLEX.COM) FOR LATEST PART INFORMATION**