

PLEASE CHECK WWW.MOLEX.COM FOR LATEST PART INFORMATION

Part Number: **0190190028**
Status: **Active**
Overview: Standard Quick-Disconnect Terminals
Description: Avikrimp Quick Disconnect, Female, for 14-16 (2.00-1.30mm²) Wire, Box, Tab 4.75 x 0.81mm

Documents:

[Drawing \(PDF\)](#) [Product Specification PS-19902-014-001 \(PDF\)](#)
[Product Specification PS-19902-011-001 \(PDF\)](#) [RoHS Certificate of Compliance \(PDF\)](#)

Agency Certification

CSA LR18689
 UL E79133

General

Product Family Quick Disconnects
 Series 19019
 Crimp Quality Equipment Yes
 Insulated Partial
 Overview Standard Quick-Disconnect Terminals
 Product Name Avikrimp
 Type Quick Disconnect
 UPC 800753038165

Physical

Barrel Type Closed
 Color - Resin Blue
 Flammability 94V-2
 Gender Female
 Glow-Wire Capable No
 Insulation Nylon (PA)
 Lock to Mating Part None
 Material - Metal Brass
 Material - Plating Mating Tin
 Material - Plating Termination Tin
 Net Weight 0.815/g
 Orientation Straight
 Packaging Type Bag
 Polarized to Mating Part No
 Tab Thickness 0.81mm
 Tab Width 4.75mm
 Temperature Range - Operating -65° to +105°C
 Wire Insulation Diameter 3.50mm max.
 Wire Size AWG 14, 16
 Wire Size mm² 1.30-2.00

Electrical

Voltage - Maximum 300V

Solder Process Data

Lead-free Process Capability N/A

Material Info

Engineering Number BB-8138-032

Reference - Drawing Numbers

Product Specification PS-19902-011-001, PS-19902-014-001
 Sales Drawing SD-19019-001

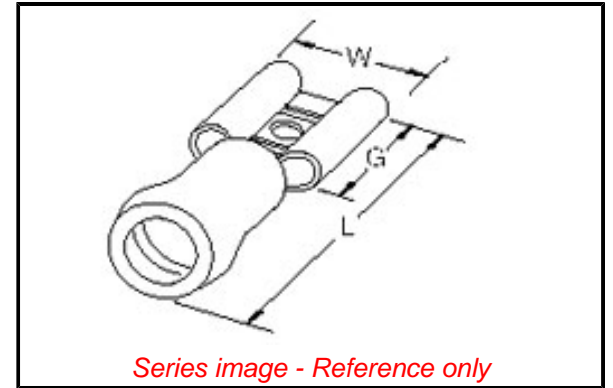

EU ELV

Not Relevant

EU RoHS

Compliant

REACH SVHC

Not Contained Per
 -ED/88/2018 (15
 January 2019)

Halogen-Free

Status

Low-Halogen

For more information, please visit [Contact US](#)

China ROHS

ELV

RoHS Phthalates

China RoHS

Green Image

Not Relevant

Not Contained

Search Parts in this Series

19019 Series

Application Tooling | FAQ

Tooling specifications and manuals are found by selecting the products below. Crimp Height Specifications are then contained in the Application Tooling Specification document.

Global

Description

Product #

PremiumGrade HandCrimp Tool 640010200
 Crimp Head for the AT-200 Pneumatic Hand Tool 640050200

This document was generated on 04/14/2020

PLEASE CHECK WWW.MOLEX.COM FOR LATEST PART INFORMATION