

**PLUG**

**RECEPTACLE**

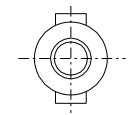
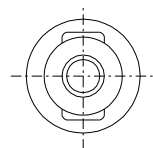
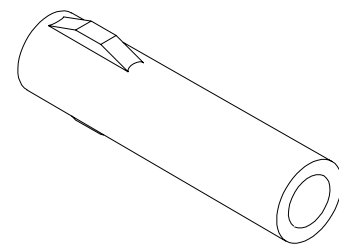
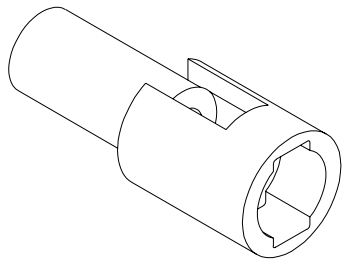
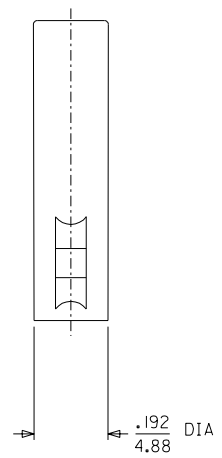
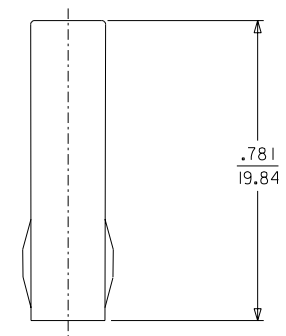
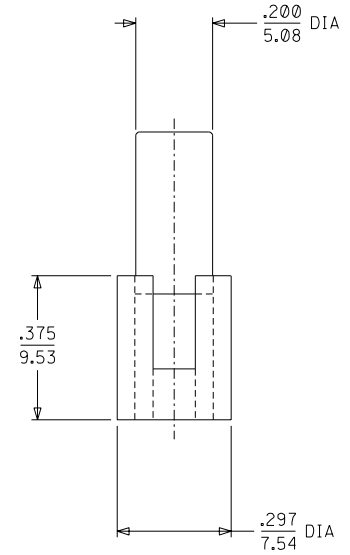
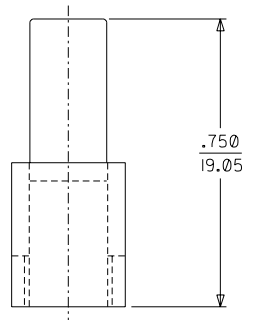
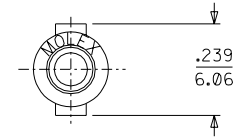
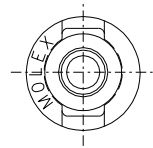

**PLUG HOUSING**

**RECEPTACLE HOUSING**

REDRAWN ON CAD  
 EC NO. LUCP2003-2578  
 DRWN: BSYNNOTT 6/10/03  
 CHK: BWIRKLUS 6/13/03  
 APPR: BWIRKLUS 6/16/03

QUALITY SYMBOLS  
 MAJOR =   
 CRITICAL =   
 DESCRIPTION  
 REV

GENERAL TOLERANCES: (UNLESS SPECIFIED)  

	mm	INCH
4 PLACES	±0.---	±.
3 PLACES	±0.	±.010
2 PLACES	±0.25	±.014
1 PLACE	±0.35	±.

 ANGULAR: ± 1°  
 DRAFT WHERE APPLICABLE MUST REMAIN WITHIN DIMENSIONS

SCALE 4 : 1  
 DESIGN UNITS  mm  INCH  
 DRAWN BY & DATE  
 JBS 6/10/03  
 CHECKED BY & DATE  
 BW 6/13/03  
 APPROVED BY & DATE  
 BW 6/16/03  
 CAD FILENAME  
 SD1625IX1.DGN

DIMENSIONS:  mm  INCH  mm ONLY  
 THIRD ANGLE PROJECTION  
 TITLE: PLUG & RECEPTACLE HOUSINGS I CIRCUIT, .062/(1.57) DIA. SERIES  
 Molex MOLEX INCORPORATED  
 MATERIAL NO. SEE CHART  
 DRAWING NO. SD-1625-1\*-\*  
 SHEET NO. 1 OF 2  
 THIS DRAWING CONTAINS INFORMATION THAT IS PROPRIETARY TO MOLEX INCORPORATED AND SHOULD NOT BE USED WITHOUT WRITTEN PERMISSION.  
 SIZE C

2	H
1	H
	REV
	REVISE ON CAD ONLY



DWG. NO. SD-1625-IR

ALL DIMENSIONS IN METRIC DO NOT SCALE DRAWING

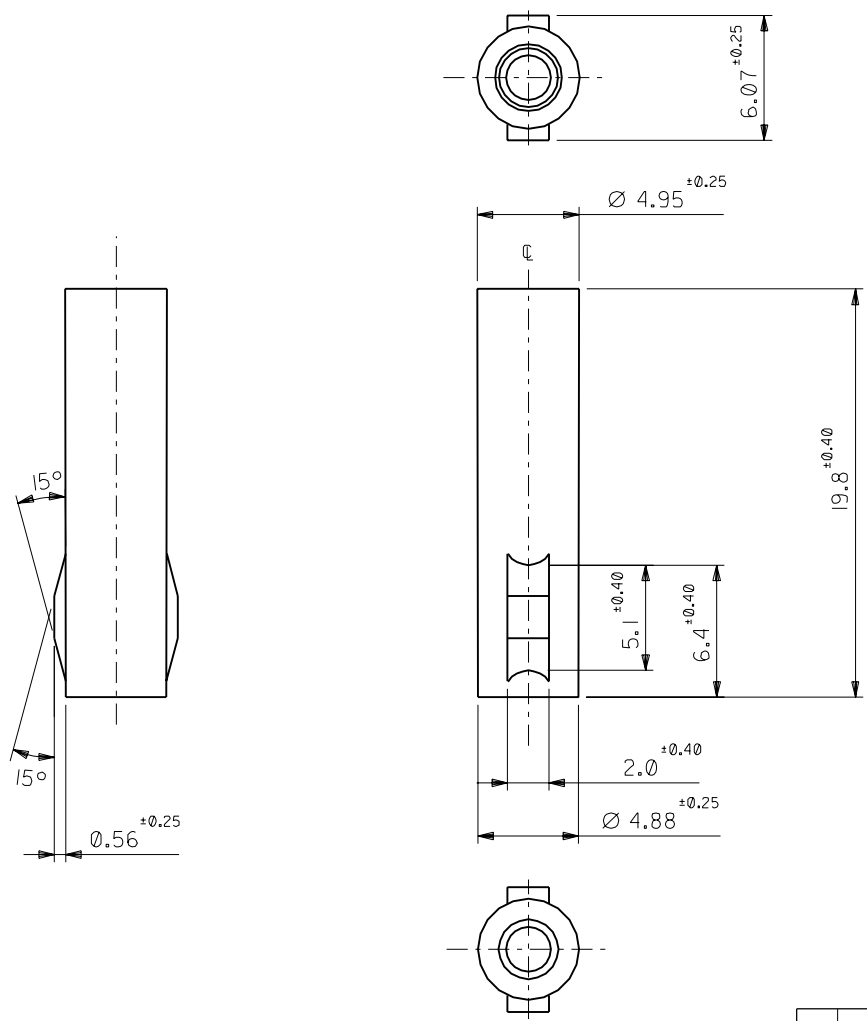

注記  
NOTE

材質: ナイロン66, 94V-2  
MATERIAL: NYLON66, 94V-2

03-06-1011	1625-IR
PART NO.	ENG. NO.

材料 MATERIAL		☑中参照 REFER TO DRAWING	
仕上げ FINISH		—	
適用電線範囲 WIRE RANGE		—	
被覆外径 INS. RANGE		—	
DRAWN BY '96/07/01 H.IIJIMA	CHK'D BY '96/07/01 M.FUKUSHIMA	DWG. NO. SD-1625-IR	
APP'D BY '96/07/01 M.ENOMOTO	尺度 SCALE 1:1	REV B	
記号 LTR	変更内容 REVISION RECORD	DR. CHK.	日付 DATE
B	再作図 REDRAWN (JC70305)	H.I	'96/07/01
一般公差 GENERAL TOLERANCES		M.F	
角度 ANGLE	±30°		
30以上 OVER	±0.3		
10以上 30未満 OVER UNDER	±0.25		
10未満 UNDER	±0.2		

MOLEX-JAPAN CO.,LTD.  
日本モレックス株式会社

REVISE ONLY ON CAD SYSTEM

TITLE 名称  
.062 DIA. 1 CIRCUIT  
RECEPT. HOUSING