

Distributed by:

JAMECO[®]
ELECTRONICS

www.Jameco.com ♦ 1-800-831-4242

The content and copyrights of the attached
material are the property of its owner.

Jameco Part Number 224400

1.57mm (.062") Pin Diameter .062" Pin and Socket Male Terminals Standard .062"

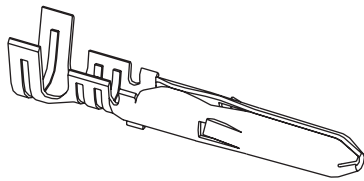

Features and Benefits

- Available in Tin or Gold platings
- Available in Brass or Phosphor Bronze base materials
- Accommodates 18 to 30 gauge wire

Reference Information

Packaging: Bag or reel
UL File No.: E29179
CSA File No.: LR19980
Designed In: Inches

Electrical

Contact Resistance: 3.2 milliohms max.
Current: 5.0 A

Mechanical

Contact Insertion Force: 15.57N max.
Durability: Tin—25 cycles max.
Gold—50 cycles max.

Physical

Contact: Brass or Phosphor Bronze
Plating: Tin or Gold
Operating Temperature: -40 to +105°C

Type	Plating	Crimp Wire Size	Insulation Diameter	Series	Order No.		Lead-free
					Chain	Loose	
Standard Brass .008"	Tin	18-24	1.52/3.05 (.060/.120)	1560	02-06-2101	02-06-2103	Yes
		24-30	1.02/2.29 (.040/.090)	1854	02-06-2131	02-06-2132	
	15µl" Gold	18-24	1.52/3.05 (.060/.120)	1560	02-06-6100	02-06-6103	
		24-30	1.02/2.29 (.040/.090)	1854	02-06-6130	02-06-6135	
	30µl" Gold	18-24	1.52/3.05 (.060/.120)	1560	02-06-6101	02-06-6102	
		24-30	1.02/2.29 (.040/.090)	1854	02-06-6138	02-06-6139	
	30µl" Gold Contact Tin Crimp	18-24	1.52/3.05 (.060/.120)	1560	02-06-6118	02-06-6119	
		24-30	1.02/2.29 (.040/.090)	1854	02-06-6143	02-06-6144	
.008" Phosphor Bronze	Tin	18-24	1.52/3.05 (.060/.120)	1786	02-06-2201	02-06-2202	
	Gold (15µl")	18-24	1.52/3.05 (.060/.120)	1786	02-06-6201	02-06-6202	
.008" PC Tail Brass for Standard .062" Housings Only	Tin			1778	02-06-8103		
	30µl" Gold Tin Tail Area					02-06-6122	

Note: .006 Phosphor Bronze stock recommended for versions 15 circuits and larger

3.68mm (.145") Pitch .062" Pin and Socket Receptacle Standard .062"

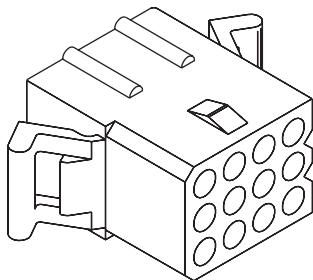

Features and Benefits

- Friction lock
- Panel and PCB mountable
- Polarized housing assures proper mating
- Male and female terminals may be used in receptacle housing

Reference Information

Packaging: Bag
UL File No.: E29179
CSA File No.: LR19980
Mates With: Standard .062" plug
Use With: Standard .062" terminal
Designed In: Inches

Electrical

Voltage: 250V
Current: See chart
Dielectric Withstanding Voltage: 1500V AC rms

Mechanical

Contact Retention to Housing: 88.96N min.

Physical

Housing: Nylon, UL 94V-2
Operating Temperature: -40 to +105°C

Circuits	Series	Order No.		Amperes per Circuit
		Panel Mount	Free Hanging	
1	1625	N/A	03-06-1011	5.0
2		03-06-1022	03-06-1023	
3		03-06-1038	03-06-1032	
4 (1 x 4)		03-06-1041	03-06-1042	
4 (2 x 2)	2004	03-06-1043	03-06-1044	5.0
5	1625	03-06-1055	03-06-1056	
6		03-06-1061	03-06-1062	
9		03-06-1091	03-06-1092	
12		03-06-1121	03-06-1122	
15		03-06-6155	03-06-6152	
24		03-06-1241	N/A	
36*	1772	03-06-1361	03-06-1362	4.0

* 36-circuit receptacle is on a 4.19mm (.165") pitch

13 12 11 10 9 8 7 6 5 4 3 2 1

J
I
H
G
F
E
D
C
B
A

J
I
H
G
F
E
D
C
B
A

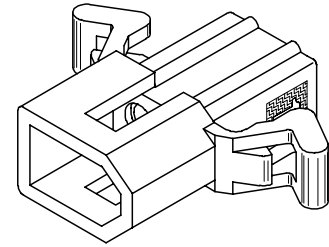
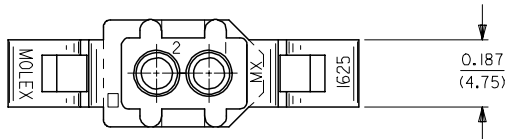

PLUG HOUSING

CIRCUIT I.D.

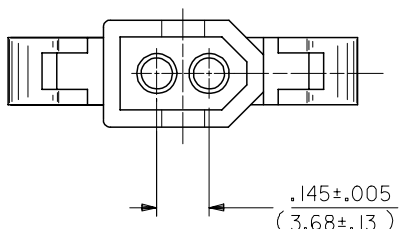
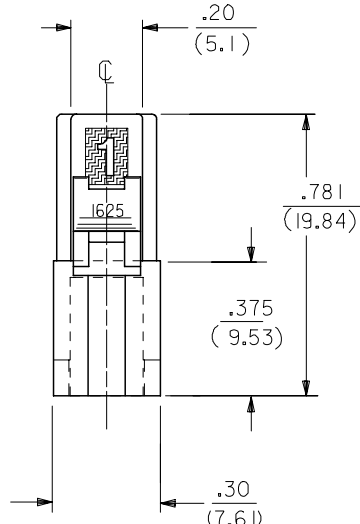
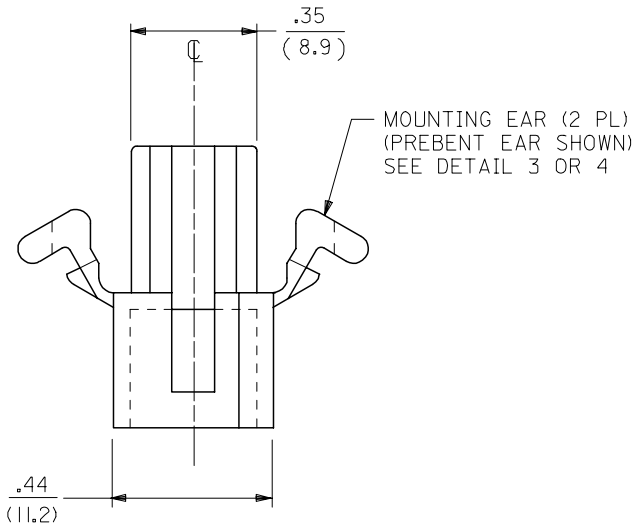
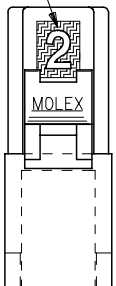

3	AE1
2	AE1
1	AE1
SHT.REV.	

ADD NEW TOOL STEP EC NO: UCP2007-1980 DRAWN/PRI/DDR 2007/04/13 CHKD: AEL/HAG 2007/04/16 APPR: FSM/TH 2007/04/19 REVISION AE1	QUALITY SYMBOLS 	GENERAL TOLERANCES (UNLESS SPECIFIED)		DIMENSION STYLE IN/MM		SCALE 4:1	DESIGN UNITS INCH	THIRD ANGLE PROJECTION			
		4 PLACES ± --- ± ---	4 PLACES ± --- ± ---	DRAWN BY JJS	DATE 1988/04/13	TITLE PLUG AND RECEPTACLE 2 CIRCUIT HOUSINGS .062/(1.57) DIA.					
		3 PLACES ± --- ± .007	3 PLACES ± --- ± .007	CHECKED BY RW	DATE 1988/04/13	MATERIAL NO. SEE CHART					
		2 PLACES ± 0.18 ± .010 1 PLACE ± 0.25 ± --- ANGULAR ± 1 °	2 PLACES ± 0.18 ± .010 1 PLACE ± 0.25 ± --- ANGULAR ± 1 °	APPROVED BY RAS	DATE 1988/04/13	MOLEX INCORPORATED		DOCUMENT NO. SD-1625-2*	SHEET NO. 1 OF 3		
DRAFT WHERE APPLICABLE MUST REMAIN WITHIN DIMENSIONS				SIZE C		THIS DRAWING CONTAINS INFORMATION THAT IS PROPRIETARY TO MOLEX INCORPORATED AND SHOULD NOT BE USED WITHOUT WRITTEN PERMISSION					

12 11 10 9 8 7 6 5 4 3 2 1

13 12 11 10 9 8 7 6 5 4 3 2 1

J
I
H
G
F
E
D
C
B
A

J
I
H
G
F
E
D
C
B
A

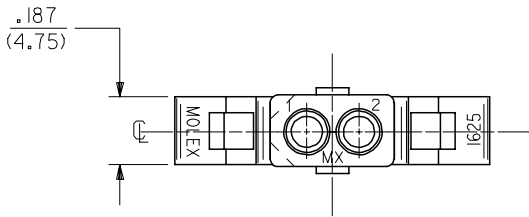

△ CIRCUIT I.D.

MOUNTING EAR (2 PL)
(WHEN SPECIFIED)
SEE DETAIL 3 OR 4

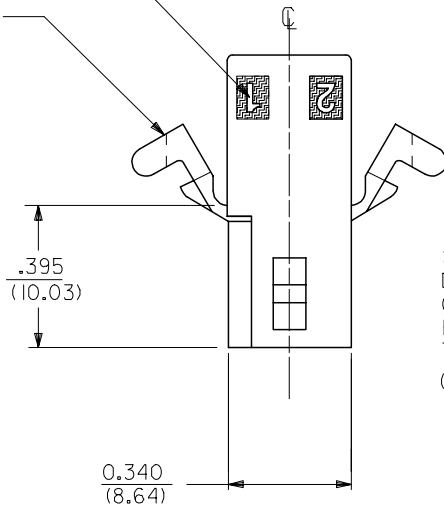

STANDARD
DETENT SHOWN.
OPTIONAL
POSITIVE LOCK
THIS SIDE ONLY
(SEE NOTE △5)

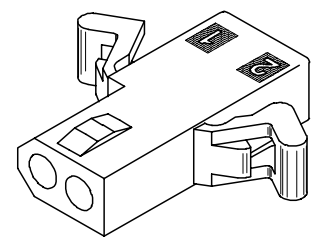
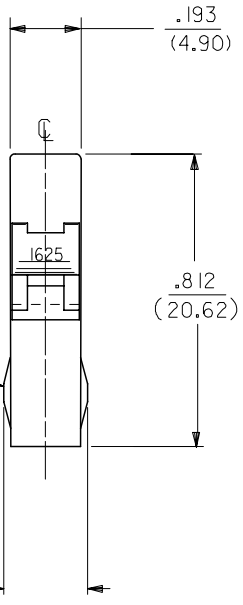

RECEPTACLE HOUSING
(1625-2R2 SHOWN)

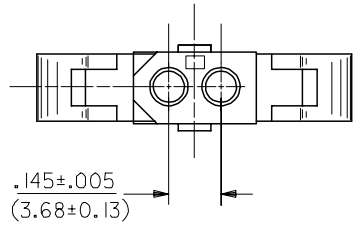

OPTIONAL POSITIVE LOCK
ONE SIDE ONLY
SCALE 4:1

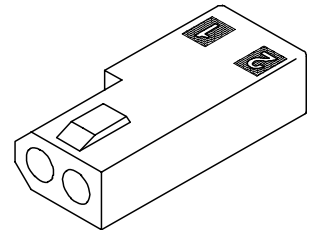

RECEPTACLE HOUSING
(1625-2R3 SHOWN)

UPDATE TITLE BLOCK EC NO: UCP2007-1980 DRAWN/PRI/DDR 2007/04/13 CHKD: AEL/HAG 2007/04/16 APPR: FSM/TH 2007/04/19 REV: AE1	QUALITY SYMBOLS ▽=0 ▽=0	GENERAL TOLERANCES (UNLESS SPECIFIED)		DIMENSION STYLE IN/MM		SCALE 4:1	DESIGN UNITS INCH	THIRD ANGLE PROJECTION			
		4 PLACES ± --- ± ---	3 PLACES ± --- ± .007	DRAWN BY JJS	DATE 1988/04/14	TITLE PLUG & RECEPTACLE 2 CIRCUIT HOUSINGS .062/(1.57) DIA.					
		2 PLACES ± 0.18 ± .010	1 PLACE ± 0.25 ± ---	CHECKED BY RW	DATE 1988/04/14	APPROVED BY RAS					
		ANGULAR ± 1 °		MATERIAL NO. SEE CHART		DOCUMENT NO. SD-1625-2*		SHEET NO. 2 OF 3			
DRAFT WHERE APPLICABLE MUST REMAIN WITHIN DIMENSIONS				THIS DRAWING CONTAINS INFORMATION THAT IS PROPRIETARY TO MOLEX INCORPORATED AND SHOULD NOT BE USED WITHOUT WRITTEN PERMISSION							

12 11 10 9 8 7 6 5 4 3 2 1

PLUG	
PART NO.	ENG. NO.
03-06-7023	I625-2PIBK
03-06-2023	I625-2P1
03-06-7027	I625-2P2BK
03-06-2024	I625-2P2

RECEPTACLE	
PART NO.	ENG. NO.
03-06-6023	I625-2RIBK
03-06-1020	I625-2R3
03-06-1023	I625-2R1
03-06-1022	I625-2R2
03-06-6025	I625-2R2RD
03-06-6026	I625-2R2GN
03-06-6027	I625-2R2BU
03-06-6022	I625-2R2BK
03-06-6028	I625-2R1BU

RECEPTACLE LEGEND:

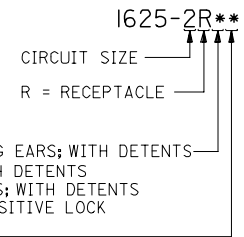

BLANK = WITH STANDARD MOUNTING EARS; WITH DETENTS
 1 = WITHOUT MOUNTING EARS; WITH DETENTS
 2 = WITH PREBENT MOUNTING EARS; WITH DETENTS
 3 = W/O MOUNTING EARS, WITH POSITIVE LOCK

BLANK = NATURAL
 AM=AMBER BK=BLACK BU=BLUE
 BN=BROWN GY=GRAY GN=GREEN
 OR=ORANGE RD=RED YW=YELLOW

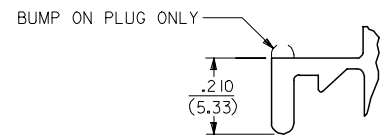

DETAIL 3
 STANDARD MOUNTING EARS
 (SCALE 4:1)

PLUG LEGEND:

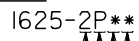

1 = WITHOUT MOUNTING EARS
 2 = WITH PREBENT MOUNTING EARS
 3 = W/O MOUNTING EARS, WITH POSITIVE LOCK

BLANK = NATURAL
 AM=AMBER BK=BLACK BU=BLUE
 BN=BROWN GY=GRAY GN=GREEN
 OR=ORANGE RD=RED YW=YELLOW

MAX. PANEL THICKNESS .060/(1.52)

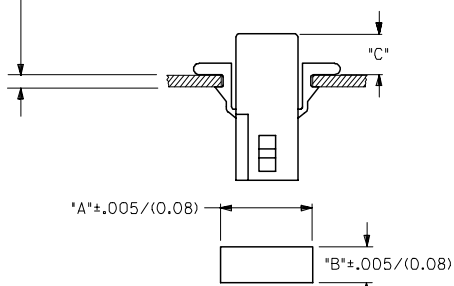

RECOMMENDED HOLE PATTERN

HOUSING	DIM. "A"	DIM. "B"	PREBENT EAR DIM. "C"	STD. EAR DIM. "C"
PLUG	.609 (15.47)	.318 (8.08)	.24 (6.0)	.24 (6.1)
RECEPTACLE	.505 (12.83)	.265 (6.73)	.25 (6.4)	.25 (6.4)

NOTES:

1. MATERIAL - NYLON TYPE 6/6, 94V-2
2. FINISH: NONE
3. PRODUCT SPECIFICATION: PS-02-06
4. PACKAGING SPECIFICATION: PK-1625-001
5. POSITIVE LOCK VERSION REQUIRES USE OF A SCREWDRIVER OR SIMILAR TOOL TO LIFT SHROUD ON PLUG HOUSING IN ORDER TO UNMATE RECEPTACLE HOUSINGS
6. HOUSINGS FOR USE WITH MOLEX .062/(1.57) DIA. SERIES TERMINALS.
7. CIRCUIT I.D. NUMBERS ON SIDE OF HOUSING APPEAR ON PARTS FROM TOOLS BUILT AFTER 07/01/1991.
8. THIS PART CONFORMS TO CLASS B REQUIREMENTS OF COSMETIC SPECIFICATION PS-45499-002.

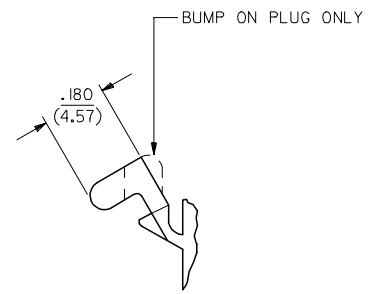

DETAIL 4

PREBENT MOUNTING EARS
 (SCALE 4:1)

UPDATE NOTES EC NO: UCP2007-1980 DRAWN: PPR/DDEE 2007/04/13 CHKD: AEL/HAG 2007/04/16 APPR: FSM/TH 2007/04/19 REVISIONS A1	QUALITY SYMBOLS ▽=0 ▽=0	GENERAL TOLERANCES (UNLESS SPECIFIED)		DIMENSION STYLE IN/MM		SCALE 2:1	DESIGN UNITS INCH	THIRD ANGLE PROJECTION	
		4 PLACES ± --- ± --- 3 PLACES ± --- ± .007 2 PLACES ± 0.18 ± .010 1 PLACE ± 0.25 ± --- ANGULAR ± 1 °	DRAWN BY JJS DATE 1988/04/14	TITLE PLUG & RECEPTACLE 2 CIRCUIT HOUSINGS .062(1.57)DIA.		SHEET NO. 3 OF 3			
		DRAFT WHERE APPLICABLE MUST REMAIN WITHIN DIMENSIONS		SEE CHART		MATERIAL NO. SD-1625-2*			
		THIS DRAWING CONTAINS INFORMATION THAT IS PROPRIETARY TO MOLEX INCORPORATED AND SHOULD NOT BE USED WITHOUT WRITTEN PERMISSION							



PRODUCT SPECIFICATION

.062 MINIATURE PIN TERMINALS

1.0 SCOPE

This specification covers the .062 diameter pin and socket terminal product line with their associated connector housings designed for use on copper wire.

2.0 PRODUCT DESCRIPTION

The product line described in general terms is found in catalog M200. The connector is made in 1, 2, 3, 4, 5, 6, 8, 9, 12, 15, 24 and 36 circuit sizes. Connector plugs and receptacles are nylon and provided with optional mounting ears for snap-in panel mounting. The housing accepts wire ranges 30 thru 18 AWG and insulation diameters of .040 thru .120 inches.

3.0 RECOGNIZED AGENCY APPROVALS

3.1 Underwriters' Laboratories: File #E29179.

3.2 Canadian Standards Association: File #LR 19980.

4.0 MECHANICAL SPECIFICATIONS

4.1 Materials, dimensions

<u>REVISION:</u> E	<u>ECR/ECN INFORMATION:</u> <u>EC No:</u> UCP2008-0413 <u>DATE:</u> 2007 / 09 / 05	<u>TITLE:</u> PRODUCT SPECIFICATION COMING CONNECTOR	<u>SHEET No.</u> 1 of 5
<u>DOCUMENT NUMBER:</u> PS-02-06	<u>CREATED / REVISED BY:</u> HM/MSIBARRA	<u>CHECKED BY:</u> DMORGAN	<u>APPROVED BY:</u> SMILLER



PRODUCT SPECIFICATION

4.1.1 Standard .062" molded nylon connectors .145 inch center to center spacings

Circuits (a)	1		2		3		4		4		5		6		8		9		12		15(b)		24		36(c)	
RECEPTACLE	1625-1		1625-2		1625-3		1625-4		2004		1625-5		1625-6		1649		1625-9		1625-12		1625-15		1625-24		1772	
	R	P	R	P	R	P	R	P	R	P	R	P	R	P	R	P	R	P	R	P	R	P	R	P	R	P
A	N/A	N/A	.265	.318	.265	.318	.260	.312	.400	.465	.265	.318	.505	.607	.330	N/A	.552	.615	.563	.614	.563	.614	.715	.765	.707	.825
B	N/A	N/A	.505	.609	.650	.754	.785	.865	.506	.615	.940	1.044	.552	.615	1.715	N/A	.650	.752	.795	.903	.934	1.042	1.079	1.182	1.677	1.795
C	N/A	N/A	N/A	.295	N/A	.295	.207	.292	N/A	.537	N/A	.305	N/A	.600	.310	.268	.530	.530	.530	.530	.527	.550	.665	.693	.855	.802
D	.781	.750	.781	.750	.781	.750	.781	.750	.750	.750	.781	.750	.781	.750	.781	.750	.781	.750	.781	.750	.781	.750	.750	.750	.781	.750
E	.192 Dia.	N/A	.192	.295	.192	.295	.192	.297	.339	.537	.192	.305	.494	.600	.220	.308	.494	.592	.489	.592	.487	.590	.634	.742	.689	.802
F	N/A	.298 Dia.	.340	.443	.485	.588	.630	.734	.339	.537	.775	.888	.344	.450	1.505	1.595	.489	.587	.634	.737	.770	.876	.918	1.027	1.508	1.618
G	N/A	N/A	.395	.375	.395	.375	.395	.375	.370	.350	.395	.375	.395	.375	.395	.375	.395	.375	.395	.375	.395	.375	.370	.350	.395	.375
H	N/A	N/A	.188	.188	.188	.188	.188	.188	.250	.250	.188	.188	.375	.375	.310	N/A	.375	.375	.375	.375	.375	.375	.500	.500	.625	.625
I	N/A	.200 Dia.	N/A	.348	N/A	.488	N/A	.635	N/A	.340	N/A	.780	N/A	.345	N/A	1.505	N/A	.490	N/A	.635	N/A	.774	N/A	.928	N/A	N/A
J	N/A	N/A	.21	.21	.21	.21	.21	.21	.21	.21	.21	.21	.21	.21	.21	.21	.21	.21	.21	.21	.21	.21	.21	.21	.21	.21

Available with strain relief 1815: Collar dia. .230" — Part 15-04-0201; .342" — Part 1504-0206; .280" — Part 15-04-0208.

Available with strain relief 1864: Collar dia. .415" — Part 15-04-0202; .500" — Part 15-04-0203. Dimensions C to J are included for reference only. Dimensions subject to nominal variations. N/A — Not available or not applicable.

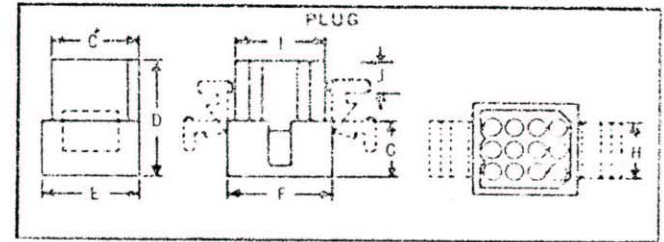
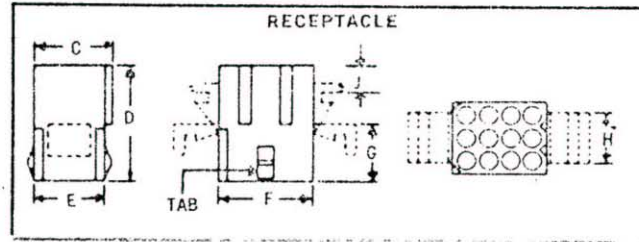
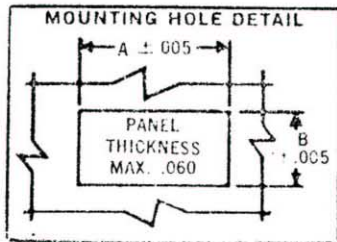

REVISION: E	ECR/ECN INFORMATION: EC No: UCP2008-0413 DATE: 2007 / 09 / 05	TITLE: PRODUCT SPECIFICATION COMING CONNECTOR	SHEET No. 2 of 5
DOCUMENT NUMBER: PS-02-06	CREATED / REVISED BY: HM/MSIBARRA	CHECKED BY: DMORGAN	APPROVED BY: SMILLER



PRODUCT SPECIFICATION

4.1.2 Terminals: Refer to sales drawing 02-06-* (SD-1560 Series)

4.2 Temperature Rise: Maximum Temperature rise is 30°C for all connector assemblies when used at their maximum rated current (Underwriters' Laboratories requirement).

4.3 Temperature:

4.3.1 Operating Temperature: -40°C to +105°C

4.3.2 Non-operating Temperature: -30°C to +60°C

4.4 Humidity

4.4.1 Test Method – exposure shall be 96 hours with a 95% to 100% relative humidity and a temperature of 100° ± 5% F. A one ampere current shall be placed through a male/female assembly within one hour after removing from the Humidity Chamber (18 AWG stranded wire).

4.4.2 Requirement – the maximum MV drop across both terminals shall be 15 MV. The probe should be placed on the wire approximately 1" from the crimp barrel.

4.5 Engage/Disengage forces for standard terminal (.008 stock 70/30 brass):

4.5.1 Plug and Receptacle Connector

AVG. SINGLE CIRCUIT FORCES:			
No. of Cycles	Engage		Disengage
1st	2.0 lbs.		1.8 lbs.
10th	1.3 lbs.		1.0 lbs.

<u>REVISION:</u> E	<u>ECR/ECN INFORMATION:</u> <u>EC No:</u> UCP2008-0413 <u>DATE:</u> 2007 / 09 / 05	<u>TITLE:</u> PRODUCT SPECIFICATION COMING CONNECTOR	<u>SHEET No.</u> 3 of 5
<u>DOCUMENT NUMBER:</u> PS-02-06		<u>CREATED / REVISED BY:</u> HM/MSIBARRA	<u>CHECKED BY:</u> DMORGAN
		<u>APPROVED BY:</u> SMILLER	



PRODUCT SPECIFICATION

4.5.2 Terminal Insertion and Retention in Connector Housing

	INSERTION	RETENTION
Male and Female	2.5 lbs.	20 lbs. min. using 18 AWG (by wire pull test method)

4.6 Terminal crimp strength – minimum pull out force in pounds is given in the following table for various wire sizes (AWG)

WIRE GAGE	18	20	22	24	26	28	30
PULL OUT FORCE (LBS.)	20	15	10	8	5	3	2

5.0 ELECTRICAL SPECIFICATIONS

5.1 Rated Voltage, currents

5.1.1 Initial resistance thru 2 adjacent terminals is 2 milliohms.

Circuits (a)	1	2	3	4	4	5	6	8	9	12	15(b)	24	36(c)
RECEPTACLE	1625-1	1625-2	1625-3	1625-4	2004	1625-5	1625-6	1649	1625-9	1625-12	1625-15	1625-24	1772
Max. Amp.	5	5	5	5	5	5	5	5	5	5	5	4	4
Max. Volts	250	250	250	250	250	250	250	250	250	250	250	250	250
Holding Tabs Only	03-06-1011	03-06-1023	03-06-1032	03-06-1042	03-06-1044	03-06-1056	03-06-1062	N/A	03-06-1092	03-06-1122	03-06-1152	03-06-1242	03-06-1362
WITH EARS AND TABS	N/A	03-06-1022	03-06-1031	03-06-1041	03-06-1043	03-06-1055	03-06-1061	03-06-1081	03-06-1091	03-06-1121	03-06-1151	03-06-1241	03-06-1361

PLUG 212

Max. Amp	5	5	5	5	5	5	5	5	5	5	5	4	4
Max. Volts	250	250	250	250	250	250	250	250	250	250	250	250	250
With Mounting Ears Only	N/A	03-06-2022	03-06-2031	03-06-2041	03-06-2043	03-06-2054	03-05-2062	N/A	03-06-2091	03-06-2121	03-06-2151	03-06-2241	03-06-2361
Without Mounting Ears	03-06-2011	03-06-2023	03-06-2032	03-06-2042	03-06-2044	03-06-2055	03-06-2061	03-06-2081	03-06-2092	03-06-2122	03-06-2152	03-06-2242	03-06-2362

REVISION:

E

ECR/ECN INFORMATION:

EC No: UCP2008-0413

DATE: 2007 / 09 / 05

TITLE:

**PRODUCT SPECIFICATION
COMING CONNECTOR**

SHEET No.

4 of 5

DOCUMENT NUMBER:

PS-02-06

CREATED / REVISED BY:

HM/MSIBARRA

CHECKED BY:

DMORGAN

APPROVED BY:

SMILLER



PRODUCT SPECIFICATION

5.1.2 Initial resistance thru 3 interconnected terminals is 3 milliohms.

5.1.3 Initial resistance thru 15 interconnected terminals is 15 milliohms.

5.1.4 After Humidity Cycling per Mil. Std. 202E. Method 106C or 96 hours @ 120 C oven aging, terminal resistance change shall not exceed 2.0 times the initial values.

5.2 Terminal resistance (voltage drop measured at one amp) (18AWG stranded wire).

- 1) 1st Terminal Engagement 3.2 MV \pm 10%
- 2) 10th Terminal Engagement 3.4 MV \pm 10%

The above voltage is measured across the friction connection of pin. The voltage drop is approximately 1 MV greater when including the mated terminals plus both crimps. In this case the probes should be placed on the wire approximately 1" from the crimp barrel.

5.3 High Voltage Test

Terminals mounted in a connector must withstand 1500 volts RMS applied between adjacent terminals for 60 seconds without breakdown.

6.0 REFERENCE

QC spec M-50-003

<u>REVISION:</u> E	<u>ECR/ECN INFORMATION:</u> <u>EC No:</u> UCP2008-0413 <u>DATE:</u> 2007 / 09 / 05	<u>TITLE:</u> PRODUCT SPECIFICATION COMING CONNECTOR	<u>SHEET No.</u> 5 of 5
<u>DOCUMENT NUMBER:</u> PS-02-06	<u>CREATED / REVISED BY:</u> HM/MSIBARRA	<u>CHECKED BY:</u> DMORGAN	<u>APPROVED BY:</u> SMILLER