

RECEPTACLE

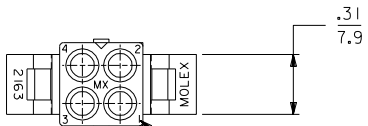

CIRCUIT NUMBERS

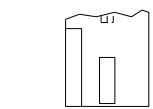
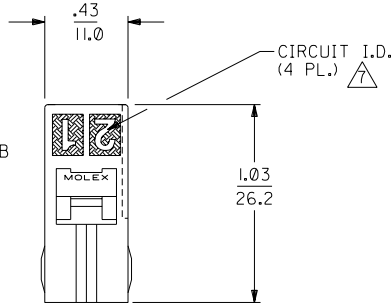
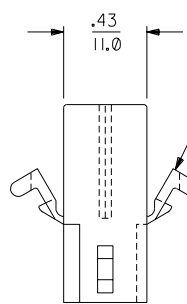

8

OPTIONAL POSITIVE LOCK
(ONE SIDE ONLY)

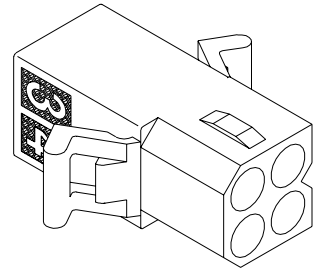
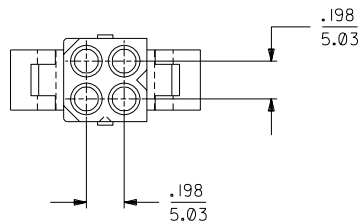

SHOWN WITH PREBENT MOUNTING EAR

PLUG

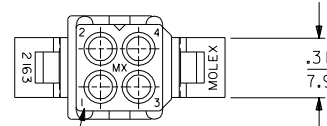

CIRCUIT NUMBERS

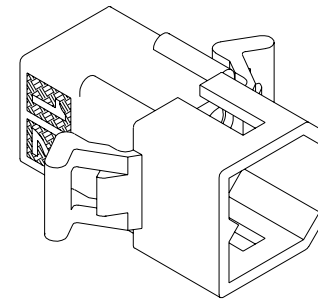
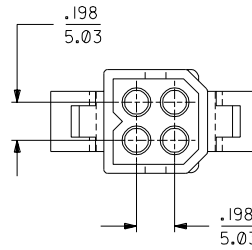
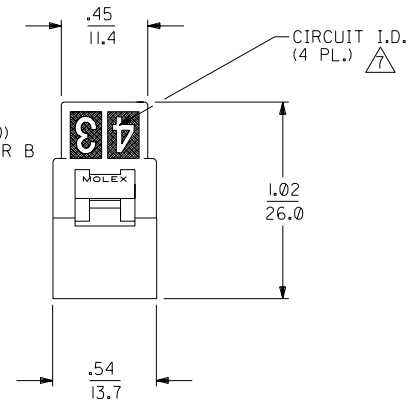
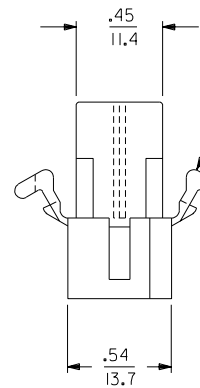

SHOWN WITH PREBENT MOUNTING EAR

II	ADD -PIUV & -RIUV UCR2003-1992 ELHAG, 03/03/20
I	OBsolete P/N UCR2002-0270 COMERC1 01/10/1
HI	UPDATE PER UCR2001-0387 JBS 10/25/00 BW
H	ADD -R3 & -R4 ECN #1998-0037 RW 3-17-98
G	REVISED ECN U81435 WANG 98-01-09
FI	REVISED ECN U81083 WANG 97/10/29
F	REMOVE -PBK ECR # U81652 CWC 3/30/93 RW
E	ADD CIRCUIT NO'S. ECR U11666 CWC 7/22/91 RW

MFG.	2	II	
SH.	I	II	
REV.			
LTR.			
REVISIONS			

DIMENSIONS SHOWN (METRIC) INCH
UNLESS OTHERWISE SPECIFIED
TOLERANCES: ANGULAR ± .008°

	INCH	METRIC
3 PLACE	± .010	---
2 PLACE	± .014	± 0.25
1 PLACE	---	± 0.35

DRAFT WHERE APPLICABLE MUST REMAIN WITHIN DIMENSIONS

REVISIONS ONLY ON CAD SYSTEM

TITLE: .093/(2.36) HOUSINGS
PLUG & RECEPTACLE
4 CIRCUIT, .198/(5.03) ⌀

MOLEX INCORPORATED U.S.A. SHEET NO. 1 OF 2 DATE 2/ 3/89

PART NO. 60532 DRWG. NO. SD-2163-*

SEE CHART

DRWG. BY: KBW CHK'D BY: RW
APPR'D BY: RAS SCALE: 2:1

FILE NAME: M21634-302

THIS DRAWING CONTAINS INFORMATION THAT IS PROPRIETARY TO MOLEX INC. AND SHOULD NOT BE USED WITHOUT WRITTEN PERMISSION

PLUG	
ORDER NO	ENG NO
03-09-2040	2163-P
03-09-2049	2163-PI
03-09-2019	2163-PIRD
03-09-2029	2163-PIBU
50-29-0097	2163-PIUV

RECEPTACLE		
ORDER NO	ENG NO	
03-09-1040	2163-R	
03-09-1049	2163-R1	
03-09-6049	2163-RIBK	
03-09-1044	2163-R3	OBSOLETE
03-09-1050	2163-R4	OBSOLETE
03-09-2071	2163-RIRD	
03-09-2072	2163-RIBU	
50-29-0098	2163-RIUUV	

LEGEND:

2163-****

P = PLUG
R = RECEPTACLE

BLANK = WITH STANDARD EARS
 1 = WITHOUT EARS
 2 = WITH PREBENT EARS
 3 = RECEPTACLE W/ POSITIVE LOCK RAMP, WITHOUT EARS.
 4 = RECEPTACLE W/ POSITIVE LOCK RAMP, WITH STANDARD EARS.

COLOR:

BLANK = NATURAL COLOR
 AM = AMBER BK = BLACK BU = BLUE
 BN = BROWN GY = GRAY GN = GREEN
 OR = ORANGE RD = RED YW = YELLOW
 UV = BLACK UV RESISTANT

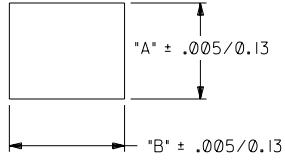
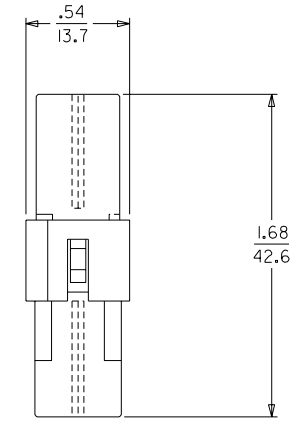
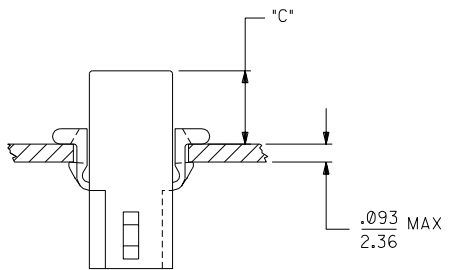

RECOMMENDED PANEL OPENING

HOUSING	DIM. "A"	DIM. "B"	"C" PREBENT EAR	"C" STANDARD EAR
PLUG	.555/14.10	.695/17.65	.42/10.7	.38/9.7
RECEPT.	.500/12.70	.600/15.24	.40/10.2	.37/9.4

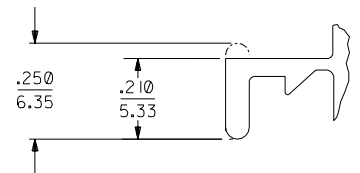

DETAIL A

.093/(2.36) STANDARD MOUNTING EAR
(SCALE 4:1)

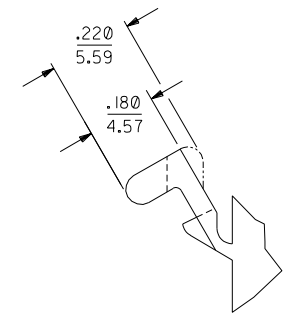

DETAIL B

.093/(2.36) PREBENT MOUNTING EAR
(SCALE 4:1)

NOTES:

- MATERIAL: NYLON 6/6 (PA), UL 94V-2.
- FINISH: NONE.
- PRODUCT SPECIFICATION: PS-02-09 APPLIES.
- PACKAGING SPECIFICATION: PK-70810-7018.
- MATES WITH: SERIES 2163.
- ACCEPTS MOLEX .093 SERIES TERMINALS.
- CIRCUIT I.D. NUMBERS ON HOUSING APPEAR ON PARTS FROM TOOLS BUILT AFTER 7/22/91.
- POSITIVE LOCK VERSION REQUIRES USE OF A SCREWDRIVER OR SIMILAR TOOL TO LIFT SHROUD ON PLUG HOUSING IN ORDER TO UNMATE RECEPTACLE HOUSING.

REV.	DATE	BY	CHK'D.	REVISIONS
11		SEE SHEET 1	E	SEE SHEET 1
I		SEE SHEET 1	D	SEE SHEET 1
LTR.		REVISIONS	LTR.	REVISIONS

DIMENSIONS SHOWN (METRIC INCH)	
UNLESS OTHERWISE SPECIFIED TOLERANCES: ANGULAR ± DMS	
5 PLACE ± .010	---
2 PLACE ± .014	± 0.25
1 PLACE ---	± 0.35
DRAFT WHERE APPLICABLE MUST REMAIN WITHIN DIMENSIONS	
DRWG. BY: KBW	CHK'D. BY: RW
APP'D. BY: RAS	SCALE: 2 : 1

▽ = 0	▼ = 0	REVISE ONLY ON CAD SYSTEM
TITLE: .093/(2.36) HOUSINGS PLUG & RECEPTACLE 4 CIRCUIT, 198/(5.03) C		
MOLEX INCORPORATED U.S.A.		SHEET NO. 2 DATE 02/03/99
PART NO. SD-2163-*		DRWG. NO.
SEE CHART		
FILE NAME: M21634	THIS DRAWING CONTAINS INFORMATION THAT IS PROPRIETARY TO MOLEX INC. AND SHOULD NOT BE USED WITHOUT WRITTEN PERMISSION.	DIV. CP