



# **HDAC .64 User Manual**

## **Connector Assembly Reference Manual**

**REV 1 – May 9, 2006**

# Table of Contents

- **Section 1: Product Introduction**
- **Section 2: Product Summary**
- **Section 3: Connector Assembly**
- **Section 4: Connector Mating**
- **Section 5: Service Instructions**



# Product Introduction

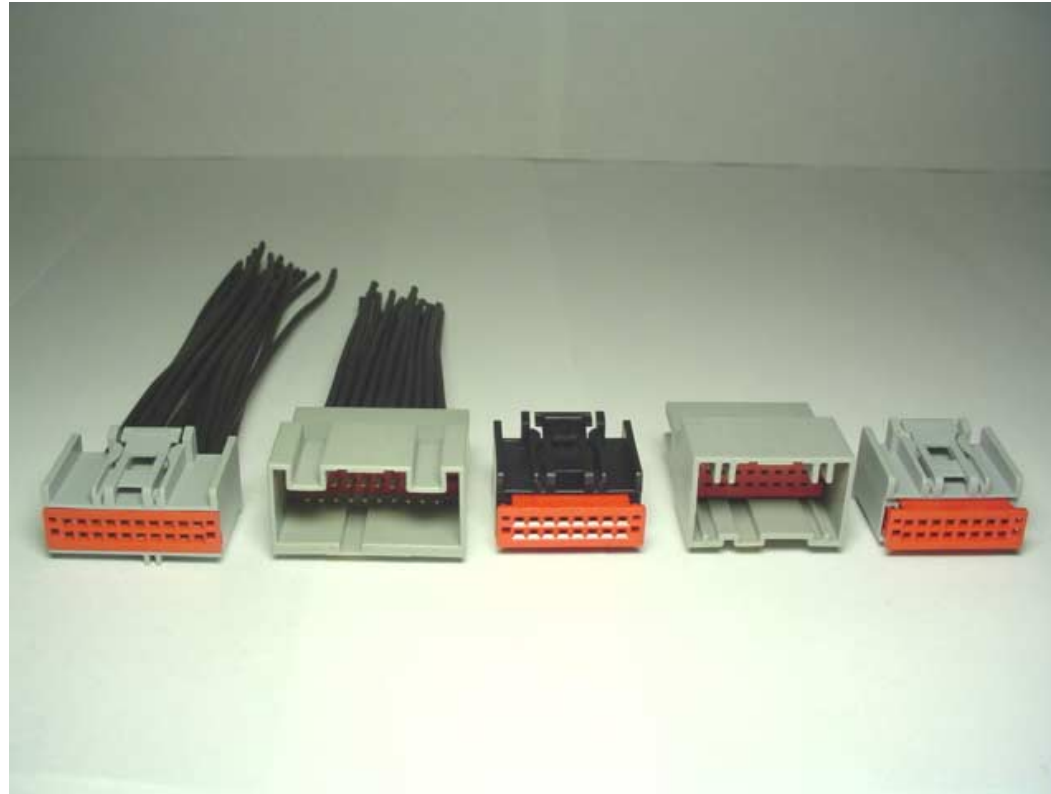

## HDAC 0.64 Product Line



# Section 1: Product Introduction

**This instructions manual contains supplemental information pertaining to the Molex HDAC 0.64 Product Line.**

**For product ordering information, please contact your Molex Inside Sales Representative at (800)786-6539.**

**For electronic copies and future updates of this document, and the Connector Reference Manual, refer to the Molex Website at <http://www.molex.com>**



# Section 2: Product Summary

## A. Connector Assemblies

HDAC 0.64 Receptacle Connector Assembly

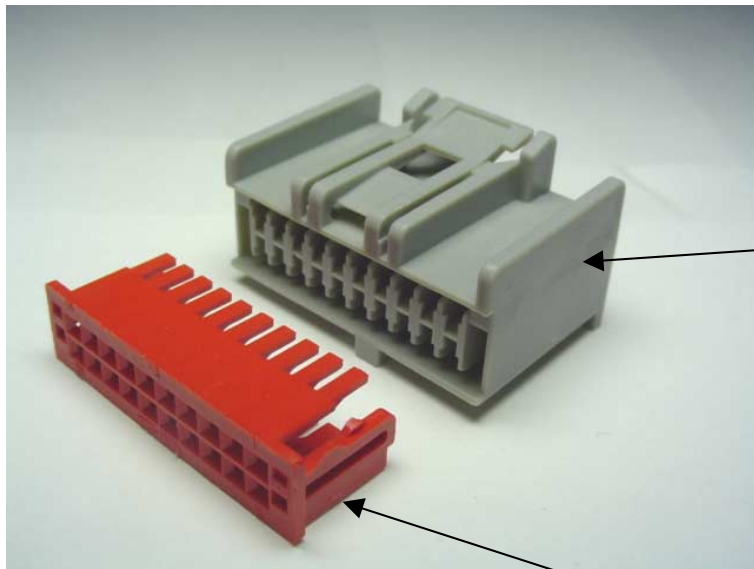

HDAC 0.64 Blade Connector Assembly

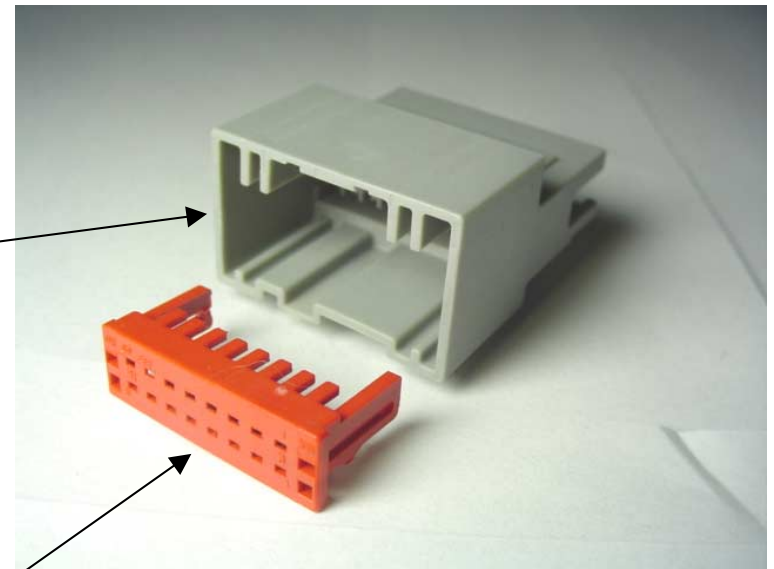

Housing

TPA



# Section 2: Product Summary

- **TYCO Blade Terminal**
  - **Base Material**
    - ✓ Copper Alloy
  - **Plating Options**
    - ✓ Tin, Gold
  - **Wire Sizes:**
    - ✓ 16,18,20,22 AWG



- **Molex Receptacle Terminal**
- **PN 34083-3001**
  - **Base Material**
    - ✓ Copper Alloy
  - **Plating Options**
    - ✓ Tin, Gold
  - **Wire Sizes:**
    - ✓ 16,18,20,22 AWG

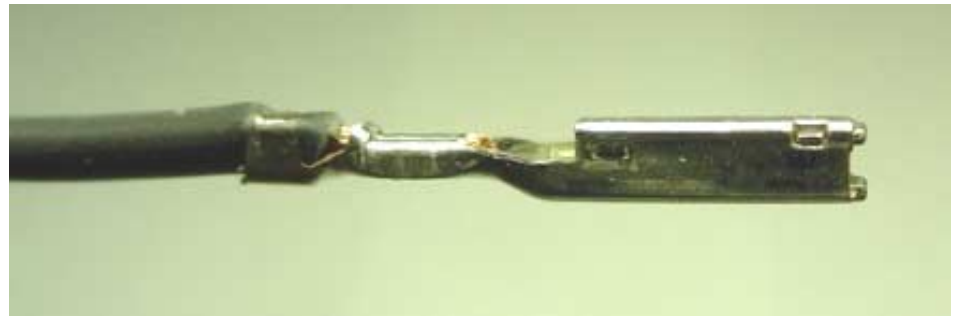

# Section 3: Connector Assembly

## A. Connectors shown in “As Shipped” Connector Position

TPA's shown in “as shipped” condition (pre-lock).

The TPA must remain in the pre-lock position until all circuits are loaded.

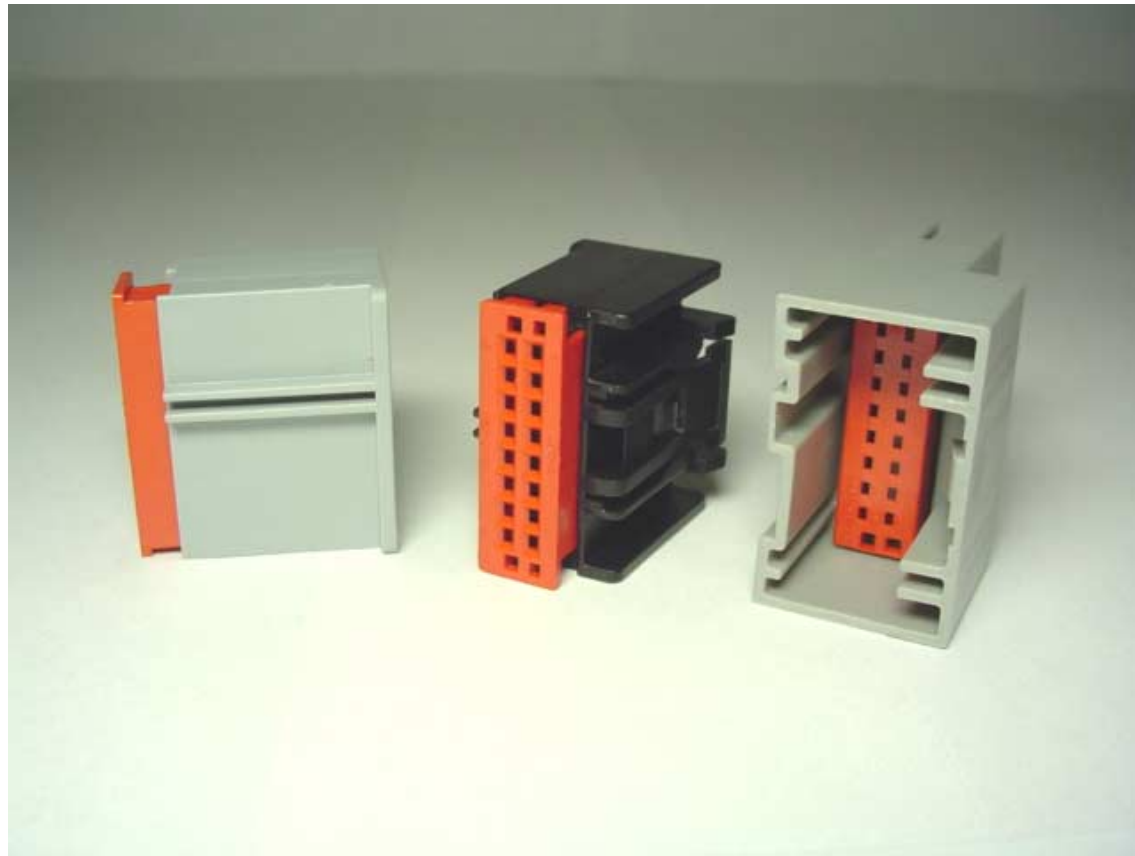

# Section 3: Connector Assembly

## B. Terminal Installation:

With TPA still in pre-lock position, orient terminal to rear of connector as shown below.

Grip the wire no less than 1.25 inches from the terminal insulation crimp and insert through appropriate circuit opening.

If resistance is encountered, retract the terminal and adjust the angle of insertion.

Continue inserting the terminal until it stops and locks up on the lock finger with an audible click.

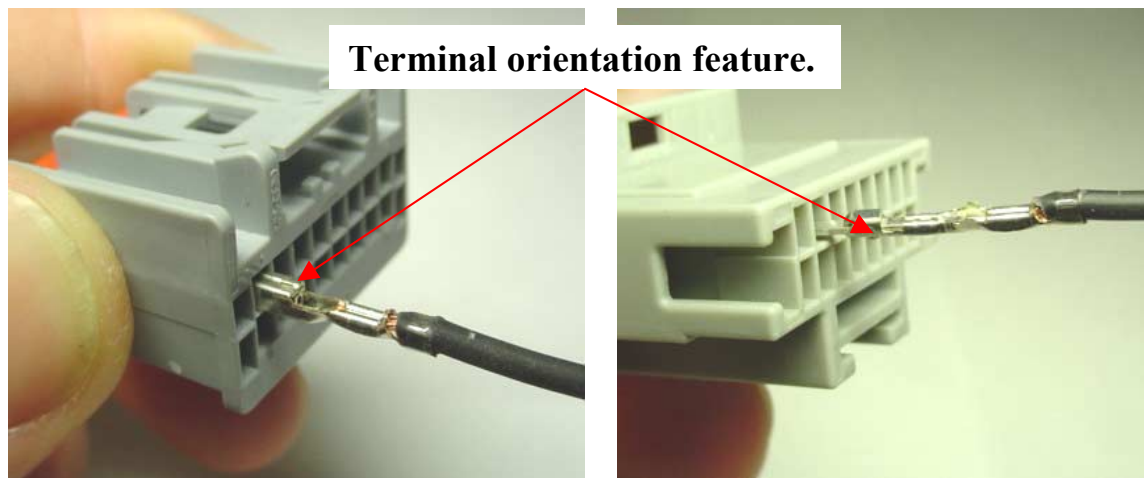

Correct Orientation

Correct Orientation

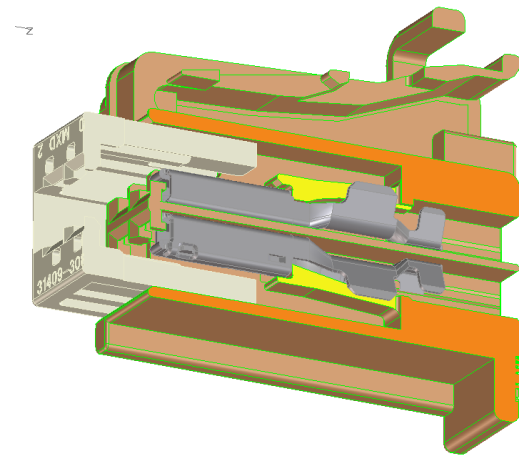

Cross section of proper installation





# Section 3: Connector Assembly

## C. Seating the TPA

With the receptacle terminals fully installed, the TPA can be seated into its final lock position by applying an even force to the TPA surface until it comes to a stop, with an audible click.

With the blade terminals fully installed, the TPA can be seated into its final lock position by applying an even force to the TPA surface until it comes to a stop, with an audible click.

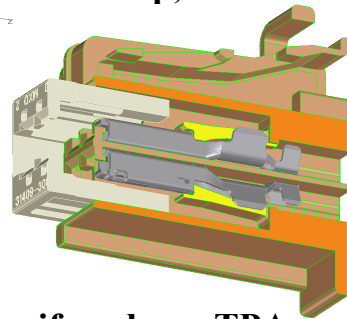
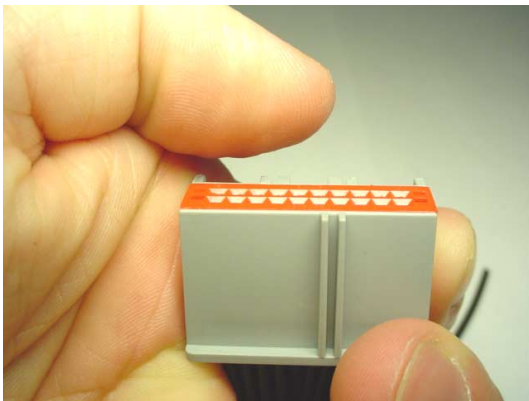
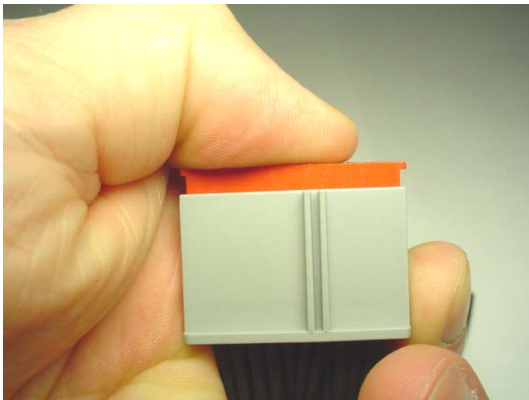

**Push uniformly on TPA main surface only to fully seat – being careful not to touch the blade terminals. It is recommended that a non-metal tool is use to seat the TPA. This will limit the possibility of damaging the blade terminals.**

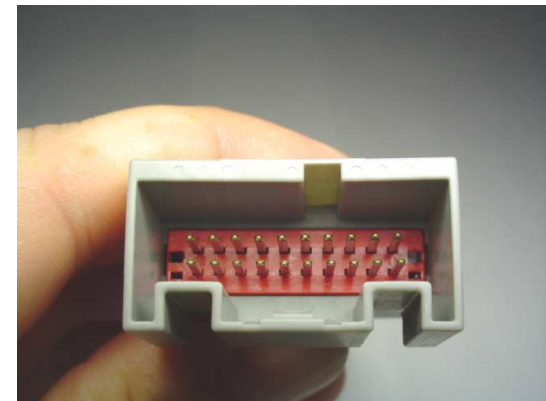
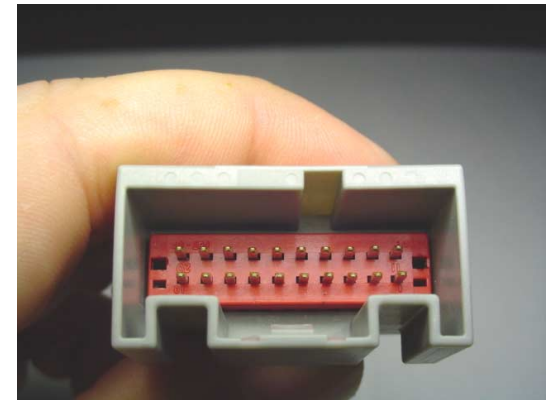
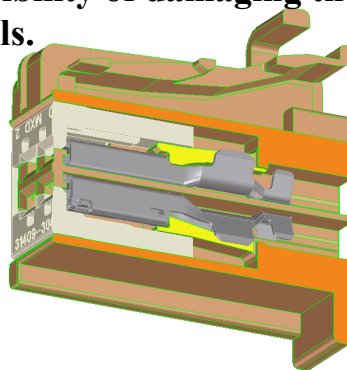

# Section 4: Connector Mating

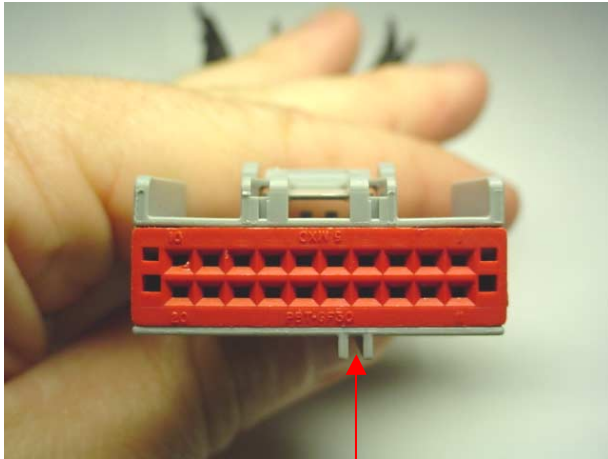

Keying Features

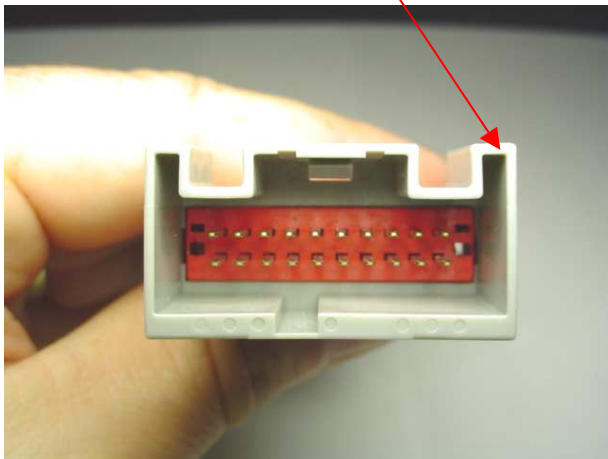

Note and align connector keying features, from receptacle connector to blade connector.

Begin mating procedure by sliding the receptacle connector assembly and blade connector assembly together, press firmly until you hear an audible click.

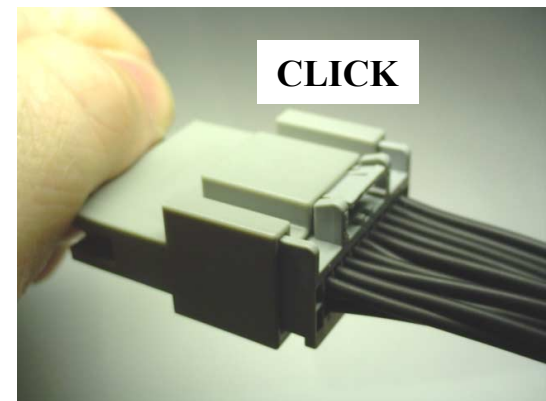
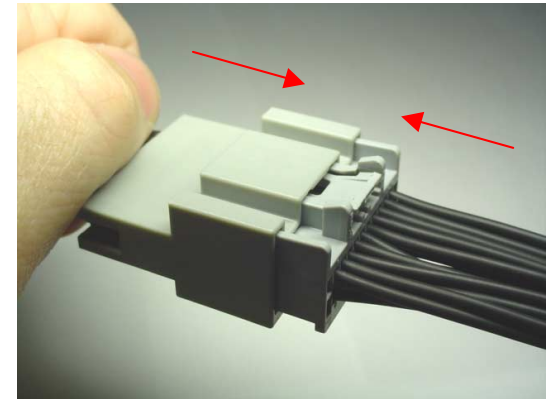
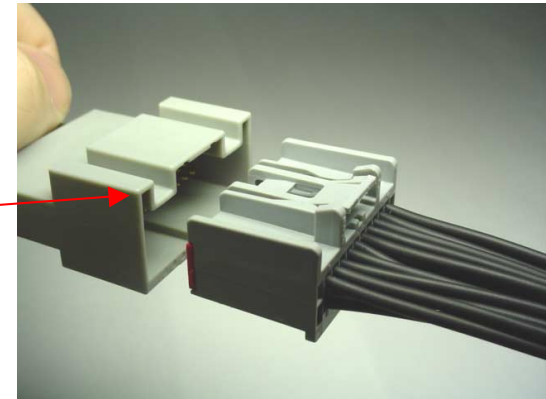

# Section 5: Service Instructions

## A. Un-mate procedure

To un-mate the connectors, push connector together to unload the latch system.

Then depress the latch with your thumb (step 1). Continue to depress the latch, and gently pull apart connector assemblies (step2).

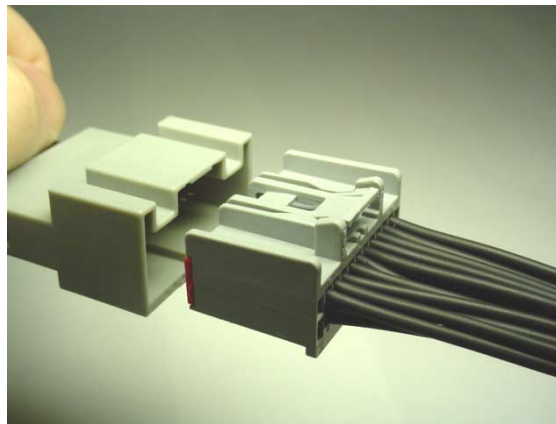
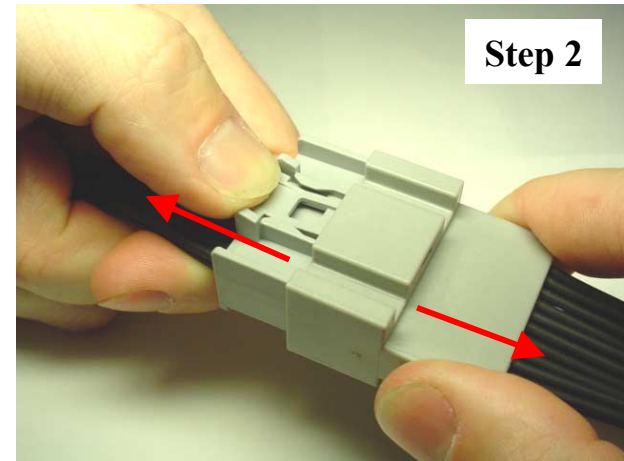
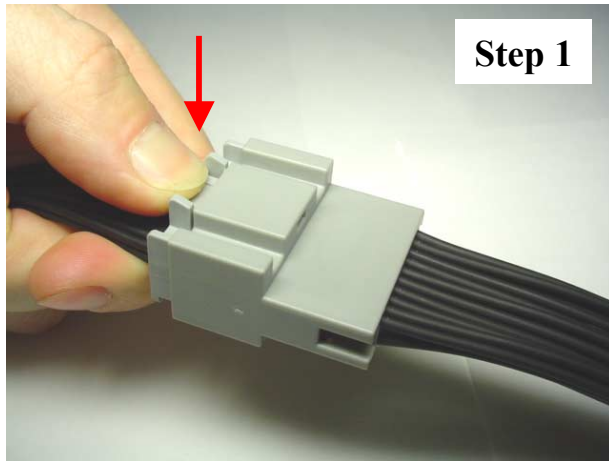

# Section 5: Service Instructions

## B. TPA Servicing Receptacle

**Step 1:** Insert a small screwdriver, or service tool (max width = 2.0 mm) into the designated pry point.

**Step 2:** Using the housing as a pivot point gently push out on the TPA until it is removed from the connector housing. **If TPA is damaged, Do Not Reuse! Excessive force may damage the TPA!**

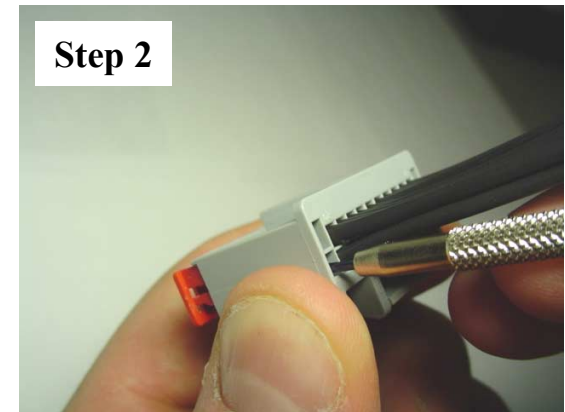
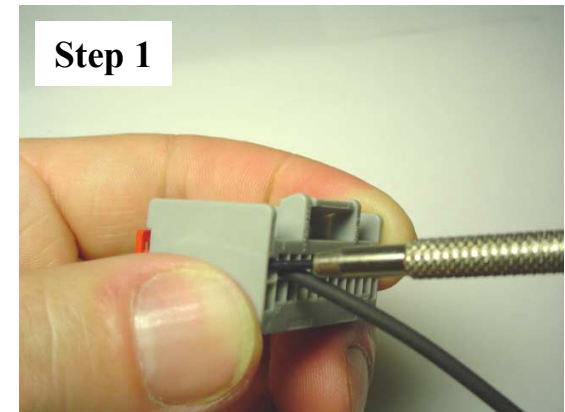
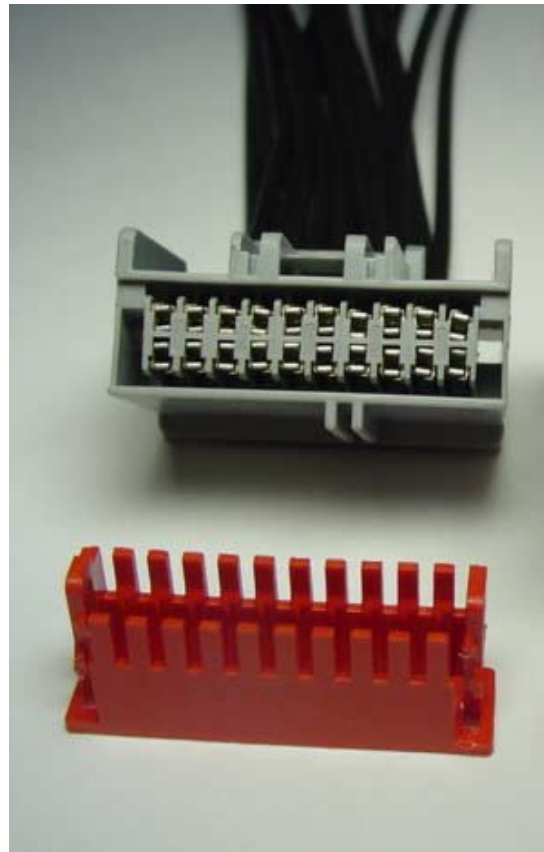
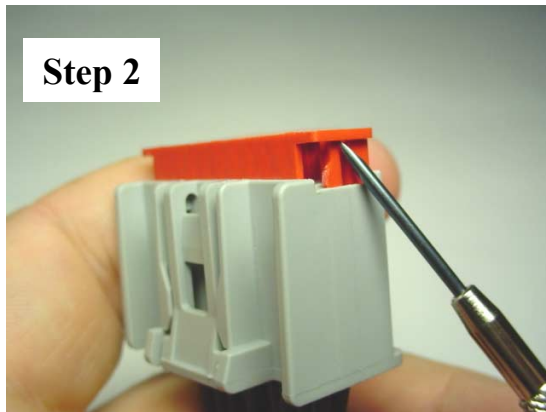
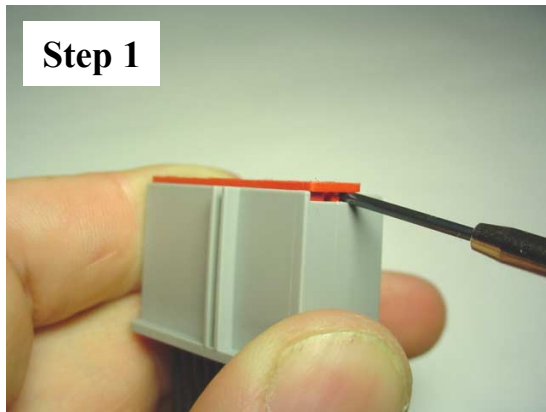

# Section 5: Service Instructions

## C. TPA servicing the Blade connector

**Step 1:** Insert a small screwdriver into the two small extraction holes

**Step 2:** Push on opposite sides of the TPA latch until it is removed from the connector housing.

**If TPA is damaged, Do Not Reuse! Excessive force may damage the TPA!**

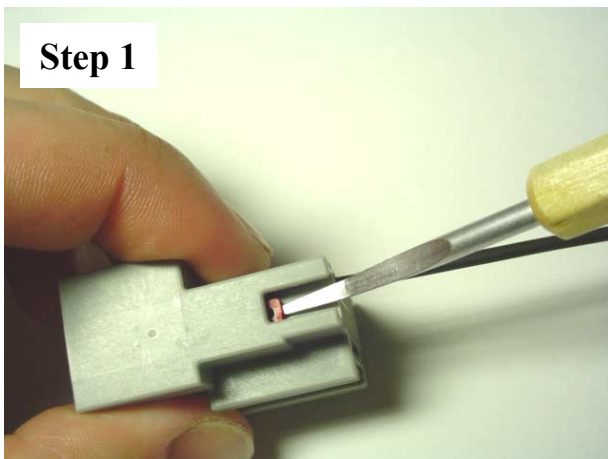

Un-damaged TPA after removal

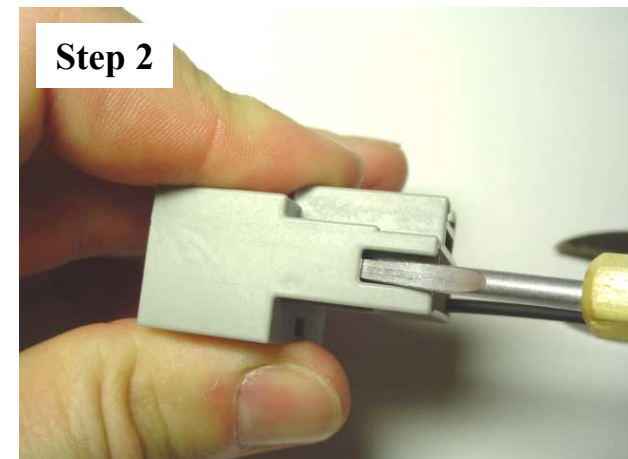

# Section 5: Service Instructions

## D. Terminal removal (continued)

Step 3: Service tool should not be more than 2.0 mm wide.

Using the designated service tool, disengage the terminal lock finger.

Once the Lock finger is disengaged, gently pull on the wire to release the terminal.

If the terminal resists, the service tool may not be fully engaged. Gently push the service tool further into the terminal lock finger to ensure that it has fully disengaged.

**Do not insert the service tool into the terminal opening!**

**Do not use excessive force, excessive force can damage the lock finger!**

