

VIEW SHOWN WITH TPA
IN LOCKED POSITION

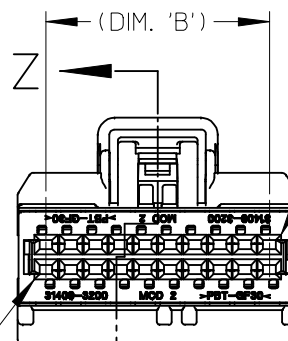

FRONT VIEW

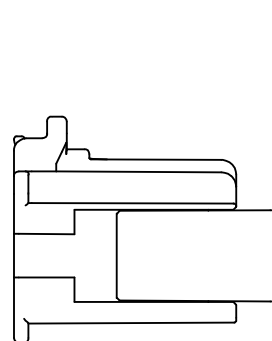
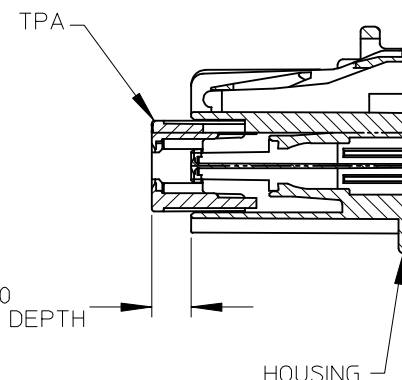

SECTION Z-Z

NOTES:

1. MATERIALS:

HOUSING: SPS/PA66 BLEND, 30% GF
TPA: PBT, GF
COLOR: NATURAL (CREAM)

2. PACKAGING INFORMATION: PK-31300-044

3. MATING COMPONENTS:

NEW APPLICATIONS:

REFER TO SD-34691-100 & SD-34690-100

EXISTING APPLICATIONS (RESTRICTED):

REFER TO SD-31429-700 & SD-31411-700

4. TPA's MAY BECOME SEATED DURING TRANSIT. IF THIS OCCURS, REFERENCE MOLEX PRODUCT SPECIFICATION PS-34646-001.

5. TO BE USED WITH TYCO TERMINAL: 18/20 AWG 1393366-1
22 AWG 1393367-1

EC NO: UAU2008-0100 DRWN:BDICK01 2008/08/22 CHKD: 2008/08/28 APPR:SMARCEAZ08/08/28 G	QUALITY SYMBOLS	GENERAL TOLERANCES (UNLESS SPECIFIED)	SCALE 2:1	DESIGN UNITS METRIC	THIRD ANGLE PROJECTION	REVISE ON CAD ONLY
	▼ = 0 ▽ = 0	mm INCH	DIMENSION STYLE MM ONLY		TITLE	
		4 PLACES ± --- ± --- 3 PLACES ± --- ± --- 2 PLACES ± 0.13 ± --- 1 PLACE ± 0.25 ± --- ANGULAR ± 3°	DRAWN BY SKAROLEW DATE 2004/02/17		USCAR 0.64MM RECEPTACLE ASSY, GET TERMINAL SALES DRAWING	
	DESCRIPTION	DRAFT WHERE APPLICABLE MUST REMAIN WITHIN DIMENSIONS	APPROVED BY BBWILSON DATE 2004/04/06	CHECKED BY MDANIELS DATE 2004/03/31	MOLEX MOLEX INCORPORATED SEE CHART SD-31408-900	
REV		THIS DRAWING CONTAINS INFORMATION THAT IS PROPRIETARY TO MOLEX INCORPORATED AND SHOULD NOT BE USED WITHOUT WRITTEN PERMISSION		MATERIAL NO.	DOCUMENT NO.	SHEET NO.
				SEE CHART	SD-31408-900	1 OF 3

10 9 8 7 6 5 4 3 2 31408

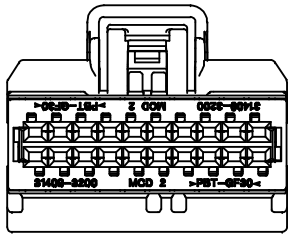

20 WAY

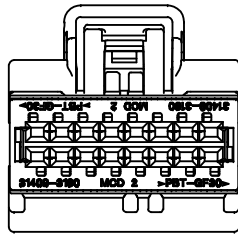

16 WAY

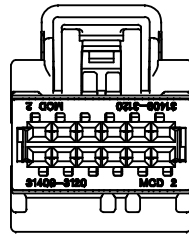

12 WAY

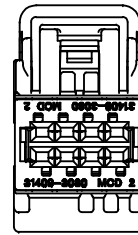

8 WAY

POLARIZATION 'A' OPTION
(ALL CIRCUITS SHOWN)

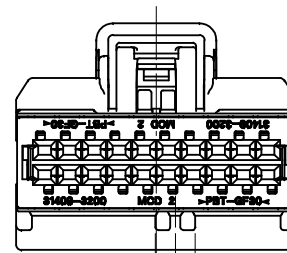

POLARIZATION 'A'

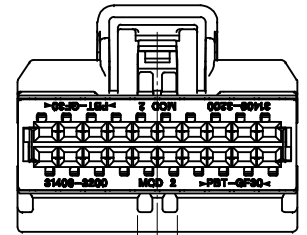

POLARIZATION 'B'

(4.06)
(1.95)

(4.06)

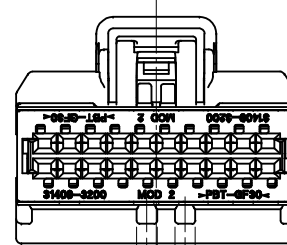

POLARIZATION 'C'

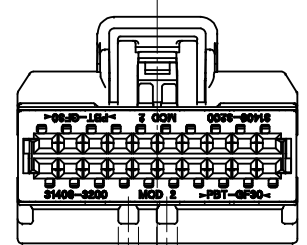

POLARIZATION 'D'

(2.11)
(2.05)
(2.96)
(0.97)

(2.11)
(2.05)
(2.96)
(0.97)

POLARIZATION OPTIONS
(20-CIRCUIT SHOWN)

EC NO: UAU2008-0100 DRWN:BDICK01 2008/08/22 CHKD: 2008/08/28 APPR: SWARCEAU2008/08/28	QUALITY SYMBOLS ▽ - 0 ▽ - 0	GENERAL TOLERANCES (UNLESS SPECIFIED)		SCALE 2:1	DESIGN UNITS METRIC	THIRD ANGLE PROJECTION	REVISE ON CAD ONLY
		mm INCH	DIMENSION STYLE MM ONLY		TITLE USCAR 0.64MM RECEPTACLE ASSY, GET TERMINAL SALES DRAWING		
		4 PLACES ± --- ± --- 3 PLACES ± --- ± --- 2 PLACES ± 0.13 ± --- 1 PLACE ± 0.25 ± ---	DRAWN BY SKAROLEW	DATE 2004/02/17	MOLEX INCORPORATED		
		ANGULAR ± 3 ° DRAFT WHERE APPLICABLE MUST REMAIN WITHIN DIMENSIONS	CHECKED BY MDANIELS	DATE 2004/03/31	MATERIAL NO. SEE CHART	DOCUMENT NO. SD-31408-900	SHEET NO. 2 OF 3

MOLEX ASSY. P/N	CIRCUITS	DIM. 'A'	(DIM. 'B')	(DIM. 'C')	POLARIZATION	HOUSING COLOR
31408-1080	8	13.40	(7.62)	(29.7)	A	BLACK
31408-1081					B	GRAY
31408-1082					C	BROWN
31408-1120	12	18.48	(12.70)	(31.3)	A	BLACK
31408-1121					B	GRAY
31408-1122					C	BROWN
31408-1160	16	23.56	(17.78)	(33.5)	A	BLACK
31408-1161					B	GRAY
31408-1162					C	BROWN
31408-1200	20	28.64	(22.86)	(36.3)	A	BLACK
31408-1201					B	GRAY
31408-1202					C	BROWN
31408-1203					D	GREEN



RECYCLE CODE
 P/N SERIES NO.
 MANU. LOC./CAV. ID

DETAIL Y
 SCALE 4:1

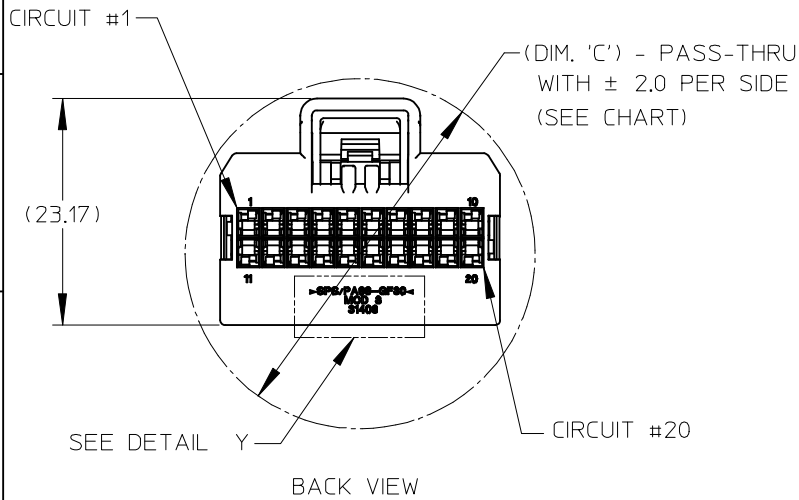

EC NO: UAU2008-0100 IDRN:BDICK01 2008/08/22 CHKD: 2008/08/28 APPR: SMARCEA2008/08/28	QUALITY SYMBOLS	GENERAL TOLERANCES (UNLESS SPECIFIED)	SCALE 2:1	DESIGN UNITS METRIC	THIRD ANGLE PROJECTION	REVISE ON CAD ONLY
	▼ - 0 ∇ - 0	mm INCH 4 PLACES ± --- ± --- 3 PLACES ± --- ± --- 2 PLACES ± 0.13 ± --- 1 PLACE ± 0.25 ± --- ANGULAR ± 3°	DIMENSION STYLE MM ONLY	DRAWN BY SKAROLEW DATE 2004/02/17	CHECKED BY MDANIELS DATE 2004/03/31	TITLE USCAR 0.64MM RECEPTACLE ASSY, GET TERMINAL SALES DRAWING
G	DESCRIPTION	DRAFT WHERE APPLICABLE MUST REMAIN WITHIN DIMENSIONS	APPROVED BY BBWILSON DATE 2004/04/06	MATERIAL NO. SEE CHART	DOCUMENT NO. SD-31408-900	SHEET NO. 3 OF 3
THIS DRAWING CONTAINS INFORMATION THAT IS PROPRIETARY TO MOLEX INCORPORATED AND SHOULD NOT BE USED WITHOUT WRITTEN PERMISSION						MOLEX INCORPORATED