

RoHS COMPLIANT

ENTER DESCRIPTION IEC NO: 2012-0253 DRAWN: VITTHAR 2012/02/14 CHKD: APPR: KPRASAD REV: 2012/02/15	QUALITY SYMBOLS ▽=0 ▽=0	GENERAL TOLERANCES (UNLESS SPECIFIED) <table border="1"> <tr> <th></th> <th>mm</th> <th>INCH</th> </tr> <tr> <td>4 PLACES</td> <td>± 0.1</td> <td>± 0.004</td> </tr> <tr> <td>3 PLACES</td> <td>± 0.15</td> <td>± 0.006</td> </tr> <tr> <td>2 PLACES</td> <td>± 0.2</td> <td>± 0.008</td> </tr> <tr> <td>1 PLACE</td> <td>± 0.3</td> <td>± 0.012</td> </tr> </table>		mm	INCH	4 PLACES	± 0.1	± 0.004	3 PLACES	± 0.15	± 0.006	2 PLACES	± 0.2	± 0.008	1 PLACE	± 0.3	± 0.012	DIMENSION STYLE MM ONLY	SCALE 1:1	DESIGN UNITS METRIC	THIRD ANGLE PROJECTION
		mm	INCH																		
	4 PLACES	± 0.1	± 0.004																		
	3 PLACES	± 0.15	± 0.006																		
2 PLACES	± 0.2	± 0.008																			
1 PLACE	± 0.3	± 0.012																			
DRAFT WHERE APPLICABLE MUST REMAIN WITHIN DIMENSIONS	SEE TABLE	MATERIAL NO. SD-36638-001	DOCUMENT NO. SD-36638-001	TITLE CMC HEADER T3 INTERFACE - BK & BR 96/72 AND 96/96	SHEET NO. 1 OF 3	MOLEX INCORPORATED															
THIS DRAWING CONTAINS INFORMATION THAT IS PROPRIETARY TO MOLEX INCORPORATED AND SHOULD NOT BE USED WITHOUT WRITTEN PERMISSION																					

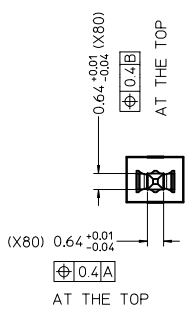

DETAIL 1
SCALE 10:1

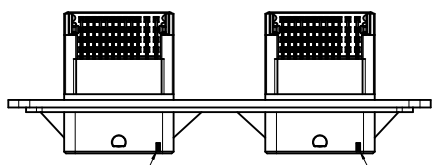
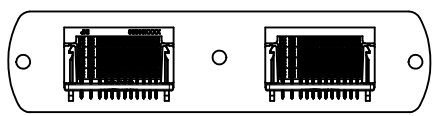
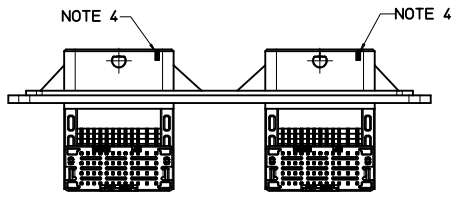
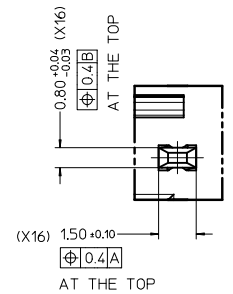

DETAIL 2
SCALE 10:1

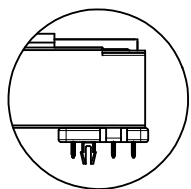

96/96 OR 96/72 MCMC HEADER
WITH PCB SNAP LOCKING

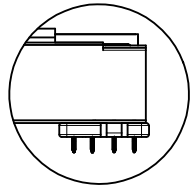

96/96 OR 96/72 MCMC HEADER
WITHOUT PCB SNAP LOCKING

36638-0012	CMC HEADER, T3-BR & BN, WITH PCB SNAP LOCK, 96/96	BROWN	BLACK	L1 & M1 L2 & M2 L3 & M3 L4 & M4	A1 TO H1, J1 & K1 A2 TO H2, J2 & K2 A3 TO H3, J3 & K3 A4 TO H4, J4 & K4	D
36638-0011	CMC HEADER, T3-BR & BN, W/O PCB SNAP LOCK, 96/96			C		
36638-0010	CMC HEADER, T3-BR & BN, WITH PCB SNAP LOCK, 96/72	BROWN	BLACK	L2 & M2 L3 & M3 L4 & M4	A2 TO H2, J2 & K2 A3 TO H3, J3 & K3 A4 TO H4, J4 & K4	B
36638-0001	CMC HEADER, T3-BR & BN, W/O PCB SNAP LOCK, 96/72			A		
MOLEX PART NO.	PART DISCRPTION	LEFT MODULE	RIGHT MODULE	1.5 PIN	0.64 PIN	PCB LAYOUT TO BE REFERRED
		COLOUR CODE		CAVITIES TO BE USED		

5	GRID PLATE WITH PCB LOCK	PBT 30% GLASS FILLED	BLACK	0	2	0	2	0
4	GRID PLATE W/O PCB LOCK		BLACK	2	0	2	0	2
3	HOUSING		BLACK	1	1	1	1	1
2	PIN 1.50	CuZn30	NICKEL UNDERCOAT: 1.3µM TO 2.2µM	12	12	16	16	12
1	PIN 0.64	CuZn30	MATTE TIN OVERCOAT: 4µM TO 5µM	60	60	80	80	60
SL.NO	DESIGNATION	MATERIAL	FINISH	BOM QUANTITY				
				36638-0001	36638-0010	36638-0011	36638-0012	36638-0010E

NOTE:

1. PAINT BROWN PAINT(RoHS COMPLIANT) AT THE SPECIFIED AREA OF LEFT MODULE ON BOTH SIDES
2. AREA FOR JXI AND MOLEX PART NUMBER REPRESENTATION.
3. AREA FOR PLASTIC MATERIAL >PBT-30%GF< DESCRIPTION.
4. PAINT WITH WHITE COLOR (RoHS COMPLIANT) AT SPECIFIED FOUR AREAS
5. PART TO MEET SOLDERABILITY SPEC SMES-152
6. PACKAGING SPECIFICATION: PK-36638-001
7. FOR PART # 36638-0001 REFER PACKAGING SPEC:PK-36638-004

RoHS COMPLIANT

ENTER DESCRIPTION IEC NO: 2012-0253 DRAWN: VITARRAR 2012/02/14 CHKD: APPR: KPRASAD 2012/02/15	QUALITY SYMBOLS ▽=0 ▽=0	GENERAL TOLERANCES (UNLESS SPECIFIED) mm INCH 4 PLACES ± --- ± --- 3 PLACES ± --- ± --- 2 PLACES ± 0.1 ± --- 1 PLACE ± 0.2 ± --- ANGULAR ± 1°	DIMENSION STYLE MM ONLY	SCALE 1:1	DESIGN UNITS METRIC	THIRD ANGLE PROJECTION	
	DRAWN BY DKUMAR 20/12/2005	CHECKED BY KPRASAD 20/12/2005	APPROVED BY GJLOWE 20/12/2005	MATERIAL NO. SEE TABLE	DOCUMENT NO. SD-36638-001	SHEET NO. 2 OF 3	CMC HEADER T3 INTERFACE - BK & BR 96/72 AND 96/96 MOLEX INCORPORATED
	DRAFT WHERE APPLICABLE MUST REMAIN WITHIN DIMENSIONS			THIS DRAWING CONTAINS INFORMATION THAT IS PROPRIETARY TO MOLEX INCORPORATED AND SHOULD NOT BE USED WITHOUT WRITTEN PERMISSION			
	SIZE 1						

PCB LAYOUT: A

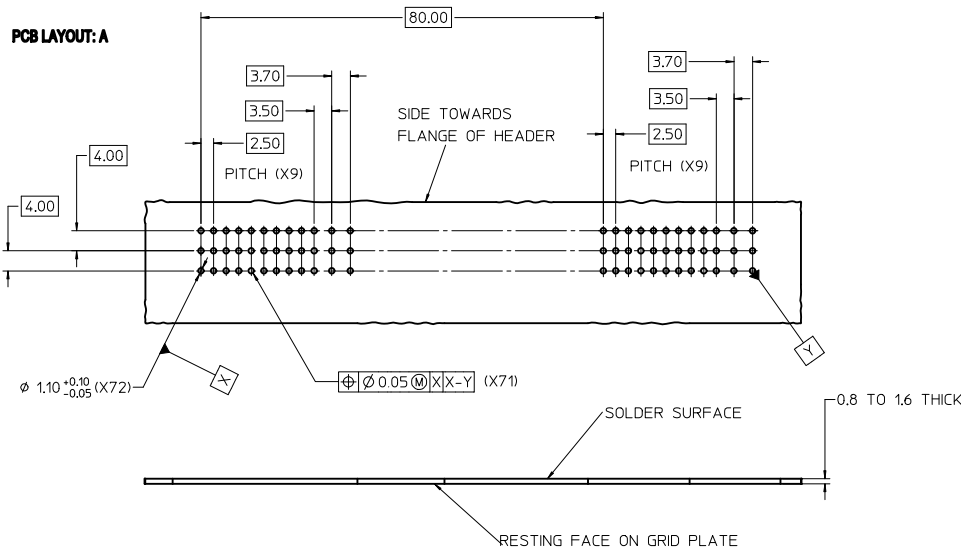

PCB LAYOUT: B

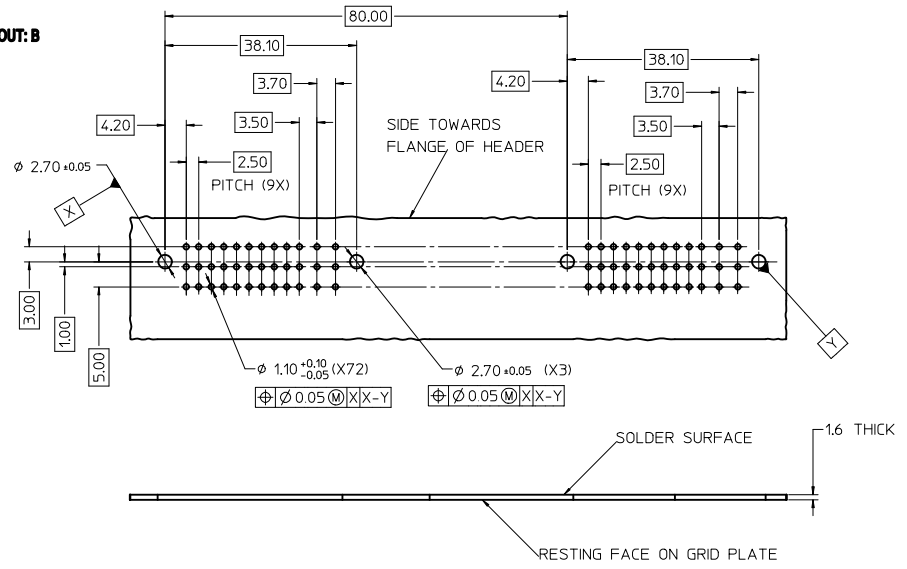

PCB LAYOUT: C

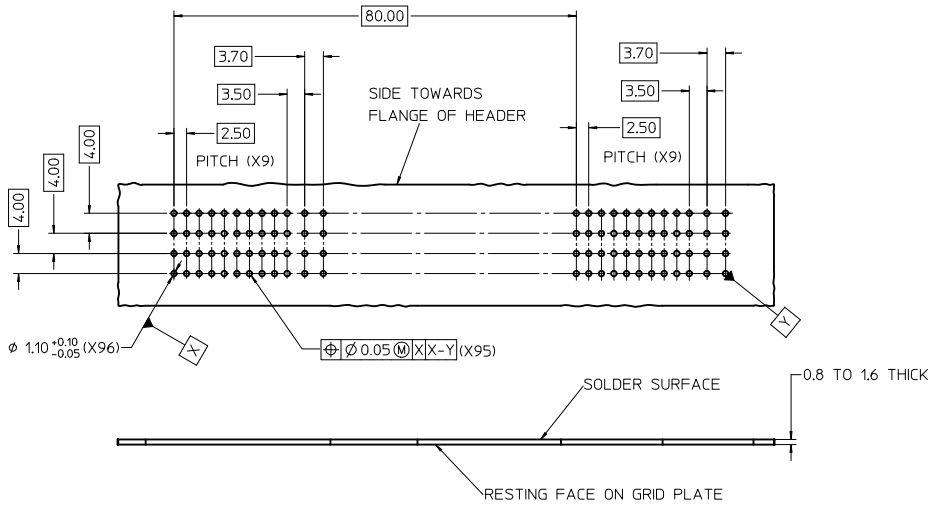

PCB LAYOUT: D

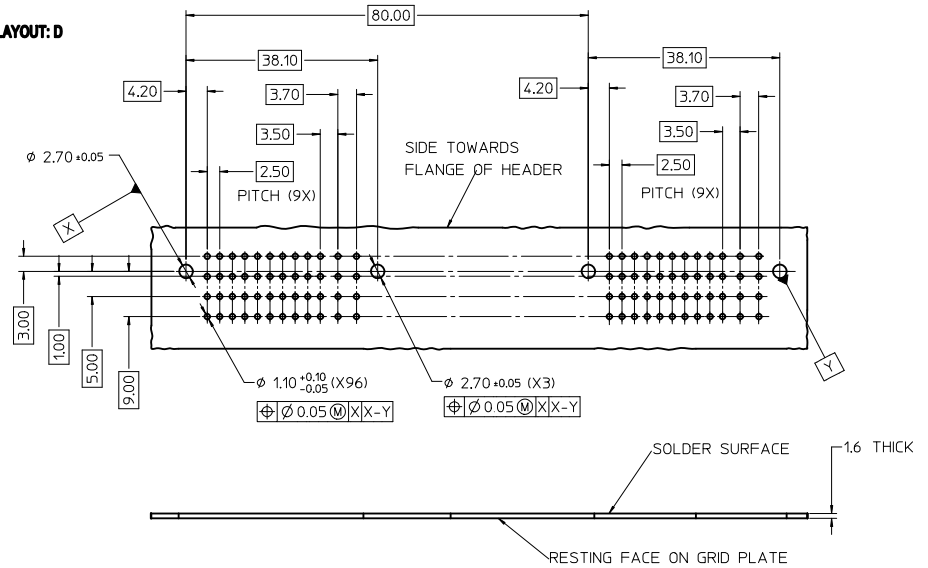

RoHS COMPLIANT

ENTER DESCRIPTION EC NO: 2012-0253 DRAWN BY: DRW:NVIT/ARKAR CHKD: APPR:KPRASAD 2012/02/15	QUALITY SYMBOLS $\nabla=0$ $\nabla=0$	GENERAL TOLERANCES (UNLESS SPECIFIED) mm INCH 4 PLACES ± --- ± --- 3 PLACES ± --- ± --- 2 PLACES ± 0.1 ± --- 1 PLACE ± 0.2 ± --- ANGULAR ± 1 °	DIMENSION STYLE MM ONLY	SCALE 2:1	DESIGN UNITS METRIC	THIRD ANGLE PROJECTION
	DRAFT WHERE APPLICABLE MUST REMAIN WITHIN DIMENSIONS	SEE TABLE	DIMENSION STYLE MM ONLY	SCALE 2:1	DESIGN UNITS METRIC	THIRD ANGLE PROJECTION
	MATERIAL NO.	SEE TABLE	DIMENSION STYLE MM ONLY	SCALE 2:1	DESIGN UNITS METRIC	THIRD ANGLE PROJECTION
	DOCUMENT NO.	SEE TABLE	DIMENSION STYLE MM ONLY	SCALE 2:1	DESIGN UNITS METRIC	THIRD ANGLE PROJECTION

CMC HEADER
T3 INTERFACE - BK & BR
96/72 AND 96/96

MOLEX INCORPORATED
SD-36638-001

SHEET NO.
3 OF 3

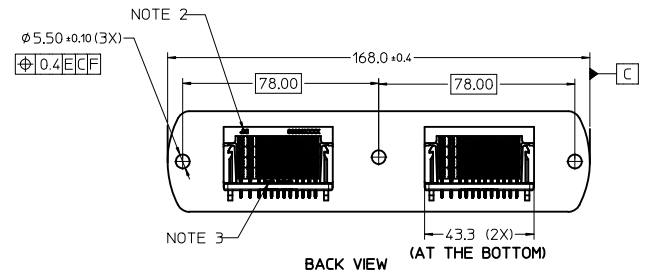
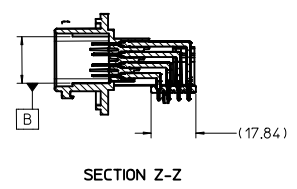
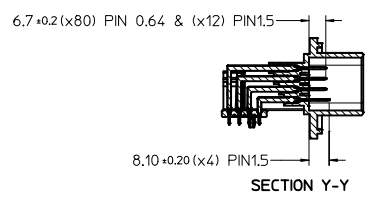
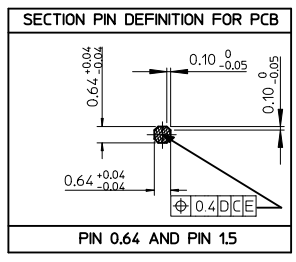
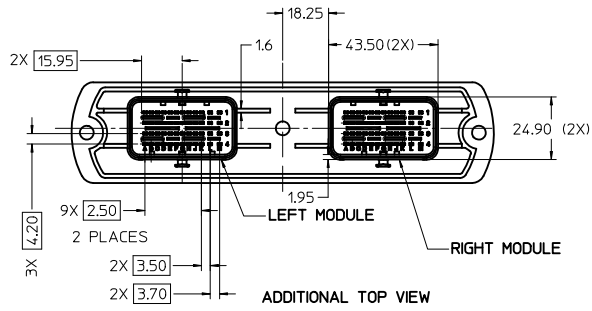
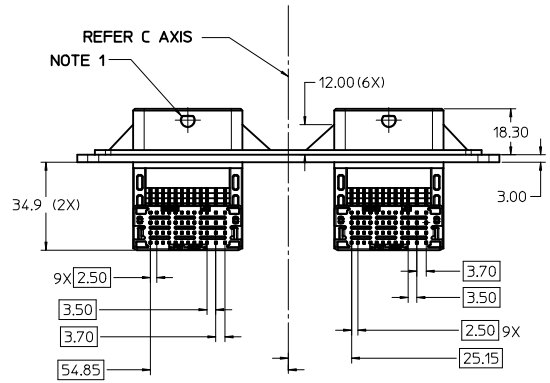
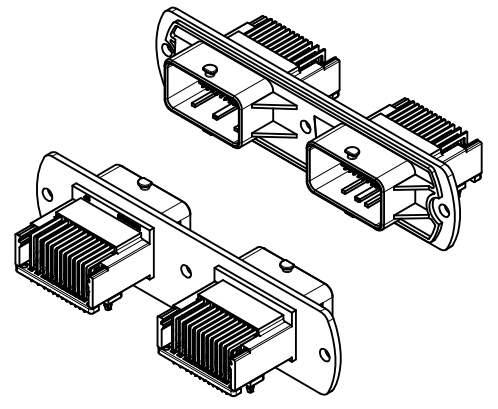
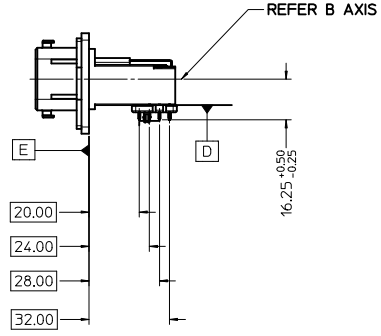
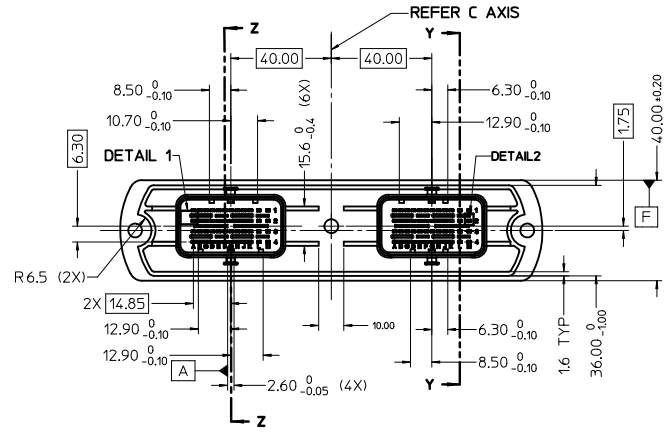

RoHS COMPLIANT

ENTER DESCRIPTION IEC NO: 2012-0253 DRAWN: VITTHAR 2012/02/14 CHKD: APPR: KPRASAD REV:	QUALITY SYMBOLS ▽=0 ▽=0	GENERAL TOLERANCES (UNLESS SPECIFIED) <table border="1"> <tr> <th></th> <th>mm</th> <th>INCH</th> </tr> <tr> <td>4 PLACES</td> <td>± 0.1</td> <td>± 0.004</td> </tr> <tr> <td>3 PLACES</td> <td>± 0.15</td> <td>± 0.006</td> </tr> <tr> <td>2 PLACES</td> <td>± 0.2</td> <td>± 0.008</td> </tr> <tr> <td>1 PLACE</td> <td>± 0.3</td> <td>± 0.012</td> </tr> </table>		mm	INCH	4 PLACES	± 0.1	± 0.004	3 PLACES	± 0.15	± 0.006	2 PLACES	± 0.2	± 0.008	1 PLACE	± 0.3	± 0.012	DIMENSION STYLE MM ONLY	SCALE 1:1	DESIGN UNITS METRIC	THIRD ANGLE PROJECTION
		mm	INCH																		
	4 PLACES	± 0.1	± 0.004																		
	3 PLACES	± 0.15	± 0.006																		
2 PLACES	± 0.2	± 0.008																			
1 PLACE	± 0.3	± 0.012																			
DRAFT WHERE APPLICABLE MUST REMAIN WITHIN DIMENSIONS	SEE TABLE	DRAWN BY DKUMAR DATE 20/12/2005	CHECKED BY KPRASAD DATE 20/12/2005	TITLE CMC HEADER T3 INTERFACE - BK & BR 96/72 AND 96/96	MATERIAL NO. SD-36638-001	DOCUMENT NO. SD-36638-001															
SIZE A1	THIS DRAWING CONTAINS INFORMATION THAT IS PROPRIETARY TO MOLEX INCORPORATED AND SHOULD NOT BE USED WITHOUT WRITTEN PERMISSION	APPROVED BY GJLOWE DATE 20/12/2005	MOLEX INCORPORATED	SHEET NO. 1 OF 3																	

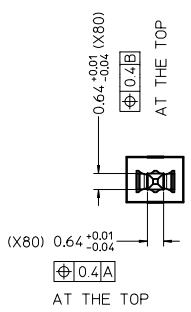
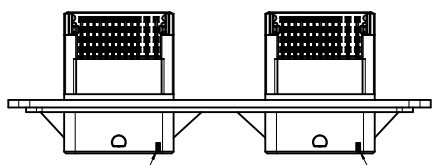
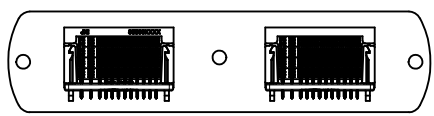
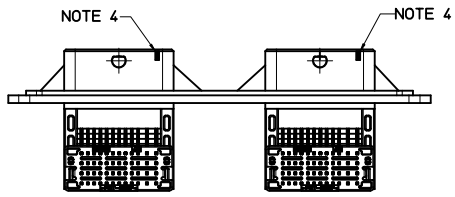

DETAIL 1
SCALE 10:1

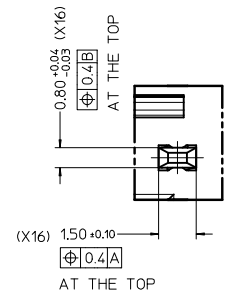

DETAIL 2
SCALE 10:1

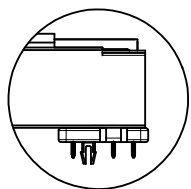

96/96 OR 96/72 CMC HEADER
WITH PCB SNAP LOCKING

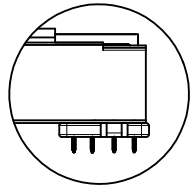

96/96 OR 96/72 CMC HEADER
WITHOUT PCB SNAP LOCKING

36638-0012	CMC HEADER, T3-BR & BN, WITH PCB SNAP LOCK, 96/96	BROWN	BLACK	L1 & M1 L2 & M2 L3 & M3 L4 & M4	A1 TO H1, J1 & K1 A2 TO H2, J2 & K2 A3 TO H3, J3 & K3 A4 TO H4, J4 & K4	D
36638-0011	CMC HEADER, T3-BR & BN, W/O PCB SNAP LOCK, 96/96			C		
36638-0010	CMC HEADER, T3-BR & BN, WITH PCB SNAP LOCK, 96/72	BROWN	BLACK	L2 & M2 L3 & M3 L4 & M4	A2 TO H2, J2 & K2 A3 TO H3, J3 & K3 A4 TO H4, J4 & K4	B
36638-0001	CMC HEADER, T3-BR & BN, W/O PCB SNAP LOCK, 96/72			A		
MOLEX PART NO.	PART DISCRPTION	LEFT MODULE	RIGHT MODULE	1.5 PIN	0.64 PIN	PCB LAYOUT TO BE REFERRED
		COLOUR CODE	CAVITIES TO BE USED			

5	GRID PLATE WITH PCB LOCK	PBT 30% GLASS FILLED	BLACK	0	2	0	2	0
4	GRID PLATE W/O PCB LOCK		BLACK	2	0	2	0	2
3	HOUSING		BLACK	1	1	1	1	1
2	PIN 1.50	CuZn30	NICKEL UNDERCOAT: 1.3µM TO 2.2µM	12	12	16	16	12
1	PIN 0.64	CuZn30	MATTE TIN OVERCOAT: 4µM TO 5µM	60	60	80	80	60
SL.NO	DESIGNATION	MATERIAL	FINISH	BOM QUANTITY				
				36638-0001	36638-0010	36638-0011	36638-0012	36638-0010E

- NOTE:
1. PAINT BROWN PAINT(RoHS COMPLIANT) AT THE SPECIFIED AREA OF LEFT MODULE ON BOTH SIDES
 2. AREA FOR JXI AND MOLEX PART NUMBER REPRESENTATION.
 3. AREA FOR PLASTIC MATERIAL >PBT-30%GF< DESCRIPTION.
 4. PAINT WITH WHITE COLOR (RoHS COMPLIANT) AT SPECIFIED FOUR AREAS
 5. PART TO MEET SOLDERABILITY SPEC SMES-152
 6. PACKAGING SPECIFICATION: PK-36638-001
 7. FOR PART # 36638-0001 REFER PACKAGING SPEC:PK-36638-004

RoHS COMPLIANT

ENTER DESCRIPTION IEC NO: 2012-0253 DRAWN:VITARRAR 2012/02/14 CHKD: APPR:KPRASAD REV:	QUALITY SYMBOLS	GENERAL TOLERANCES (UNLESS SPECIFIED)	DIMENSION STYLE	SCALE	DESIGN UNITS	THIRD ANGLE PROJECTION
	▽=0	mm INCH	MM ONLY	1:1	METRIC	
	▽=0	4 PLACES ± --- ± ---	DRAWN BY DATE	TITLE		
		3 PLACES ± --- ± ---	DKUMAR 20/12/2005	CMC HEADER T3 INTERFACE - BK & BR 96/72 AND 96/96		
	2 PLACES ± 0.1 ± ---	CHECKED BY DATE	MOLEX INCORPORATED			
	1 PLACE ± 0.2 ± ---	KPRASAD 20/12/2005	MATERIAL NO. SD-36638-001			
	ANGULAR ± 1 °	APPROVED BY DATE	DOCUMENT NO.			
		GJLOWE 20/12/2005	SHEET NO. 2 OF 3			
	DRAFT WHERE APPLICABLE MUST REMAIN WITHIN DIMENSIONS		THIS DRAWING CONTAINS INFORMATION THAT IS PROPRIETARY TO MOLEX INCORPORATED AND SHOULD NOT BE USED WITHOUT WRITTEN PERMISSION			

PCB LAYOUT: A

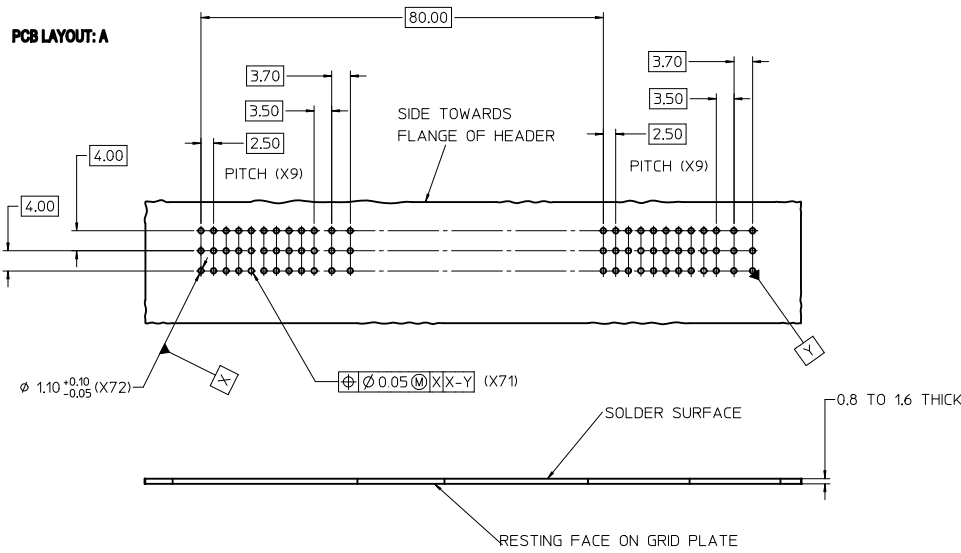

PCB LAYOUT: B

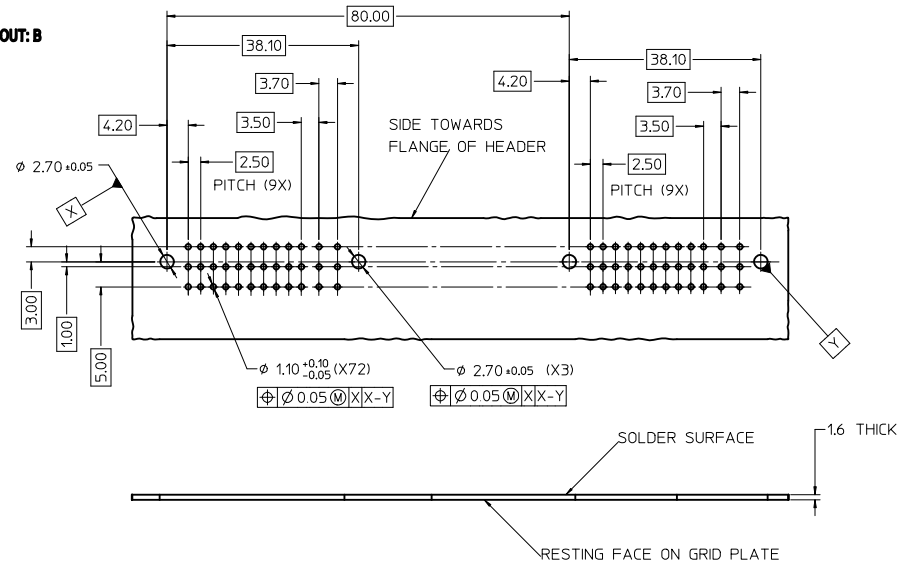

PCB LAYOUT: C

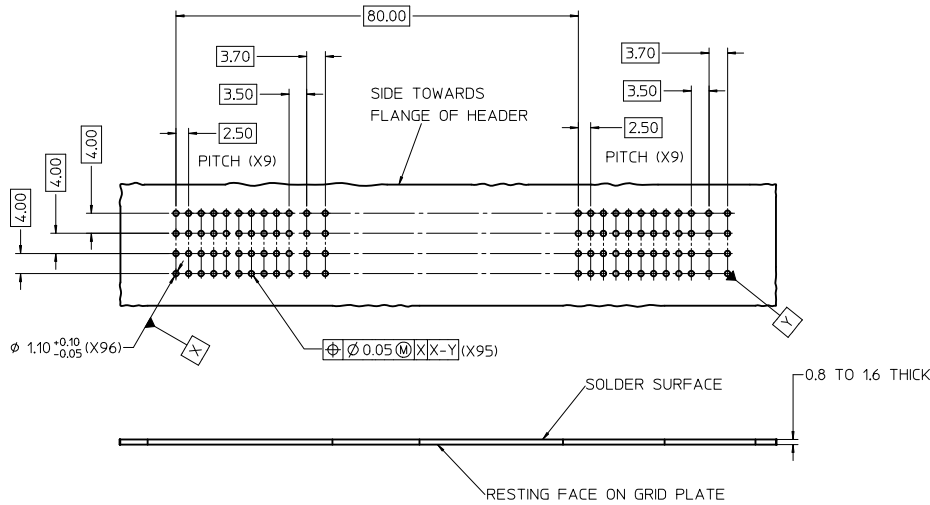

PCB LAYOUT: D

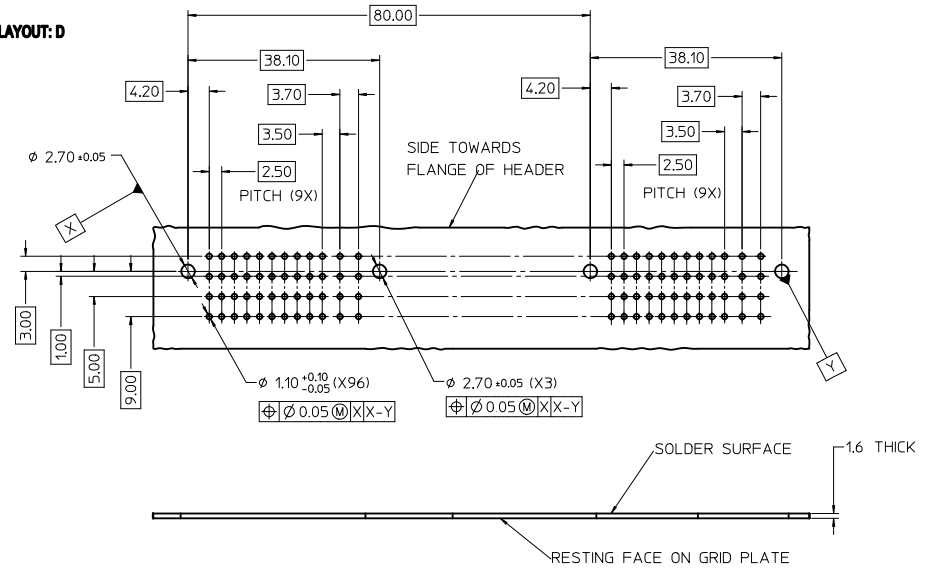

RoHS COMPLIANT

ENTER DESCRIPTION EC NO: 2012-0253 DRAWN BY: DRW:VITARRAR CHKD: APPR:KPRASAD 2012/02/15	QUALITY SYMBOLS ▽=0 ▽=0	GENERAL TOLERANCES (UNLESS SPECIFIED) mm INCH 4 PLACES ± --- ± --- 3 PLACES ± --- ± --- 2 PLACES ± 0.1 ± --- 1 PLACE ± 0.2 ± --- ANGULAR ± 1 °	DIMENSION STYLE MM ONLY	SCALE 2:1	DESIGN UNITS METRIC	THIRD ANGLE PROJECTION	
	DRAWN BY: DKUMAR DATE: 20/12/2005	CHECKED BY: KPRASAD DATE: 20/12/2005	APPROVED BY: GJLOWE DATE: 20/12/2005	MATERIAL NO. SEE TABLE	DOCUMENT NO. SD-36638-001	TITLE CMC HEADER T3 INTERFACE - BK & BR 96/72 AND 96/96	SHEET NO. 3 OF 3
	MOLEX INCORPORATED						
	THIS DRAWING CONTAINS INFORMATION THAT IS PROPRIETARY TO MOLEX INCORPORATED AND SHOULD NOT BE USED WITHOUT WRITTEN PERMISSION						