

3950X SERIES  
3.50mm HEADERS

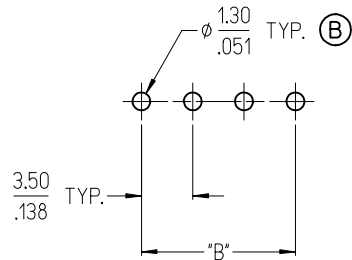

3952X & 3954X SERIES  
5.00mm HEADERS  
5.00mm FIXED

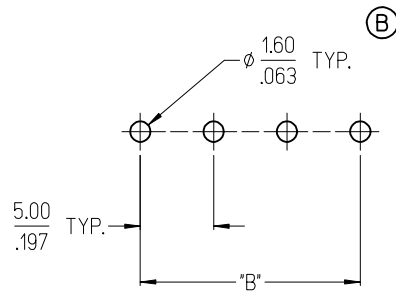

3953X SERIES  
5.08mm HEADERS

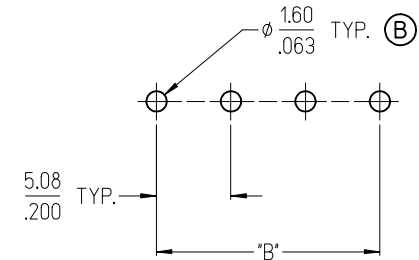

3951X SERIES  
3.81mm HEADERS

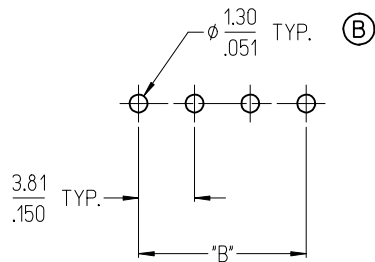

3954X SERIES  
5.00mm FIXED

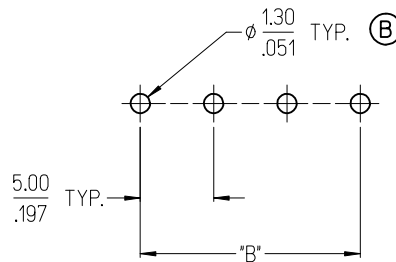

3954X SERIES  
5.08mm FIXED

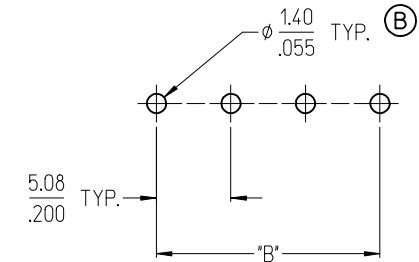

NOTES:

- REFER TO INDIVIDUAL PRODUCT SALES DRAWINGS FOR "B" DIMENSION.
- DOES NOT APPLY TO DUAL LEVEL HEADERS, SERIES 39528 AND 39538.
- TYP. = TYPICAL.

TOLERANCES			
MM	TOL	INCH	TOL
0-6	±0.25	0-.24	±.010
>6-30	±0.40	.24-1.18	±.016
>30-120	±0.50	1.18-4.76	±.020
>120	±0.80	>4.76	±.031

REVISED DOC TOL  
EC NO: IPG2017-0881  
DRAWN: VASUTHKARP 2017/03/23  
CHKD:  
APPR: BRUPERT 2017/04/18  
REV DESCRIPTION

QUALITY SYMBOLS  
▽=0  
▽=0

GENERAL TOLERANCES (UNLESS SPECIFIED)

	mm	INCH
4 PLACES	±---	±---
3 PLACES	±---	±---
2 PLACES	±---	±---
1 PLACE	±---	±---
ANGULAR ±---°		

DRAFT WHERE APPLICABLE  
MUST REMAIN  
WITHIN DIMENSIONS

DIMENSION STYLE  
MM/IN

DRAWN BY	DATE
C. YORK	2006/08/25
CHECKED BY	DATE
J. MACNEIL	2006/08/25
APPROVED BY	DATE
J. MACNEIL	2006/08/25

MATERIAL NO. --

SCALE DESIGN UNITS INCH

THIRD ANGLE PROJECTION

RECOMMENDED PCB LAYOUT FOR ESE TERMINAL BLOCKS

**molex** MOLEX INCORPORATED

DOCUMENT NO. SD-39501-002

SHEET NO. 1 OF 1

THIS DRAWING CONTAINS INFORMATION THAT IS PROPRIETARY TO MOLEX INCORPORATED AND SHOULD NOT BE USED WITHOUT WRITTEN PERMISSION

3950X SERIES  
3.50mm HEADERS

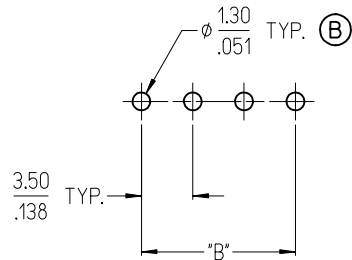

3952X & 3954X SERIES  
5.00mm HEADERS  
5.00mm FIXED

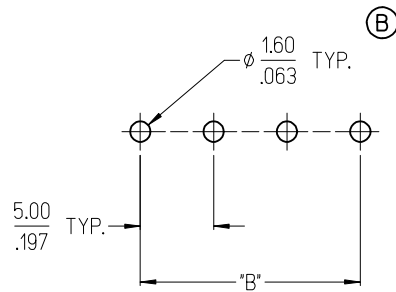

3953X SERIES  
5.08mm HEADERS

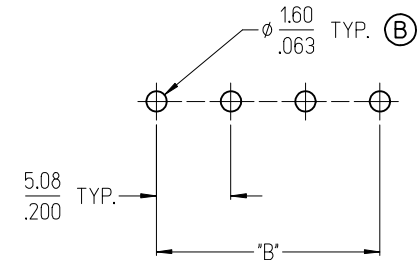

3951X SERIES  
3.81mm HEADERS

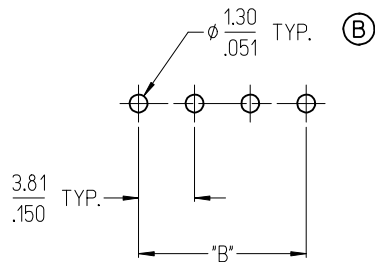

3954X SERIES  
5.00mm FIXED

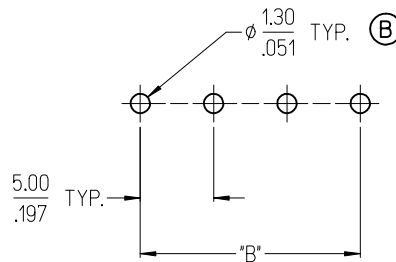

3954X SERIES  
5.08mm FIXED

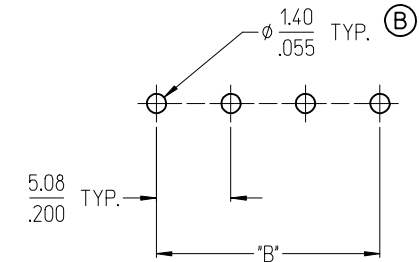

NOTES:

- REFER TO INDIVIDUAL PRODUCT SALES DRAWINGS FOR "B" DIMENSION.
- DOES NOT APPLY TO DUAL LEVEL HEADERS, SERIES 39528 AND 39538.
- TYP. = TYPICAL.

TOLERANCES			
MM	TOL	INCH	TOL
0-6	±0.25	0-.24	±.010
>6-30	±0.40	.24-1.18	±.016
>30-120	±0.50	1.18-4.76	±.020
>120	±0.80	>4.76	±.031

REVISED DOC TOL  
EC NO: IPG2017-0881  
DRAWN: VASUTHKARP 2017/03/23  
CHKD:  
APPR: BRUPERT 2017/04/18  
REV DESCRIPTION

QUALITY SYMBOLS  
▽=0  
▽=0

GENERAL TOLERANCES (UNLESS SPECIFIED)

	mm	INCH
4 PLACES	±---	±---
3 PLACES	±---	±---
2 PLACES	±---	±---
1 PLACE	±---	±---
ANGULAR ±---°		

DRAFT WHERE APPLICABLE  
MUST REMAIN  
WITHIN DIMENSIONS

DIMENSION STYLE  
MM/IN

DRAWN BY	DATE
C. YORK	2006/08/25
CHECKED BY	DATE
J. MACNEIL	2006/08/25
APPROVED BY	DATE
J. MACNEIL	2006/08/25

MATERIAL NO. --

SCALE DESIGN UNITS INCH

THIRD ANGLE PROJECTION

RECOMMENDED PCB LAYOUT FOR ESE TERMINAL BLOCKS

**molex** MOLEX INCORPORATED

DOCUMENT NO. SD-39501-002

SHEET NO. 1 OF 1

THIS DRAWING CONTAINS INFORMATION THAT IS PROPRIETARY TO MOLEX INCORPORATED AND SHOULD NOT BE USED WITHOUT WRITTEN PERMISSION

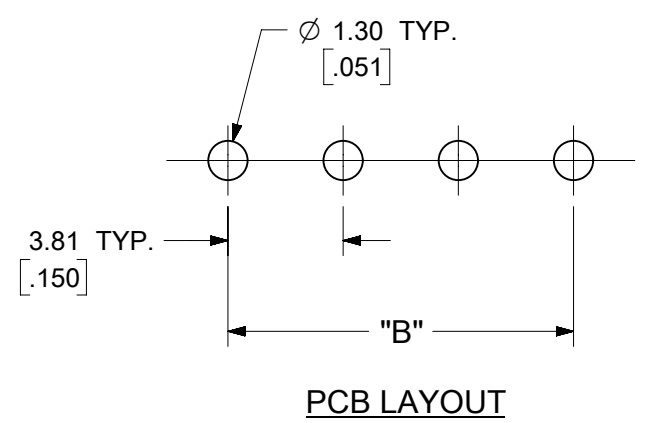
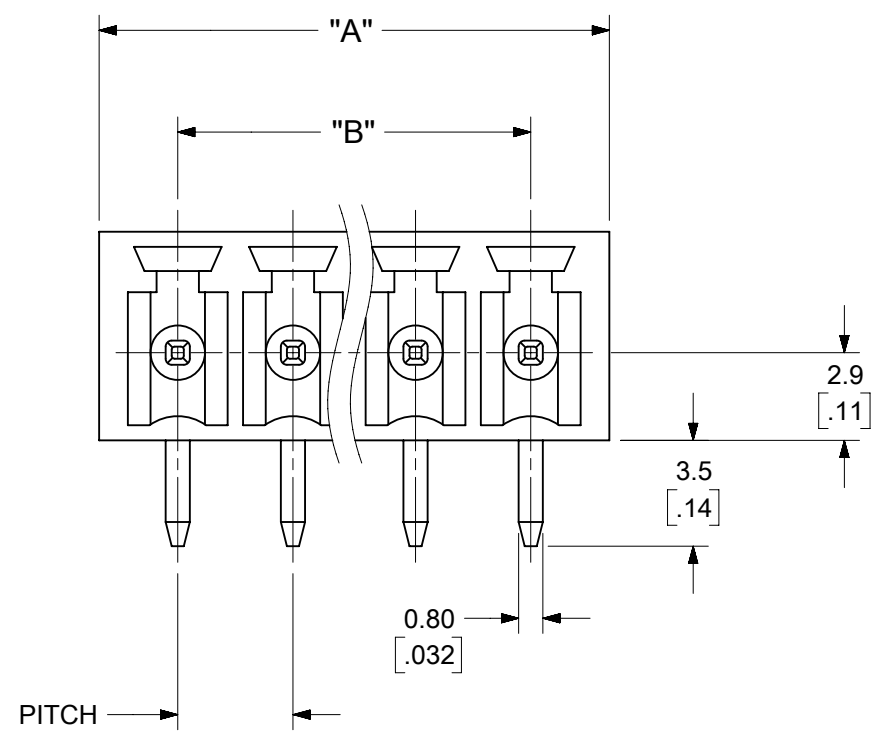
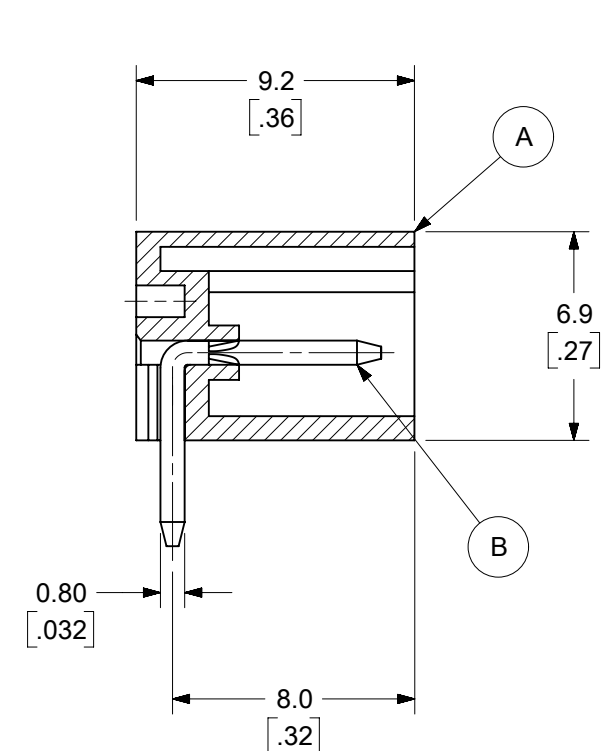
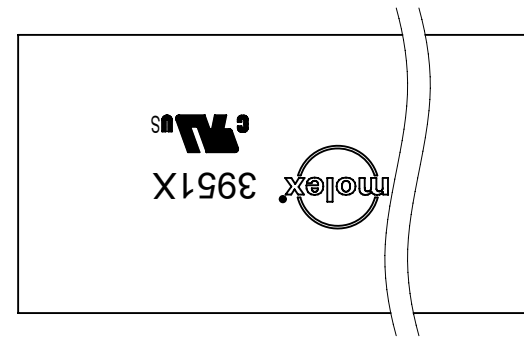
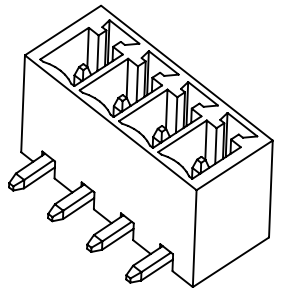

**SPECIFICATIONS:**

1. MATERIAL:
  - (A). BODY: PA66
  - (B). TERMINAL: BRASS
2. WIRE RANGE: N/A
3. ELECTRICAL RATING: 300V, 8A.
4. MAX TORQUE: N/A.
5. WIRE STRIP LENGTH: N/A.
6. OPERATING TEMPERATURE: -40°C to +105°C.
7.  $A = (N \times P) + 1.39\text{MM}$
8.  $B = (N - 1) \times P$
9.  $P \text{ (PITCH)} = 3.81\text{MM} (.150\text{'})$ .
10. N = NUMBER OF POSITIONS AVAILABLE 2 THROUGH 20.

TOLERANCES			
MM	TOL	INCH	TOL
0-6	±0.25	0-.24	±.010
>6-30	±0.40	.24-1.18	±.016
>30-120	±0.50	1.18-4.76	±.020
>120	±0.80	>4.76	±.031

<b>SYMBOLS</b> ▽ = 0 ▽ = 0 ▽ = 0 ▽ = 0 ▽ = 0 ▽ = 0 ▽ = 0 ▽ = 0 ▽ = 0 ▽ = 0 ▽ = 0 ▽ = 0	THIS DRAWING CONTAINS INFORMATION THAT IS PROPRIETARY TO MOLEX ELECTRONIC TECHNOLOGIES, LLC AND SHOULD NOT BE USED WITHOUT WRITTEN PERMISSION	DIMENSION UNITS: <b>MM/INCH</b> SCALE: <b>4:1</b>	CURRENT REV DESC: MIGRATION TO ECTR/NX EC NO: 619930 DRWN: ABENJAMINLW 2019/06/17 CHK'D: DACHAMMER 2019/07/01 APPR: JFMURPHY 2019/07/08			
	GENERAL TOLERANCES (UNLESS SPECIFIED) 4 PLACES ± 3 PLACES ± 2 PLACES ± 1 PLACE ± 0 PLACES ± ANGULAR TOL ± °	SEE CHART SEE CHART SEE CHART SEE CHART	INITIAL REVISION: DRWN: LROTHAUS 2006/01/09 APPR: JPAWLICK 2006/01/10	3.81MM, EURO HEADER RIGHT ANGLE, CLOSED END		
DRAFT WHERE APPLICABLE MUST REMAIN WITHIN DIMENSIONS	THIRD ANGLE PROJECTION	DRAWING: <b>B-SIZE</b> SERIES: <b>39512</b>	MATERIAL NUMBER: SEE SHEET-2 CUSTOMER: GENERAL MARKET	DOCUMENT NUMBER: <b>SD-39512-001</b> DOC TYPE: PSD DOC PART: 001 REVISION: <b>B2</b>	SHEET NUMBER: 1 OF 2	

F	CIRCUIT SIZE		MATERIAL NUMBERS												DIMENSIONAL INFORMATION			
			BLACK						GREEN									
			100% TIN			30 u" GOLD			100% TIN			30 u" GOLD						
			PRINTING OPTIONS			PRINTING OPTIONS			PRINTING OPTIONS			PRINTING OPTIONS						
DESCRIPTION		None	10AV	11AV	None	10AV	11AV	None	10AV	11AV	None	10AV	11AV	mm	inch	mm	inch	
3.81MM, EURO HEADER, RIGHT ANGLE	2	395121002	395121102	395121202	395121502	395121602	395121702	395126002	395126102	395126202	395126502	395126602	395126702	9.01	.355	3.81	.150	
3.81MM, EURO HEADER, RIGHT ANGLE	3	395121003	395121103	395121203	395121503	395121603	395121703	395126003	395126103	395126203	395126503	395126603	395126703	12.82	.505	7.62	.300	
3.81MM, EURO HEADER, RIGHT ANGLE	4	395121004	395121104	395121204	395121504	395121604	395121704	395126004	395126104	395126204	395126504	395126604	395126704	16.63	.655	11.43	.450	
3.81MM, EURO HEADER, RIGHT ANGLE	5	395121005	395121105	395121205	395121505	395121605	395121705	395126005	395126105	395126205	395126505	395126605	395126705	20.44	.805	15.24	.600	
3.81MM, EURO HEADER, RIGHT ANGLE	6	395121006	395121106	395121206	395121506	395121606	395121706	395126006	395126106	395126206	395126506	395126606	395126706	24.25	.955	19.05	.750	
3.81MM, EURO HEADER, RIGHT ANGLE	7	395121007	395121107	395121207	395121507	395121607	395121707	395126007	395126107	395126207	395126507	395126607	395126707	28.06	1.105	22.86	.900	
3.81MM, EURO HEADER, RIGHT ANGLE	8	395121008	395121108	395121208	395121508	395121608	395121708	395126008	395126108	395126208	395126508	395126608	395126708	31.87	1.255	26.67	1.050	
3.81MM, EURO HEADER, RIGHT ANGLE	9	395121009	395121109	395121209	395121509	395121609	395121709	395126009	395126109	395126209	395126509	395126609	395126709	35.68	1.405	30.48	1.200	
3.81MM, EURO HEADER, RIGHT ANGLE	10	395121010	395121110	395121210	395121510	395121610	395121710	395126010	395126110	395126210	395126510	395126610	395126710	39.49	1.555	34.29	1.350	
3.81MM, EURO HEADER, RIGHT ANGLE	11	395121011	395121111	395121211	395121511	395121611	395121711	395126011	395126111	395126211	395126511	395126611	395126711	43.30	1.705	38.10	1.500	
3.81MM, EURO HEADER, RIGHT ANGLE	12	395121012	395121112	395121212	395121512	395121612	395121712	395126012	395126112	395126212	395126512	395126612	395126712	47.11	1.855	41.91	1.650	
3.81MM, EURO HEADER, RIGHT ANGLE	13	395121013	395121113	395121213	395121513	395121613	395121713	395126013	395126113	395126213	395126513	395126613	395126713	50.92	2.005	45.72	1.800	
3.81MM, EURO HEADER, RIGHT ANGLE	14	395121014	395121114	395121214	395121514	395121614	395121714	395126014	395126114	395126214	395126514	395126614	395126714	54.73	2.155	49.53	1.950	
3.81MM, EURO HEADER, RIGHT ANGLE	15	395121015	395121115	395121215	395121515	395121615	395121715	395126015	395126115	395126215	395126515	395126615	395126715	58.54	2.305	53.34	2.100	
3.81MM, EURO HEADER, RIGHT ANGLE	16	395121016	395121116	395121216	395121516	395121616	395121716	395126016	395126116	395126216	395126516	395126616	395126716	62.35	2.455	57.15	2.250	
3.81MM, EURO HEADER, RIGHT ANGLE	17	395121017	395121117	395121217	395121517	395121617	395121717	395126017	395126117	395126217	395126517	395126617	395126717	66.16	2.605	60.96	2.400	
3.81MM, EURO HEADER, RIGHT ANGLE	18	395121018	395121118	395121218	395121518	395121618	395121718	395126018	395126118	395126218	395126518	395126618	395126718	69.97	2.755	64.77	2.550	
3.81MM, EURO HEADER, RIGHT ANGLE	19	395121019	395121119	395121219	395121519	395121619	395121719	395126019	395126119	395126219	395126519	395126619	395126719	73.78	2.905	68.58	2.700	
3.81MM, EURO HEADER, RIGHT ANGLE	20	395121020	395121120	395121220	395121520	395121620	395121720	395126020	395126120	395126220	395126520	395126620	395126720	77.59	3.055	72.39	2.850	

<b>TOLERANCES</b>				<b>SYMBOLS</b> 	THIS DRAWING CONTAINS INFORMATION THAT IS PROPRIETARY TO MOLEX ELECTRONIC TECHNOLOGIES, LLC AND SHOULD NOT BE USED WITHOUT WRITTEN PERMISSION				<b>molex</b> 3.81MM, EURO HEADER RIGHT ANGLE, CLOSED END			
MM	TOL	INCH	TOL		DIMENSION UNITS: <b>MM/INCH</b> SCALE: <b>2:1</b> CURRENT REV DESC: MIGRATION TO ECTR/NX				EC NO: 619930 DRWN: ABENJAMINLW    2019/06/17 CHK'D: DACHAMMER    2019/07/01 APPR: JFMURPHY    2019/07/08			
0-6	±0.25	0-.24	±.010		GENERAL TOLERANCES (UNLESS SPECIFIED)				PRODUCT CUSTOMER DRAWING			
>6-30	±0.40	.24-1.18	±.016		4 PLACES ±    3 PLACES ±    2 PLACES ±    1 PLACE ±    0 PLACES ±				INITIAL REVISION: DRWN: LROTHAUS    2006/01/09 APPR: JPAWLICK    2006/01/10			
>30-120	±0.50	1.18-4.76	±.020		ANGULAR TOL ± °				DOCUMENT NUMBER: <b>SD-39512-001</b> DOC TYPE: PSD    DOC PART: 001    REVISION: B2			
>120	±0.80	>4.76	±.031	DRAFT WHERE APPLICABLE MUST REMAIN WITHIN DIMENSIONS				THIRD ANGLE PROJECTION    DRAWING: B-SIZE    SERIES: 39512    MATERIAL NUMBER: SEE TABLE    CUSTOMER: GENERAL MARKET    SHEET NUMBER: 2 OF 2				