

PLEASE CHECK WWW.MOLEX.COM FOR LATEST PART INFORMATION

Part Number: [0395220012](#)
Status: **Active**
Overview: Eurostyle Terminal Blocks
Description: 5.00mm Pitch Eurostyle Horizontal PCB Header, Open Ends, 12 Circuits

Documents:

3D Model	Product Specification PS-39500-001-001 (PDF)
Drawing (PDF)	RoHS Certificate of Compliance (PDF)
3D Model (PDF)	

Agency Certification

UL E48521

General

Product Family	Terminal Blocks
Series	39522
Application	N/A
Component Type	PCB Header
Overview	Eurostyle Terminal Blocks
Product Name	ESE, Eurostyle Pluggable
Type	Euro Block
UPC	822350434959

Physical

Circuits (Loaded)	12
Entry Angle	N/A
Lock to Mating Part	Yes
Number of Rows	1
Orientation	Horizontal
PC Tail Length	3.90mm
PCB Thickness - Recommended	3.20mm
Panel Mount	No
Pitch - Mating Interface	5.00mm
Pitch - Termination Interface	5.00mm
Polarized to Mating Part	Yes
Shrouded	Open Ends
Stackable	No
Surface Mount Compatible (SMC)	N/A
Temperature Range - Operating	-40° to +105°C
Wire Size AWG	N/A

Electrical

Current - Maximum per Contact	15.0A
Voltage - Maximum	300V

Solder Process Data

Lead-freeProcess Capability N/A

Material Info

Reference - Drawing Numbers

Product Specification	PS-39500-001-001
Sales Drawing	SD-39522-003, SD-39522-003-001

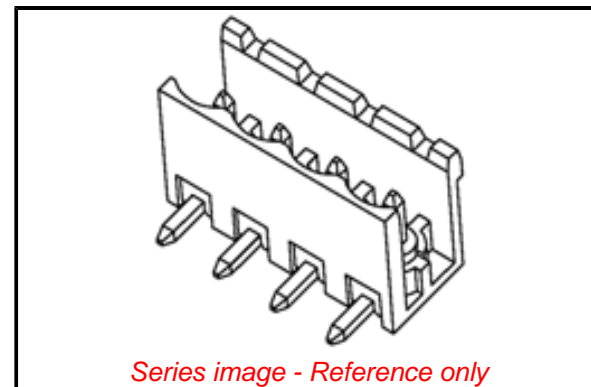

EU ELV

Not Relevant

EU RoHS

Not Reviewed

REACH SVHC

Not Reviewed

Halogen-Free

Status

Not Reviewed

For more information, please visit [Contact US](#)

China ROHS Not Reviewed

ELV Not Relevant

RoHS Phthalates Not Reviewed

Search Parts in this Series

[39522](#) Series

Mates With

[39520](#) Horizontal Plug, [39523](#) Vertical Plug,
Most 5.00mm Pitch Industry Standard Plugs