

**PLEASE CHECK WWW.MOLEX.COM FOR LATEST PART INFORMATION**

**Part Number:** **0395221018**  
**Status:** **Active**  
**Overview:** Eurostyle Terminal Blocks  
**Description:** 5.00mm Pitch Eurostyle Horizontal PCB Header, 18 Circuits

**Documents:**

[3D Model](#) [Product Specification PS-39500-001-001 \(PDF\)](#)  
[3D Model \(PDF\)](#) [RoHS Certificate of Compliance \(PDF\)](#)  
[Drawing \(PDF\)](#)

**Agency Certification**

UL E48521

**General**

Product Family Terminal Blocks  
Series [39522](#)  
Application N/A  
Component Type PCB Header  
Overview [Eurostyle Terminal Blocks](#)  
Product Name ESE, Eurostyle Pluggable  
Type Euro Block  
UPC 822350439923

**Physical**

Circuits (Loaded) 18  
Entry Angle N/A  
Lock to Mating Part Yes  
Number of Rows 1  
Orientation Horizontal  
PC Tail Length 3.90mm  
PCB Thickness - Recommended 3.20mm  
Panel Mount No  
Pitch - Mating Interface 5.00mm  
Pitch - Termination Interface 5.00mm  
Polarized to Mating Part Yes  
Shrouded Closed Ends  
Stackable No  
Temperature Range - Operating -40° to +105°C  
Wire Size AWG N/A

**Electrical**

Current - Maximum per Contact 15.0A  
Voltage - Maximum 300V

**Solder Process Data**

Lead-freeProcess Capability N/A

**Material Info**

**Reference - Drawing Numbers**

Product Specification PS-39500-001-001  
Sales Drawing SD-39522-002-001

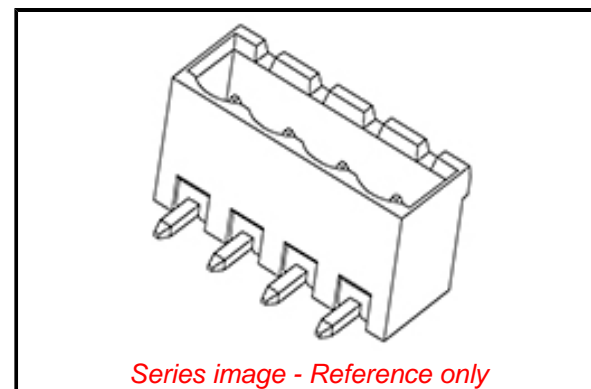

Series image - Reference only

**EU ELV**

**Not Relevant**

**EU RoHS**

**Not Reviewed**

**REACH SVHC**

Not Reviewed

**Halogen-Free**

**Status**

**Not Reviewed**

For more information, please visit [Contact US](#)

China ROHS

Not Reviewed

ELV

Not Relevant

RoHS Phthalates

Not Reviewed

**China RoHS**

**Search Parts in this Series**

[39522](#) Series

**Mates With**

[39520](#) Horizontal Plug, [39523](#) Vertical Plug,  
Most 5.00mm Pitch Industry Standard Plugs