

PLEASE CHECK WWW.MOLEX.COM FOR LATEST PART INFORMATION

Part Number: [0395225009](#)
Status: **Active**
Overview: Eurostyle Terminal Blocks
Description: 5.00mm Pitch Eurostyle Horizontal PCB Header, Open Ends, Green Housing, 9 Circuits

Documents:

[3D Model](#) [Product Specification PS-39500-001-001 \(PDF\)](#)
[3D Model \(PDF\)](#) [RoHS Certificate of Compliance \(PDF\)](#)
[Drawing \(PDF\)](#)

Agency Certification

UL E48521

General

Product Family Terminal Blocks
 Series [39522](#)
 Application N/A
 Component Type PCB Header
 Overview [Eurostyle Terminal Blocks](#)
 Product Name ESE, Eurostyle Pluggable
 Type Euro Block
 UPC 822350449533

Physical

Circuits (Loaded) 9
 Entry Angle N/A
 Lock to Mating Part Yes
 Number of Rows 1
 Orientation Horizontal
 PC Tail Length 3.90mm
 PCB Thickness - Recommended 3.20mm
 Panel Mount No
 Pitch - Mating Interface 5.00mm
 Pitch - Termination Interface 5.00mm
 Polarized to Mating Part Yes
 Shrouded Open Ends
 Stackable No
 Surface Mount Compatible (SMC) N/A
 Temperature Range - Operating -40° to +105°C
 Wire Size AWG N/A

Electrical

Current - Maximum per Contact 15.0A
 Voltage - Maximum 300V

Solder Process Data

Lead-freeProcess Capability N/A

Material Info

Reference - Drawing Numbers

Product Specification PS-39500-001-001
 Sales Drawing SD-39522-003, SD-39522-003-001

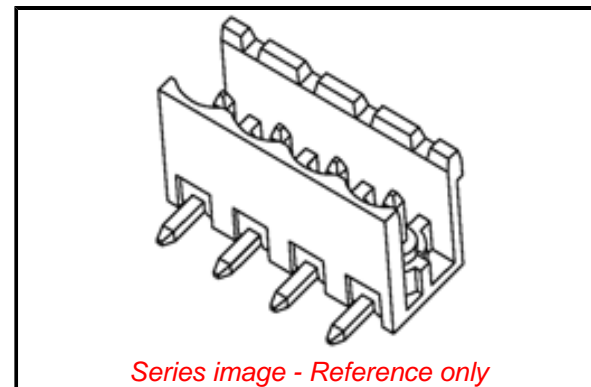

EU ELV

Not Relevant

EU RoHS

Not Reviewed

REACH SVHC

Not Reviewed

Halogen-Free

Status

Not Reviewed

For more information, please visit [Contact US](#)

China ROHS

Not Reviewed

ELV

Not Relevant

RoHS Phthalates

Not Reviewed

China RoHS

Search Parts in this Series

[39522](#) Series

Mates With

[39520](#) Horizontal Plug, [39523](#) Vertical Plug,
 Most 5.00mm Pitch Industry Standard Plugs

PLEASE CHECK WWW.MOLEX.COM FOR LATEST PART INFORMATION