

Distributed by:

JAMECO[®]
ELECTRONICS

www.Jameco.com ♦ 1-800-831-4242

The content and copyrights of the attached
material are the property of its owner.

Jameco Part Number 799844

FEATURES AND SPECIFICATIONS

Features and Benefits

- High current
- Fully polarized
- Positive locks
- Low engagement force
- Wire-to-board
- Metal board retention clip
- Surface Mount Compatible

Reference Information

Product Specification: PS-42815-0001
 Packaging: Tray
 UL File No.: E29179
 CSA File No.: LR19980
 TUV License No.: R9751144
 Mates With: [42816](#) receptacle housing
 Designed In: Millimeters

Electrical

Voltage: 600V
 Current: 48.0A max.*
 Contact Resistance: 1.5mΩ max.
 Dielectric Withstanding Voltage: 2200V
 Insulation Resistance: 1000 MΩ min.

Mechanical

Insertion Force to PCB: 19.6N max.
 Normal Force: 1.96N min.
 Durability: 30 cycles

Physical

Housing: Glass-filled, 4/6 nylon, UL 94V-0
 Contact: Copper Alloy
 Plating: Tin/Lead over Nickel
 Operating Temperature: -40 to +105°C
 PCB Thickness: 1.57, 2.36, 3.18, or 6.35mm
 (.062, .093, .125, or .250")

* Depending on circuit size, wire gauge and PCB. Please refer to product specification.

molex® 10.00mm (.393") Pitch Mini-Fit, Sr.™ Header

42820

Right Angle, Single Row Metal Clip Mount

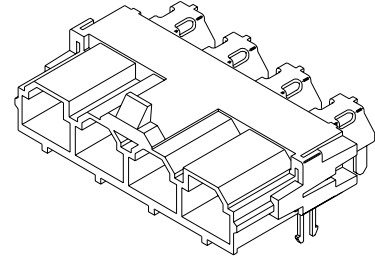

CATALOG DRAWING (FOR REFERENCE ONLY)

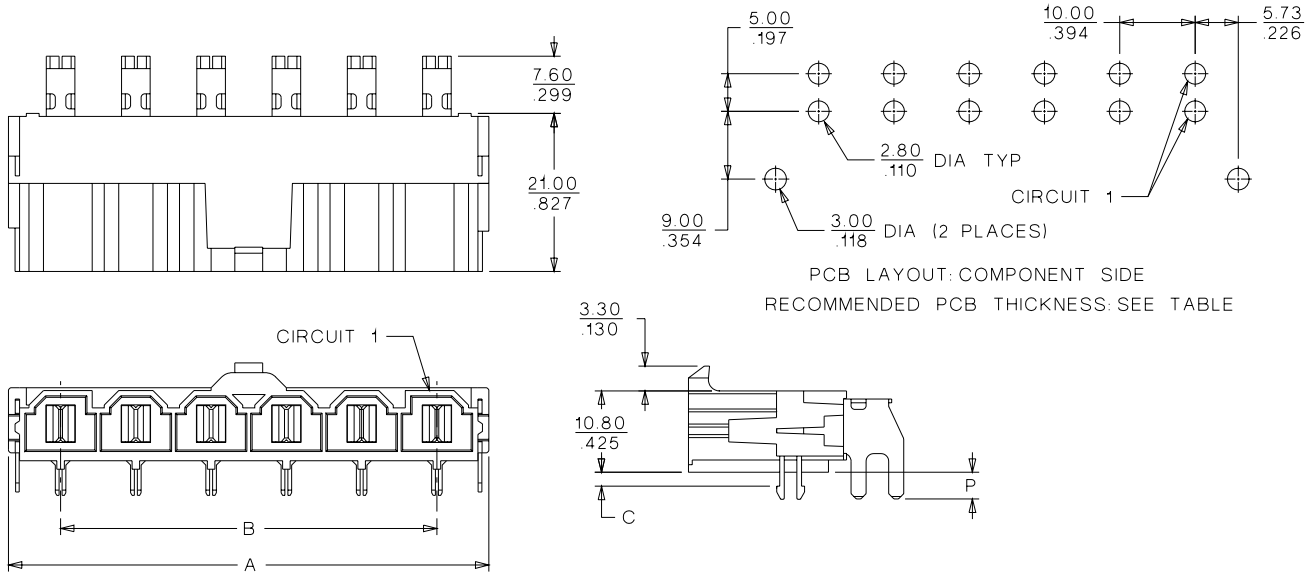

ORDERING INFORMATION AND DIMENSIONS

Circuits	Order No.	PCB Thickness	Dimension			
			A	B	C	P
2	42820-2212	1.57 (.062)	23.82 (.937)	10.00 (.393)	1.80 (.070)	3.50 (.137)
	42820-2222	2.36 (.093)			2.60 (.102)	5.10 (.200)
	42820-2232	3.18 (.125)			3.40 (.133)	5.10 (.200)
	42820-2242	6.35 (.250)			3.40 (.133)	8.30 (.327)
3	42820-3212	1.57 (.062)	33.82 (1.331)	20.00 (.787)	1.80 (.070)	3.50 (.137)
	42820-3222	2.36 (.093)			2.60 (.102)	5.10 (.200)
	42820-3232	3.18 (.125)			3.40 (.133)	5.10 (.200)
	42820-3242	6.35 (.250)			3.40 (.133)	8.30 (.327)
4	42820-4212	1.57 (.062)	43.82 (1.725)	30.00 (1.181)	1.80 (.070)	3.50 (.137)
	42820-4222	2.36 (.093)			2.60 (.102)	5.10 (.200)
	42820-4232	3.18 (.125)			3.40 (.133)	5.10 (.200)
	42820-4242	6.35 (.250)			3.40 (.133)	8.30 (.327)
5	42820-5212	1.57 (.062)	53.82 (2.118)	40.00 (1.574)	1.80 (.070)	3.50 (.137)
	42820-5222	2.36 (.093)			2.60 (.102)	5.10 (.200)
	42820-5232	3.18 (.125)			3.40 (.133)	5.10 (.200)
	42820-5242	6.35 (.250)			3.40 (.133)	8.30 (.327)
	42820-6212	1.57 (.062)			1.80 (.070)	3.50 (.137)
6	42820-6222	2.36 (.093)	63.82 (2.512)	50.00 (1.968)	1.80 (.070)	3.50 (.137)
	42820-6232	3.18 (.125)			2.60 (.102)	5.10 (.200)
	42820-6242	6.35 (.250)			3.40 (.133)	5.10 (.200)
					3.40 (.133)	8.30 (.327)



PRODUCT SPECIFICATION

MINI-FIT SR. SERIES

1.0 SCOPE

This specification covers the 10.00 mm / (.394 in.) centerline tin and gold plated connector series, single and dual row versions in wire to wire and wire to printed circuit board applications. This product performance is optimized for stranded tinned wire termination.

2.0 PRODUCT DESCRIPTION

2.1 PRODUCT NAME AND PART NUMBER

<u>Product Name</u>	<u>Part Number</u>
Female Terminal	42815-****
Male Terminal	42817-****
Receptacle (single row)	42816-****
Plug (single row)	42818-****
Vertical Header (single row)	42819-****
Right Angle Header (single row)	42820-****
Receptacle (dual row)	43914-****
TPA (dual row)	43980-****
Vertical Header (dual row)	43915-****
Panel Mount Plug (dual row)	43938-****

2.2 DIMENSIONS, MATERIALS PLATINGS & MARKINGS.

See the appropriate sales drawings for the information on dimensions, materials, platings and markings.

3.0 APPLICABLE DOCUMENTS AND SPECIFICATIONS

See sales drawings and the other sections of this specification for the necessary referenced documents and specifications.

3.1 Agency Approvals

UL File #E29179
CSA Certificate #LR 19980-555
TUV Certificate #R 9751144, #R 9950481

4.0 RATINGS

4.1 VOLTAGE RATINGS

IEC 950	250 Volts AC (RMS) / DC
UL / CSA	600 Volts AC (RMS) / DC
TUV	250 Volts AC

<u>REVISION:</u> 15	<u>ECR/ECN INFORMATION:</u> EC No: UCP2004-0403 DATE: 2003 / 08 / 29	<u>TITLE:</u> PRODUCT SPECIFICATION FOR MINI-FIT SR. CONNECTOR SYSTEM	<u>SHEET No.</u> 1 of 8
<u>DOCUMENT NUMBER:</u> PS-42815-001	<u>CREATED / REVISED BY:</u> M. CARRANZA	<u>CHECKED BY:</u> J. COMERCI	<u>APPROVED BY:</u> J. COMERCI



PRODUCT SPECIFICATION

4.2 CURRENT RATINGS

Rating is established based on MIL-W-5088 max. current capacity guidelines for copper conductors and test data summary TS-42815-001 section 5.3.7. Test data is based on 30 deg. C temperature rise using tin-plated terminals and UL 1015 tin stranded wire.

Single Row Product (tested to 30degC max. rise)

	2ckt. W to W	2ckt. W to PCB**	6ckt W to W	6ckt. W to PCB**
16 AWG	13A	13A	13A	13A
14 AWG	17A	17A	17A	17A
12 AWG	23A	23A	23A	23A
10 AWG	33A	33A	33A	33A
8 AWG	50A	48A	45A	37A
12AWG Double Crimp	40A (20A per wire)	40A (20A per wire)		

Note: CSA ratings are as follows; 12AWG = 23A max., 10AWG = 30A max.

TUV ratings are as follows; 12AWG = 23A max., 10AWG = 33A max.

**PCB trace design may greatly effect temperature rise results.

Dual Row Product (tested to 30degC max. rise)

	6ckt. W to W	6ckt. W to PCB**	14ckt W to W	14ckt. W to PCB**
16 AWG	13A	13A	13A	12A
14 AWG	17A	17A	17A	16A
12 AWG	23A	23A	23A	22A
10 AWG	32A	31A	29A	28A
8 AWG	43A	37A	38A	36A

**PCB trace design may greatly affect temperature rise results.

4.3 TEMPERATURES

Operating: -40 Degrees C to +105 Degrees C

Nonoperating: -40 Degrees C to +105 Degrees C

(Including 30 degrees C terminal temperature at full current)

REVISION: 15	ECR/ECN INFORMATION: EC No: UCP2004-0403 DATE: 2003 / 08 / 29	TITLE: PRODUCT SPECIFICATION FOR MINI-FIT SR. CONNECTOR SYSTEM	SHEET No. 2 of 8
DOCUMENT NUMBER: PS-42815-001	CREATED / REVISED BY: M. CARRANZA	CHECKED BY: J. COMERCI	APPROVED BY: J. COMERCI



PRODUCT SPECIFICATION

5.0 PERFORMANCE

5.1 ELECTRICAL PERFORMANCE

Section	Item	Test Condition	Requirement
5.1.1	Initial Contact Resistance (low level)	Mate connectors, measure by dry circuit, 20mV max., 100mA. Wire resistance shall be removed from the measured value.	1.5 mOhm max. (tin) 1.0 mOhm max. (gold)
5.1.2	Insulation Resistance	Mate connectors, apply 500V DC between adjacent terminal or ground.	1000 M Ohm min.
5.1.3	Dielectric Strength	Mate connectors, apply 2200V AC for 1 minute between adjacent terminal or ground.	No breakdown
5.1.4	Contact Resistance (rated)	Measure contact resistance at rated current.	1.5 mOhm max. (tin) 1.0 mOhm max. (gold)
5.1.5	Contact Resistance on Crimp	Crimp the wire to the terminal, measure crimp resistance by dry circuit, 20mV max., 100mA	1.0 mOhm max.

<u>REVISION:</u> 15	<u>ECR/ECN INFORMATION:</u> EC No: UCP2004-0403 DATE: 2003 / 08 / 29	<u>TITLE:</u> PRODUCT SPECIFICATION FOR MINI-FIT SR. CONNECTOR SYSTEM	<u>SHEET No.</u> 3 of 8
<u>DOCUMENT NUMBER:</u> PS-42815-001	<u>CREATED / REVISED BY:</u> M. CARRANZA	<u>CHECKED BY:</u> J. COMERCI	<u>APPROVED BY:</u> J. COMERCI



PRODUCT SPECIFICATION

5.2 MECHANICAL PERFORMANCE

Section	Item	Test Condition	Requirement
5.2.1	Contact Insertion and Withdrawal	Insert and withdraw a contact at a speed rate of 25 +/- 6mm / minute	Max. Insertion = 3Kg Min. Withdrawal = 0.5Kg
5.2.2	Connector Insertion and Withdrawal	Insert and withdraw a connector at a rate of 25 +/- 6mm / minute	Max. Insertion = 3.0Kg/ckt. Min. Withdrawal = 0.5Kg/ckt.
5.2.3	Terminal Insertion Force	Insert the crimped terminal into the housing.	Max. Insertion = 7.0Kg
5.2.4	Crimp Terminal Retention Force	Apply axial pull out force at a speed rate of 25 +/- 6mm / minute on the terminal assembled in the housing and with the TPA cover installed.	Min. Retention = 10Kg
5.2.5	Header Terminal Retention Force	Apply axial pull out force at a speed rate of 25 +/- 6mm / minute on the terminal assembled in the housing.	Min. Retention = 2.0Kg
5.2.6	Wire Pull Out Force	Mount the crimped terminal, apply an axial pull out force on the wire at a speed rate of 25 +/- 6mm / minute.	16AWG = 14Kg 14AWG = 23Kg 12AWG = 31Kg 10AWG = 36Kg 8AWG = 40Kg
5.2.7	Normal Force	Apply a perpendicular force at a speed rate of 25 +/- 6mm / minute.	200 g min.
5.2.8	PCB Insertion and Withdrawal Force	Apply force perpendicular to the housing at a speed rate of 25 +/- 6mm minute as shown.	Insertion = 2Kg max. Withdrawal = 1Kg min.
5.2.9	Panel Insertion & Withdrawal	Insert and withdraw a connector at a speed rate of 25 +/- 6mm / minute	Insertion = 5Kg max. Withdrawal = 10Kg min.

<u>REVISION:</u> 15	<u>ECR/ECN INFORMATION:</u> EC No: UCP2004-0403 DATE: 2003 / 08 / 29	<u>TITLE:</u> PRODUCT SPECIFICATION FOR MINI-FIT SR. CONNECTOR SYSTEM	<u>SHEET No.</u> 4 of 8
<u>DOCUMENT NUMBER:</u> PS-42815-001	<u>CREATED / REVISED BY:</u> M. CARRANZA	<u>CHECKED BY:</u> J. COMERCI	<u>APPROVED BY:</u> J. COMERCI



PRODUCT SPECIFICATION

5.2 MECHANICAL PERFORMANCE (continued)

Section	Item	Test Condition	Requirement
5.2.10	Latch Yield Strength (only 43914 receptacle w/ 43938 plug)	Insert and withdraw connector housings (30 times) and pull apart at a speed rate of 25 +/- 6mm / minute	Yield = 7.0Kg min.
5.2.10A	Latch Yield Strength (all other)	Insert and withdraw connector housings (30 times) and pull apart at a speed rate of 25 +/- 6mm / minute	Yield = 10.0Kg min.
5.2.11	Durability (tin)	Insert and withdraw connectors (30 times) at a maximum rate of 10 cycles per minute prior to environmental tests.	Contact Res. change = 1.0mOhm max.
5.2.11A	Durability (gold)	Insert and withdraw connectors (100 times) at a maximum rate of 10 cycles per minute prior to environmental tests.	Contact Res. change = 1.0mOhm max.
5.2.12	Vibration without lubrication (tin) Not Recommended	(30 times) at a maximum rate of 10 cycles per minute prior to environmental tests.	Contact Res change =. 4.0mOhm max Discontinuity not greater than 1 microsecond
5.2.12A	Vibration with lubrication (tin) (Nyogel 760G)	Amplitude: 1.50 mm peak to peak Sweep: 10-50-10 Hz in one minute Duration: 2 hours in each X-Y-Z axis.	Contact Res change =. 1.0mOhm max Discontinuity not greater than 1 microsecond
5.2.12B	Vibration without lubrication (gold)	Amplitude: 1.50 mm peak to peak Sweep: 10-55-10 Hz in one minute Duration: 2 hours in each X-Y-Z axis.	Contact Res change =. 1.0mOhm max Discontinuity not greater than 1 microsecond
5.2.13	Mechanical Shock	Sweep: 10-50-10 Hz in one minute Duration: 2 hours in each X-Y-Z axis.	Contact Res. change = 1.0mOhm max. Discontinuity not greater than 1 microsecond

<u>REVISION:</u> 15	<u>ECR/ECN INFORMATION:</u> EC No: UCP2004-0403 DATE: 2003 / 08 / 29	<u>TITLE:</u> PRODUCT SPECIFICATION FOR MINI-FIT SR. CONNECTOR SYSTEM	<u>SHEET No.</u> 5 of 8
<u>DOCUMENT NUMBER:</u> PS-42815-001	<u>CREATED / REVISED BY:</u> M. CARRANZA	<u>CHECKED BY:</u> J. COMERCI	<u>APPROVED BY:</u> J. COMERCI



PRODUCT SPECIFICATION

5.3 ENVIRONMENTAL PERFORMANCE

Section	Item	Test Condition	Requirement
5.3.1	Cold Resistance	-40 +/- 3 degrees C for 96 hrs.	Appearance: No damage Contact Res. change = 1.0mOhm max.
5.3.2	Thermal Shock	Mate connectors, expose to 25 cycles of: -40 +0/-3 deg. C for 30 minutes +25 +/- 10 deg. C for 5 minutes max. +105 +3/-0 deg. C for 30 minutes +25 +/- 10 deg. C for 5 minutes max.	Appearance: No damage Contact Res. change = 1.0mOhm max.
5.3.3	Thermal Aging	Mate connectors, expose to 240 hours at 105 +/- 2 deg. C	Appearance: No damage Contact Res. change = 1.0mOhm max
5.3.4	Humidity (Steady State)	Mate connectors, expose to a temperature of 40 +/- 2 deg. C with a relative humidity of 90% to 95% for 96 hours.	Appearance: No damage Contact Res. change = 1.0mOhm max Dielectric withstanding voltage: No breakdown Insul. res: 1000M Ohm min.
5.3.5	Humidity (cyclic) without lubrication Not Recommended	Mate connectors, expose to 25 cycles at 90% to 95% relative humidity with a transition time of 2.5 hrs. between extremes. +25 +/- 10 deg. C for 5 minutes max. +65 +3/-0 deg. C for 30 minutes	Appearance: No damage Contact Res. change = 2.0mOhm max Dielectric withstanding voltage: No breakdown Insul. res: 1000M Ohm min.

<u>REVISION:</u> 15	<u>ECR/ECN INFORMATION:</u> EC No: UCP2004-0403 DATE: 2003 / 08 / 29	<u>TITLE:</u> PRODUCT SPECIFICATION FOR MINI-FIT SR. CONNECTOR SYSTEM	<u>SHEET No.</u> 6 of 8
<u>DOCUMENT NUMBER:</u> PS-42815-001	<u>CREATED / REVISED BY:</u> M. CARRANZA	<u>CHECKED BY:</u> J. COMERCI	<u>APPROVED BY:</u> J. COMERCI



PRODUCT SPECIFICATION

5.3 ENVIRONMENTAL PERFORMANCE (cont.)

Section	Item	Test Condition	Requirement
5.3.6	Immunity to Fretting Corrosion without lubrication. (tin) Not Recommended	Mate connectors, expose to 500 cycles with a max. transition time of 5 minutes between extremes. +25 +/- 10 deg. C for 30 minutes +70 +3/-0 deg. C for 30 minutes	Appearance: No damage Contact Res. change = 4.0mOhm max
5.3.6A	Immunity to Fretting Corrosion with lubrication. (tin) (Nyogel 760G)	Mate connectors, expose to 500 cycles with a max. transition time of 5 minutes between extremes. +25 +/- 10 deg. C for 30 minutes +70 +3/-0 deg. C for 30 minutes	Appearance: No damage Contact Res. change = 1.0mOhm max
5.3.7	Temp. Rise & Current Cycling	Mate the connectors and measure the temperature rise at the rated current for 96 hrs., 45 minutes ON and 15 minutes OFF for 240 hrs., and an additional 96 hrs. of steady-state current.	Max. Temp. Rise = 30deg. C Per EIA 364 and CSA requirement
5.3.8	Solderability**	Solder time: 3 +/- 5 seconds Solder temp.: 260 +/- 5 deg. C	95% of the immersed area must show no voids or pin holes.
5.3.9	IR Process Resistance	245 +/- 3 deg. C for 4 minutes, allow to cool to room temperature, repeat for 3 cycles.	Appearance: No damage Dimensional: Conformance to sales drawing requirements.
5.3.10	Resistance to Solder**	Solder time: 3 +/- 0.5 seconds Solder temp.: 260 +/- deg. C	Appearance: No damage

**NOTE: This product is compatible with lead-free hand soldering temperatures.

REVISION: 15	ECR/ECN INFORMATION: EC No: UCP2004-0403 DATE: 2003 / 08 / 29	TITLE: PRODUCT SPECIFICATION FOR MINI-FIT SR. CONNECTOR SYSTEM	SHEET No. 7 of 8
DOCUMENT NUMBER: PS-42815-001	CREATED / REVISED BY: M. CARRANZA	CHECKED BY: J. COMERCI	APPROVED BY: J. COMERCI



PRODUCT SPECIFICATION

5.3 ENVIRONMENTAL PERFORMANCE (cont.)

Section	Item	Test Condition	Requirement
5.3.11	Resistance to Solvents	Solvent: flourinert FC-70 (3M Corp.) Solvent temp: Boiling temp. Immersion time: 120 +/- 5 seconds Solvent: Alpha 1003 (Alpha Metal) Solvent: Isopropyl Alcohol Solvent Temp.: Boiling temp. Immersion time: 240 +/- 5 seconds Repeat in solvent 5 times. Rinse with deionized water between cycles.	Appearance: No damage

<u>REVISION:</u> 15	<u>ECR/ECN INFORMATION:</u> EC No: UCP2004-0403 DATE: 2003 / 08 / 29	<u>TITLE:</u> PRODUCT SPECIFICATION FOR MINI-FIT SR. CONNECTOR SYSTEM	<u>SHEET No.</u> 8 of 8
<u>DOCUMENT NUMBER:</u> PS-42815-001	<u>CREATED / REVISED BY:</u> M. CARRANZA	<u>CHECKED BY:</u> J. COMERCI	<u>APPROVED BY:</u> J. COMERCI

ITEM NUMBER	CKT. SIZE	DIM. 'A'	DIM. 'B'	DIM. 'C'	TERMINAL PLATING
42820-2212	2	.138/(3.50)	.823/(20.90)	.071/(1.80)	
42820-2219	2	.138/(3.50)	.823/(20.90)	.071/(1.80)	
42820-2222	2	.201/(5.10)	.823/(20.90)	.102/(2.60)	
42820-2232	2	.201/(5.10)	.823/(20.90)	.134/(3.40)	
42820-2239	2	.201/(5.10)	.823/(20.90)	.134/(3.40)	
42820-2242	2	.327/(8.30)	.823/(20.90)	.259/(6.58)	
42820-3212	3	.138/(3.50)	1.217/(30.90)	.071/(1.80)	
42820-3222	3	.201/(5.10)	1.217/(30.90)	.102/(2.60)	
42820-3229	3	.201/(5.10)	1.217/(30.90)	.102/(2.60)	
42820-3232	3	.201/(5.10)	1.217/(30.90)	.134/(3.40)	
42820-3242	3	.327/(8.30)	1.217/(30.90)	.259/(6.58)	
42820-4212	4	.138/(3.50)	1.610/(40.90)	.071/(1.80)	
42820-4222	4	.201/(5.10)	1.610/(40.90)	.102/(2.60)	
42820-4232	4	.201/(5.10)	1.610/(40.90)	.134/(3.40)	
42820-4242	4	.327/(8.30)	1.610/(40.90)	.259/(6.58)	
42820-5212	5	.138/(3.50)	2.004/(50.90)	.071/(1.80)	
42820-5222	5	.201/(5.10)	2.004/(50.90)	.102/(2.60)	
42820-5232	5	.201/(5.10)	2.004/(50.90)	.134/(3.40)	
42820-5242	5	.327/(8.30)	2.004/(50.90)	.259/(6.58)	
42820-6212	6	.138/(3.50)	2.389/(60.90)	.071/(1.80)	
42820-6222	6	.201/(5.10)	2.389/(60.90)	.102/(2.60)	
42820-6229	6	.201/(5.10)	2.389/(60.90)	.102/(2.60)	
42820-6232	6	.201/(5.10)	2.389/(60.90)	.134/(3.40)	
42820-6242	6	.327/(8.30)	2.389/(60.90)	.259/(6.58)	
42820-2332	2	.201/(5.10)	.823/(20.90)	N/A	
42820-2342	2	.327/(8.30)	.823/(20.90)	N/A	
42820-2213	2	.138/(3.50)	.823/(20.90)	.071/(1.80)	
42820-2223	2	.201/(5.10)	.823/(20.90)	.102/(2.60)	
42820-2233	2	.201/(5.10)	.823/(20.90)	.134/(3.40)	
42820-2243	2	.327/(8.30)	.823/(20.90)	.259/(6.58)	
42820-3213	3	.138/(3.50)	1.217/(30.90)	.071/(1.80)	
42820-3223	3	.201/(5.10)	1.217/(30.90)	.102/(2.60)	
42820-3233	3	.201/(5.10)	1.217/(30.90)	.134/(3.40)	
42820-3243	3	.327/(8.30)	1.217/(30.90)	.259/(6.58)	
42820-4213	4	.138/(3.50)	1.610/(40.90)	.071/(1.80)	
42820-4223	4	.201/(5.10)	1.610/(40.90)	.102/(2.60)	
42820-4233	4	.201/(5.10)	1.610/(40.90)	.134/(3.40)	
42820-4243	4	.327/(8.30)	1.610/(40.90)	.259/(6.58)	
42820-5213	5	.138/(3.50)	2.004/(50.90)	.071/(1.80)	
42820-5223	5	.201/(5.10)	2.004/(50.90)	.102/(2.60)	
42820-5233	5	.201/(5.10)	2.004/(50.90)	.134/(3.40)	
42820-5243	5	.327/(8.30)	2.004/(50.90)	.259/(6.58)	
42820-6213	6	.138/(3.50)	2.389/(60.90)	.071/(1.80)	
42820-6223	6	.201/(5.10)	2.389/(60.90)	.102/(2.60)	
42820-6233	6	.201/(5.10)	2.389/(60.90)	.134/(3.40)	
42820-6243	6	.327/(8.30)	2.389/(60.90)	.259/(6.58)	

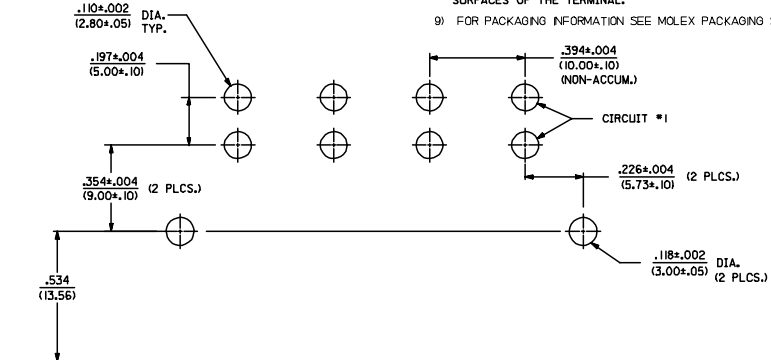
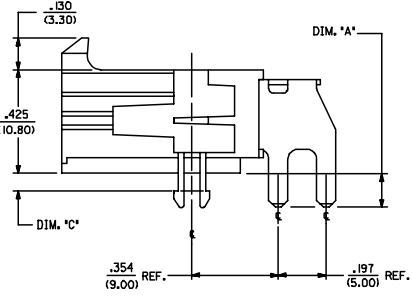
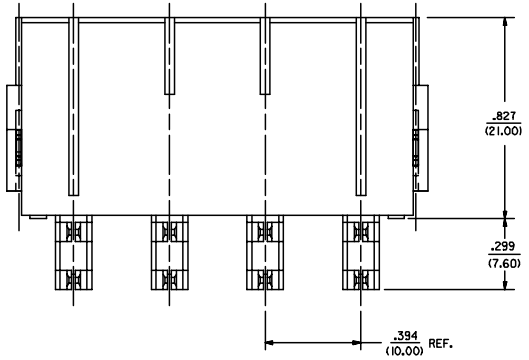
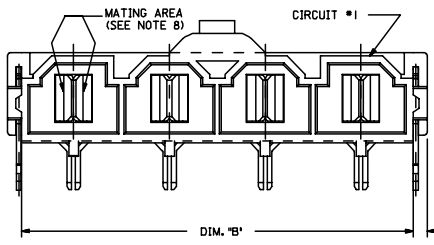

RECOMMENDED P.C. BOARD PLATED-THRU HOLE LAYOUT
(4 CKT. SHOWN FOR REF.)

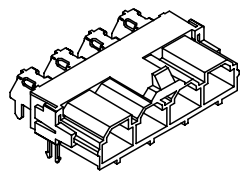

HEADER WITH RT. ANGLE TERMINAL & CLIP
ISO VIEW

LEGEND:

- A-42820 -
- CIRCUIT SIZE (2-6)
- MOUNTING OPTION
 - 1 = FLANGES (SEE DWG. SDA-42820-1**)
 - 2 = RETENTION CLIP
 - 3 = NO RETENTION CLIP
- P.C. BOARD THICKNESS
 - 1 = .062 (1.57) NOMINAL
 - 2 = .093 (2.36) NOMINAL
 - 3 = .125 (3.18) NOMINAL
 - 4 = .250 (6.35) NOMINAL
- PLATING
 - 2 OR 9 = OVERALL TIN OVER NICKEL
 - 3 = SELECT GOLD IN CONTACT AREA
SELECT TIN ON SOLDER TAILS
OVER NICKEL

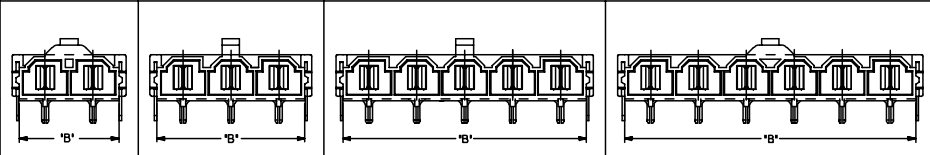

ADDED -3229 EC NO: UCP2007-0946 DRAWN: JOMERL 2004/10/18 CHKD: JOMERL 2004/10/18 APPR: JOMERL 2004/10/19 DESCRIPTION	QUALITY SYMBOLS	GENERAL TOLERANCES (UNLESS SPECIFIED)	DIMENSION STYLE IN/MM	SCALE 4:1	DESIGN UNITS METRIC	THIRD ANGLE PROJECTION
	$\nabla=0$ $\nabla=0$	4 PLACES \pm --- \pm --- 3 PLACES \pm --- \pm --- 2 PLACES ± 0.25 \pm --- 1 PLACE ± 0.40 \pm --- ANGULAR $\pm 1/2^\circ$	DRAWN BY DATE KSM 1/4/96 CHECKED BY DATE SF 1/4/96 APPROVED BY DATE SF 1/4/96	TITLE		
	DRAFT WHERE APPLICABLE MUST REMAIN WITHIN DIMENSIONS	SEE CHART		RIGHT ANGLE HEADER ASSEMBLY MINIFIT SR. SERIES		
				MOLEX INCORPORATED		
			MATERIAL NO.	DOCUMENT NO. SDA-42820-0002	SHEET NO. 1 OF 1	