

20 19 18 17 16 15 14 13 12 11 10 9 8 7 6 5 4 3 2 1

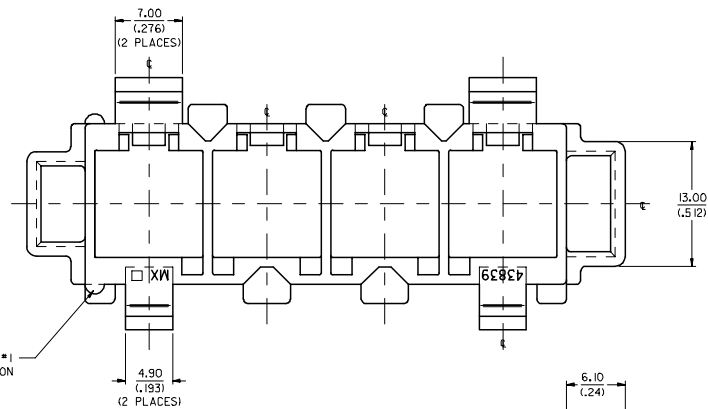

POSITION #1
DESIGNATION

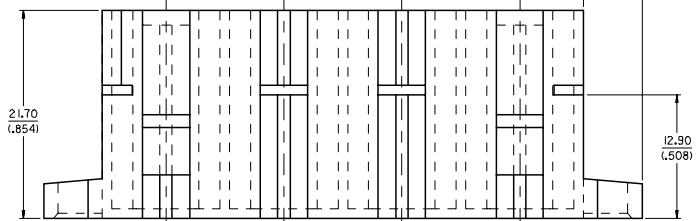

SEE NOTE 9

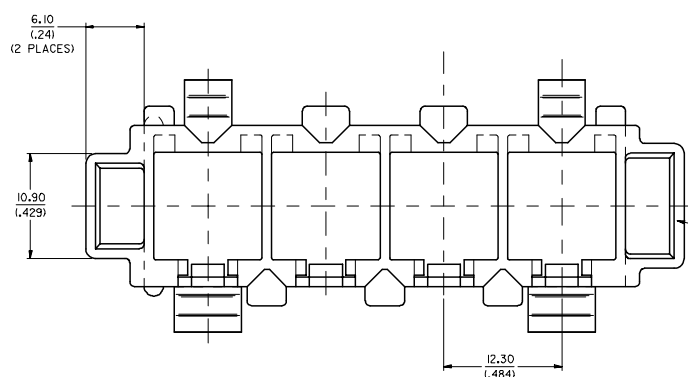
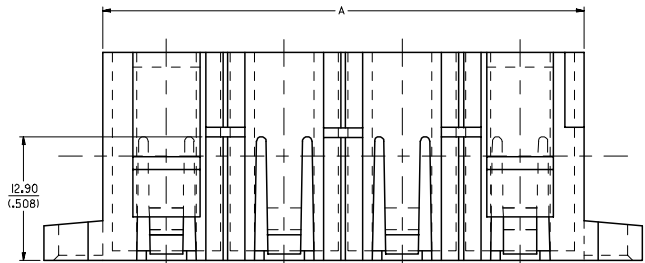
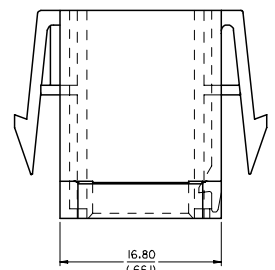

LATCHING AREA IS KEYED TO PREVENT IMPROPER MATING.

NOTES:

1. MATERIAL: POLYESTER (PBT), 7.5% GLASS FILLED, UL 94V-0. COLOR: BLACK
2. FINISH: NONE
3. PRODUCT SPEC. : PS-43510-002
4. ALL DIMENSIONS SHOWN FOR REFERENCE ONLY.
5. PART TO BE USED WITH PODS SHOWN IN CHART. SEE SHEET 2 FOR ASSEMBLY INFORMATION.
6. PODS MAY BE PLACED IN ANY POSITION DESIRED.
7. FOR RECOMMENDED PANEL OPENING, SEE SHEET 2.
8. PART MATES WITH 43838-0*** RECEPTACLE SHROUD.
9. MATED CONNECTOR ASSEMBLIES MUST BE UNMATED WITH A STRAIGHT PULL IN THE DIRECTION SHOWN TO PREVENT DAMAGE, AVOID ROTATING ASSEMBLIES DURING UNMATING.
10. SEE SHEET 2 FOR APPLICATION NOTES.

43516-0001	BLIND-MATE POD
43515-0001	6 CIRCUIT MICRO-FIT PLUG
43514-0001	4 CIRCUIT MINI-FIT JR. PLUG
43513-0001	1 CIRCUIT MINI-FIT SR. PLUG
MATERIAL NO.	DESCRIPTION

AVAILABLE PODS

	43839-0601	6	74.80 (2.945)
OBSOLETE	43839-0501	5	62.50 (2.461)
	43839-0401	4	50.20 (1.976)
	43839-0301	3	37.90 (1.492)
OBSOLETE	43839-0201	2	25.60 (1.007)
STATUS	MATERIAL NO.	POSITIONS	DIM. "A"

OBSOLETE PARTS
 IEC NO: UCP2005-2425
 DRAWN: COMERC 2005/05/11
 CHKCD: 2005/05/13
 APPR: COMERC 2005/05/16

QUALITY SYMBOLS	GENERAL TOLERANCES (UNLESS SPECIFIED)	DIMENSION STYLE	SCALE	DESIGN UNITS	THIRD ANGLE PROJECTION															
$\nabla=0$ $\nabla=0$	<table border="1"> <tr> <th></th> <th>mm</th> <th>INCH</th> </tr> <tr> <td>4 PLACES</td> <td>± .010</td> <td>± .004</td> </tr> <tr> <td>3 PLACES</td> <td>± .015</td> <td>± .006</td> </tr> <tr> <td>2 PLACES</td> <td>± .020</td> <td>± .008</td> </tr> <tr> <td>1 PLACE</td> <td>± .030</td> <td>± .012</td> </tr> </table>		mm	INCH	4 PLACES	± .010	± .004	3 PLACES	± .015	± .006	2 PLACES	± .020	± .008	1 PLACE	± .030	± .012	MM/IN	4:1	METRIC	<input checked="" type="checkbox"/>
	mm	INCH																		
4 PLACES	± .010	± .004																		
3 PLACES	± .015	± .006																		
2 PLACES	± .020	± .008																		
1 PLACE	± .030	± .012																		
		DRAWN BY: COMERC1	DATE: 10/6/97	PLUG SHROUD PANEL MOUNT MIXED LAYOUT																
		CHECKED BY: COMERC1	DATE: 10/6/97																	
		APPROVED BY: FRY	DATE: 10/10/97																	
		DRAFT WHERE APPLICABLE MUST REMAIN WITHIN DIMENSIONS		SEE CHART																

MOLEX INCORPORATED
 MATERIAL NO. SD-43839-001
 DOCUMENT NO. SD-43839-001
 SHEET NO. 1 OF 2

19 18 17 16 15 14 13 12 11 10 9 8 7 6 5 4 3 2 1

PANEL OPENING

POSITIONS	DIM. "B" ± 0.10 (± 0.004)	DIM. "C" ± 0.10 (± 0.004)
2	38.40 (1.512)	12.30 (.484)
3	50.70 (1.997)	24.60 (.969)
4	63.00 (2.480)	36.90 (1.453)
5	75.30 (2.965)	49.20 (1.937)
6	87.60 (3.449)	61.50 (2.421)

APPLICATION NOTES:

1. PLACE THE HIGH CURRENT MINI-FIT SR. PODS IN THE OUTER POSITIONS OF THE SHROUD TO MAXIMIZE CURRENT CARRYING CAPABILITY.
2. IF MORE THAN ONE MINI-FIT SR. POD IS USED, PLACE THEM AS FAR APART AS POSSIBLE IN THE SHROUD TO MAXIMIZE CURRENT CARRYING CAPABILITY.
3. REFER TO THE INDIVIDUAL PRODUCT'S PRODUCT SPECIFICATION FOR DETAILED PERFORMANCE CHARACTERISTICS OF EACH. (MINI-FIT JR., MINI-FIT SR., MICRO-FIT 3.0, ETC.)
4. THE SHROUD PROVIDES SYSTEM POLARIZATION. PODS MUST NEVER BE APPLIED WITHOUT THE USE OF THE SHROUD. 'MALE' AND 'FEMALE' PODS CAN BE INSERTED INTO EITHER SHROUD FOR ADDITIONAL CONNECTOR POLARIZATION. WHEN MULTIPLE COMPODRE SYSTEMS ARE USED IN A SINGLE APPLICATION, THE PODS MAY BE POSITIONED TO PROVIDE FOOLPROOF HARNESS TO HARNESS POLARIZATION.
5. 'PIG TAIL' OR HARNESS PODS CAN BE INSERTED INTO RIGHT ANGLE HEADER SHROUDS WHERE NECESSARY.
6. TO OBTAIN THE LOWEST POSSIBLE MATING FORCES OF A FULLY LOADED SHROUD, THE TERMINALS MUST BE ALLOWED TO FLOAT AS DESIGNED. ASSURE THAT THE TERMINALS ARE CRIMPED PROPERLY BY USING ONLY MOLEX TERMINALS AND PROPERLY MAINTAINED MOLEX AUTHORIZED APPLICATION TOOLING.
7. FOR PROPER MATING OF SHROUDS, THE POD LOCKING FINGERS ON BOTH SHROUDS MUST BE ORIENTED SUCH THAT THEY ARE ON THE SAME PLANE. WHEN MATING THE CONNECTORS, THE SIDE LATCHES OF THE SHROUD ARE DESIGNED TO PROVIDE POLARIZATION.
8. EACH SHROUD POD BAY IS KEYPED TO PROVIDE POLARIZATION. THE POD MUST BE INSTALLED IN THE DIRECTION SHOWN. WHEN INSERTING A POD INTO THE SHROUD, THE 'U' SHAPED FEATURE ON THE SIDE OF THE POD MUST BE ORIENTED TO THE SAME FACE AS THE POD LOCKING FINGERS ON THE SHROUD.
9. AS THE 'FACE TO FACE' MATING OF THE PODS IS CRITICAL TO ASSURE THAT ALL CONTACTS ARE FULLY 'WIPED', THE TOLERANCES OF THE SHROUD TO SHROUD MATING ARE TIGHTLY CONTROLLED. THEREFORE, WHEN SEATING A POD INTO A SHROUD, MAKE CERTAIN THAT THE SHROUD LOCKING FINGER IS FULLY SEATED INTO THE POD. IT MAY BE NECESSARY AT TIMES TO APPLY A SLIGHT VERTICAL FORCE TO THE LOCKING FINGER TO SEAT THE POD FULLY. ALSO, WHEN MATING TWO SHROUDS, ASSURE THAT THE SHROUD POSITIVE LOCKS, LOCATED ON THE SIDES OF THE SHROUD, ARE FULLY ENGAGED WITH THE MATING SHROUD.
10. PODS MAY BE REMOVED FROM SHROUDS IF REQUIRED. TO REMOVE A POD, SIMPLY DEFLECT THE LOCKING FINGER AWAY FROM THE POD, USING A FINGER NAIL OR A SMALL STRAIGHT BLADE SCREWDRIVER, JUST FAR ENOUGH TO DISENGAGE THE POD. CAUTION: EXCESSIVE DEFLECTION MAY DAMAGE OR DESTROY THE LOCKING FINGER.
11. THE SHROUD PROVIDES SYSTEM POLARIZATION. PODS MUST NEVER BE APPLIED WITHOUT THE USE OF A SHROUD.

INSERT PODS IN THIS DIRECTION
UNTIL FULLY LATCHED IN SHROUD.
SEE APPLICATION NOTES 8 & 9

PODS ARE KEYPED TO PREVENT IMPROPER ASSEMBLY.

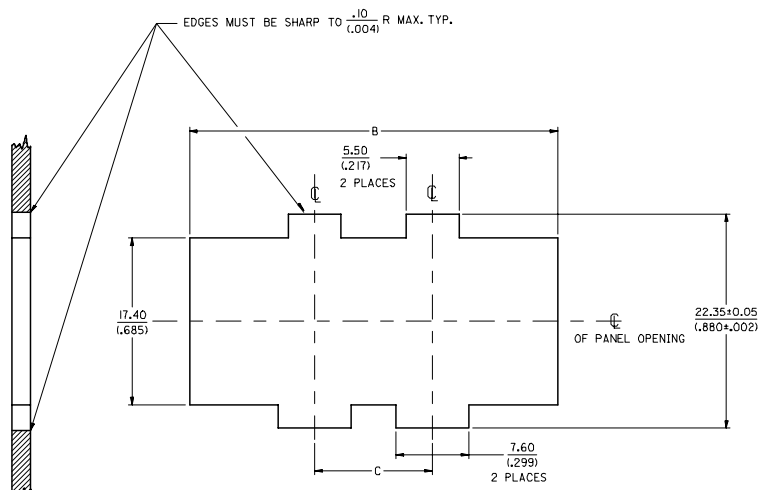
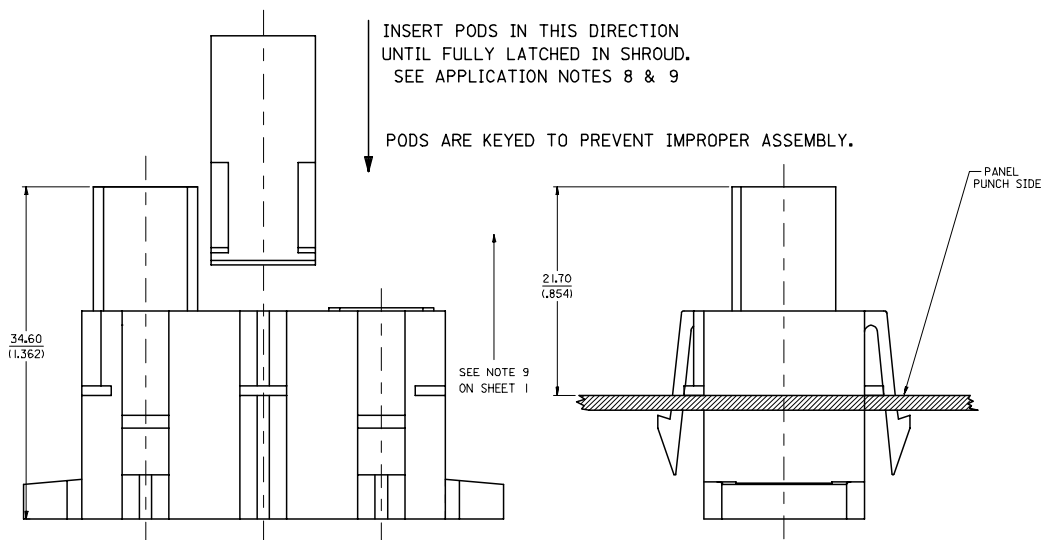

RECOMMENDED PANEL OPENING
FROM OUTSIDE OF BOX

PANEL THICKNESS: 1.57 TO 2.29
(0.062) TO (0.090)

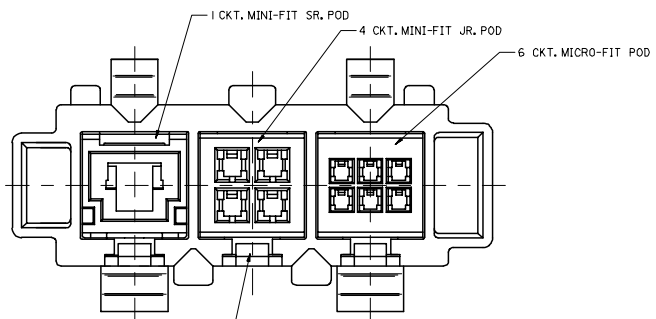

SEE SHT. 1 EC NO: UCP2005-2425 DRAWN: COMERC 2005/05/11 CHECK: CHKCD 2005/05/13 APPR: COMERC 2005/05/16 B1	QUALITY SYMBOLS ▽=0 ▽=0	GENERAL TOLERANCES (UNLESS SPECIFIED) mm ±--- ±--- INCH ±--- ±--- ANGULAR ±1/2°	DIMENSION STYLE MM/IN	SCALE 4:1	DESIGN UNITS METRIC	THIRD ANGLE PROJECTION	
	DRAWN BY COMERC 10/6/97	CHECKED BY COMERC 10/6/97	APPROVED BY FRY 10/10/97	DATE 10/6/97	DATE 10/6/97	DATE 10/10/97	TITLE PLUG SHROUD PANEL MOUNT MIXED LAYOUT
	MATERIAL NO.	SEE CHART	DOCUMENT NO. SD-43839-001	SHEET NO. 2 OF 2	MOLEX INCORPORATED		
	DRAFT WHERE APPLICABLE MUST REMAIN WITHIN DIMENSIONS						THIS DRAWING CONTAINS INFORMATION THAT IS PROPRIETARY TO MOLEX INCORPORATED AND SHOULD NOT BE USED WITHOUT WRITTEN PERMISSION