

10 9 8 7 6 5 4 3 2 1

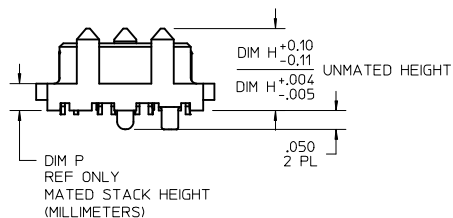

8 ROW  
10 POSITION  
SHOWN

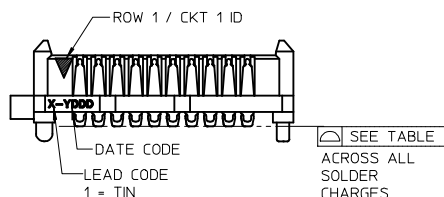
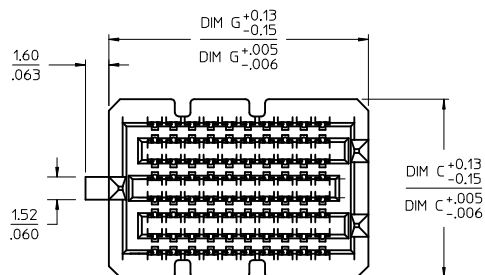
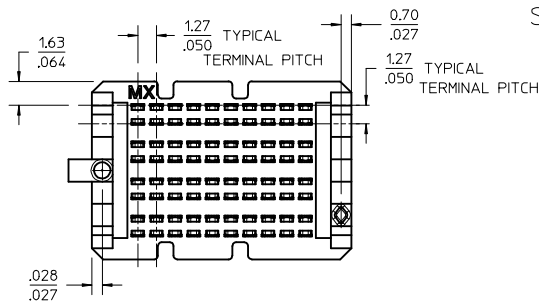

SEE SHEET 3  
FOR 6 ROW OPTION

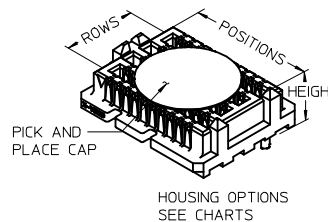

NOTES:

- MATERIAL: HOUSING: LCP, GLASS FILLED, UL94V-0, BLACK  
CONTACTS: COPPER ALLOY  
SOLDER CHARGE: 95.5% TIN, 3.8% SILVER, 0.7 % COPPER
- FINISH: ALL DIM P HEIGHT OPTIONS - SELECT GOLD IN CONTACT AREA: 30 MI MIN  
DIM P HEIGHT OPTIONS 2.0 & 2.5: SELECT GOLD FLASH IN TAIL, 7 MI MIN  
DIM P HEIGHT OPTIONS 3.0 THRU 7.0: SELECT TIN IN TAIL, 50 MI MIN  
ALL DIM P HEIGHT OPTIONS - NICKEL UNDERPLATE OVERALL
- PRODUCT SPECIFICATION: PS-45970-001
- PACKAGING SPECIFICATION: TRAY PACK PK-45971-001
- MATES WITH SEARAY RECEPTACLE ASSY 45971
- APPLICATION SPECIFICATION: AS-45970-001
- COSMETIC SPECIFICATION: PS-45499-002 CLASS B
- PART STATUS: CONTACT MOLEX

POSITION	
10	0.15/.006
20	0.15/.006
30	0.15/.006
40	0.15/.006
50	0.15/.006
15	0.15/.006
25	0.15/.006
35	0.23/.009
45	0.23/.009

ROWS: 10			
DIM R: (REF)	3.0 MM	3.5 MM	
DIM H:	6.60/.260	7.11/.280	
POSITION	DIM G	MATERIAL NO	MATERIAL NO
20	430.37/1.196	45970-3211	45970-2311
30	43.07/1.696	45970-3211	45970-4311
40	55.78/2.196		45970-4311

MATED STACK HEIGHTS  
GIVEN IN MILLIMETERS (MM) FOR REFERENCE ONLY

<b>INITIAL RELEASE</b> EC NO: UCP2015-1206 DRAWN/RWHIPPLE 2014/10/27 CHKCD:DMORGAN 2014/10/27 APPR:SMILLER 2015/01/05	QUALITY SYMBOLS $\nabla = 0$ $\nabla = 0$ $\nabla = 0$	GENERAL TOLERANCES (UNLESS SPECIFIED)	DIMENSION STYLE	SCALE	DESIGN UNITS	THIRD ANGLE PROJECTION
			MM/IN	3:1	INCH	
		4 PLACES ± --- ± ---	DRAWN BY	DATE	TITLE	
		3 PLACES ± --- ± .010	RWHIPPLE	2014/10/27	SEARAY, PLUG ASSEMBLY	
		2 PLACES ± 0.25 ± .015	CHECKED BY	DATE		
		1 PLACE ± 0.38 ± ---	DMORGAN	2014/10/27		
		0 PLACE ± ±	APPROVED BY	DATE		
			SMILLER	2015/01/05		
		ANGULAR ± --- °	MATERIAL NO.	DOCUMENT NO.		
		DRAFT WHERE APPLICABLE MUST REMAIN WITHIN DIMENSIONS	SEE TABLE	RSD-45970-002		
			SIZE B			
			THIS DRAWING CONTAINS INFORMATION THAT IS PROPRIETARY TO MOLEX INCORPORATED AND SHOULD NOT BE USED WITHOUT WRITTEN PERMISSION			

9 8 7 6 5 4 3 2 1

10 9 8 7 6 5 4 3 2 1

NO OF ROWS	DIM C	DIM E
6	.960/.378	.317/.125
8	1.21/.478	.444/.175
10	1.47/.578	5.72/.225

10 ROW  
10 POSITION  
SHOWN

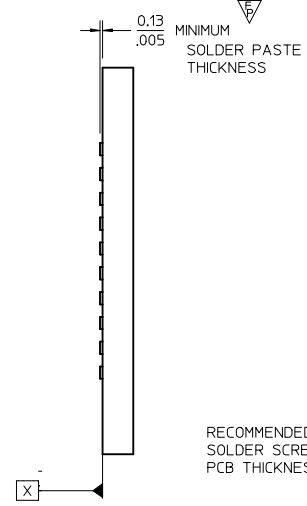
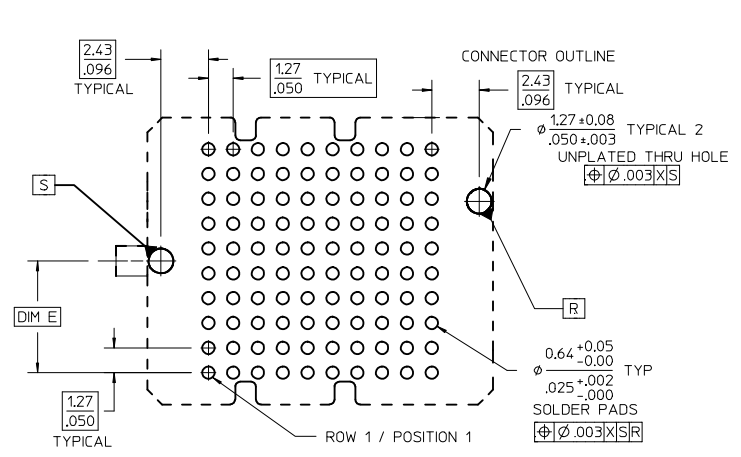

RECOMMENDED PCB LAYOUT: COMPONENT SIDE  
SOLDER SCREEN APERTURE SIZE: .890/.035 DIAMETER  
PCB THICKNESS: NA

		DIM R RECEPTACLE STACK HEIGHT					
		MM	5.0	6.0	6.5	7.5	8.0
DIM P PLUG STACK HEIGHT	2.0	7.0	8.0	8.5	9.5	10.0	
	3.0	8.0	9.0	9.5	10.5	11.0	
	3.5	8.5	9.5	10.0	11.0	11.5	
	2.5	7.5	8.5	9.0	10.0	10.5	
	4.5	9.5	10.5	11.0	12.0	12.5	
	5.0	10.0	11.0	11.5	12.5	13.0	
	7.0	12.0	13.0	13.5	14.5	15.0	
	9.0	14.0	15.0	15.5	16.5	17.0	

MATED STACK HEIGHTS  
GIVEN IN MILLIMETERS (MM) FOR REFERENCE ONLY

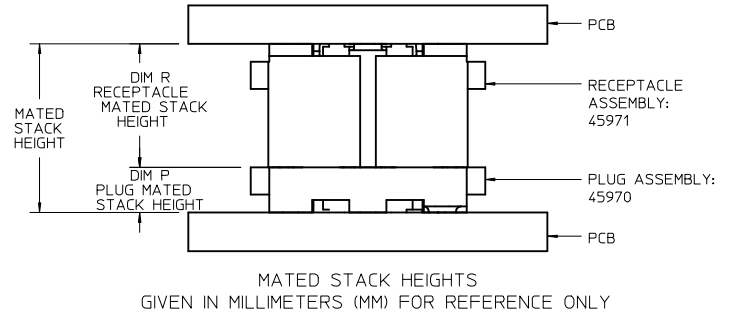

MATED STACK HEIGHTS  
GIVEN IN MILLIMETERS (MM) FOR REFERENCE ONLY

SEE SHEET 1 EC NO: UCP2015-1206 DRAWN: RWHIPPLE 2014/10/27 CHKD: DMORGAN 2014/10/27 APPR: SMILLER 2015/01/05	DESCRIPTION	QUALITY SYMBOLS	GENERAL TOLERANCES (UNLESS SPECIFIED)	DIMENSION STYLE	SCALE	DESIGN UNITS	THIRD ANGLE PROJECTION	
		$\nabla F/0$	mm INCH	MM/IN	4:1	INCH		
		$\nabla F/2$	4 PLACES ± --- ± ---	DRAWN BY DATE	RWHIPPLE 2014/10/27	TITLE	SEARAY, PLUG ASSEMBLY .050 CENTERS TRAY PACKAGING	
		$\nabla F/0$	3 PLACES ± --- ± .010	CHECKED BY DATE	DMORGAN 2014/10/27	molex		
	2 PLACES ± 0.25 ± .015	APPROVED BY DATE	SMILLER 2015/01/05	DOCUMENT NO.	RSD-45970-002			
		1 PLACE ± 0.38 ± ---	ANGULAR ± --- °		THIS DRAWING CONTAINS INFORMATION THAT IS PROPRIETARY TO MOLEX INCORPORATED AND SHOULD NOT BE USED WITHOUT WRITTEN PERMISSION			
		0 PLACE ± ±	DRAFT WHERE APPLICABLE MUST REMAIN WITHIN DIMENSIONS		SEE TABLE SHT 1			

9 8 7 6 5 4 3 2 1

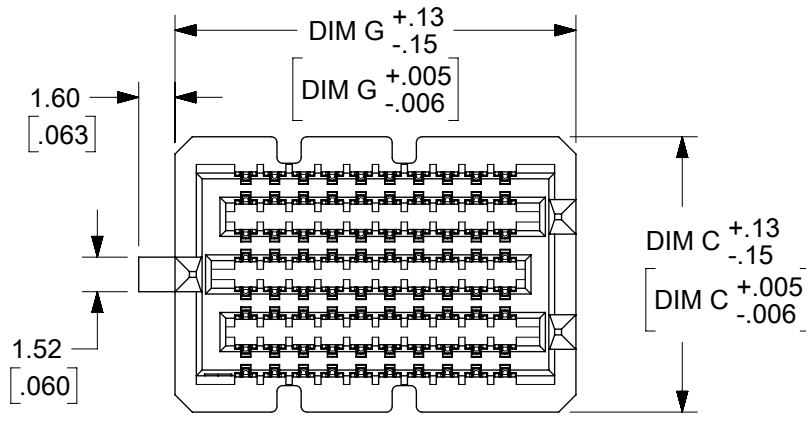

- NOTES:
- MATERIAL: HOUSING: GLASS FILLED LCP (LIQUID CRYSTAL POLYMER), UL94V-0, BLACK  
CONTACTS: COPPER ALLOY  
SOLDER CHARGE: 95.5% TIN, 3.8% SILVER, 0.7% COPPER
  - FINISH: ALL DIM P HEIGHT OPTIONS - SELECT GOLD IN CONTACT AREA: 30 MICROINCH MINIMUM  
DIM P HEIGHT OPTIONS 2.0 & 2.5: SELECT GOLD FLASH ON TAIL, 7 MICROINCH MINIMUM  
DIM P HEIGHT OPTIONS 3.0 THRU 7.0: SELECT TIN ON TAIL, 50 MICROINCH MINIMUM  
ALL OPTIONS - NICKEL UNDERPLATE OVERALL ON TAIL
  - PRODUCT SPECIFICATION: PS-45970-001
  - PACKAGING SPECIFICATION: PK-45970-002 (TAPE AND REEL)
  - MATES WITH SEARAY RECEPTACLE ASSEMBLY SERIES 45971
  - APPLICATION SPECIFICATION; AS-45970-001
  - COSMETIC SPECIFICATION: PS-45499-002 CLASS B
  - PART STATUS: CONTACT MOLEX

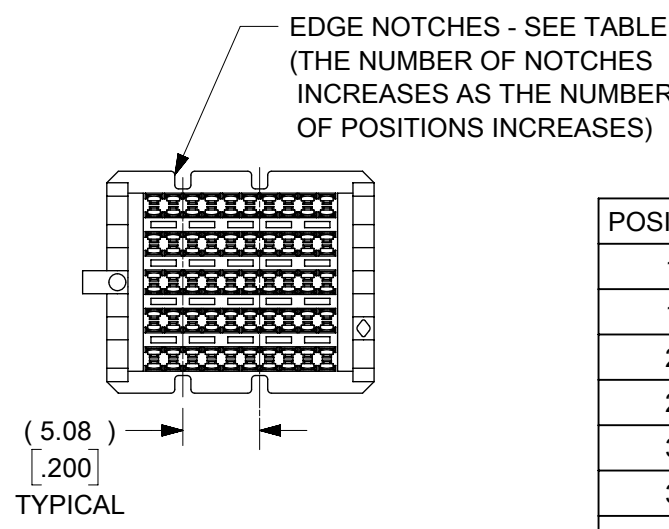
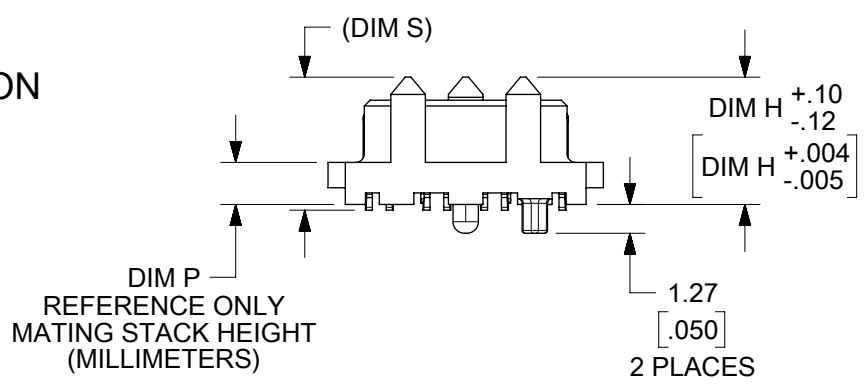
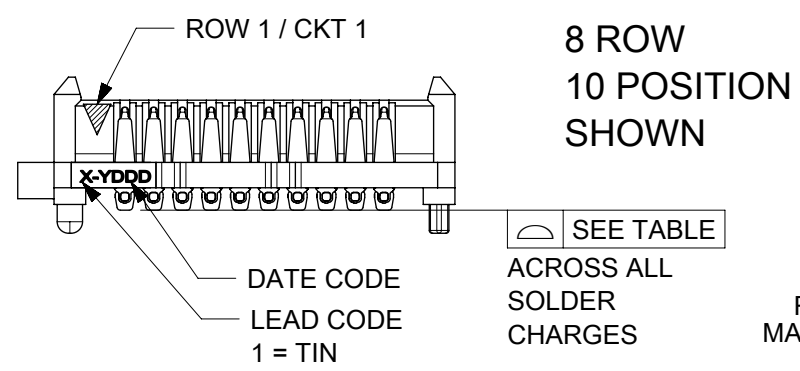

POSITIONS	TOTAL NUMBER OF EDGE NOTCHES		Symbol
	8 ROW	6 AND 10 ROW	
10	4	4	0.15/.006
15	6	6	
20	10	10	
25	12	12	
30	14	14	
35	16	16	
40	18	20	0.23/.009
45	22	22	
50	24	24	

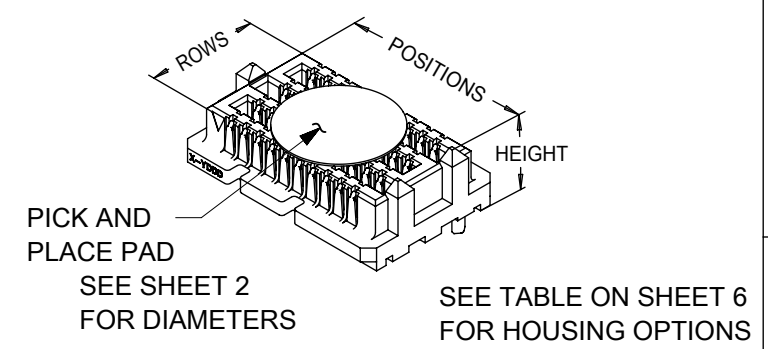
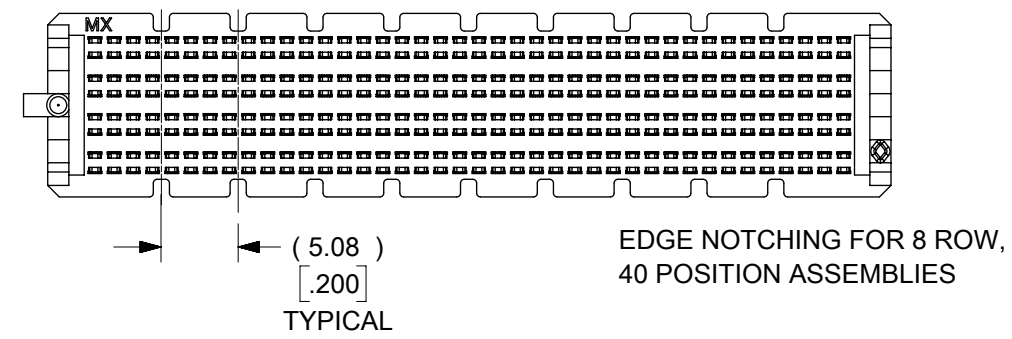
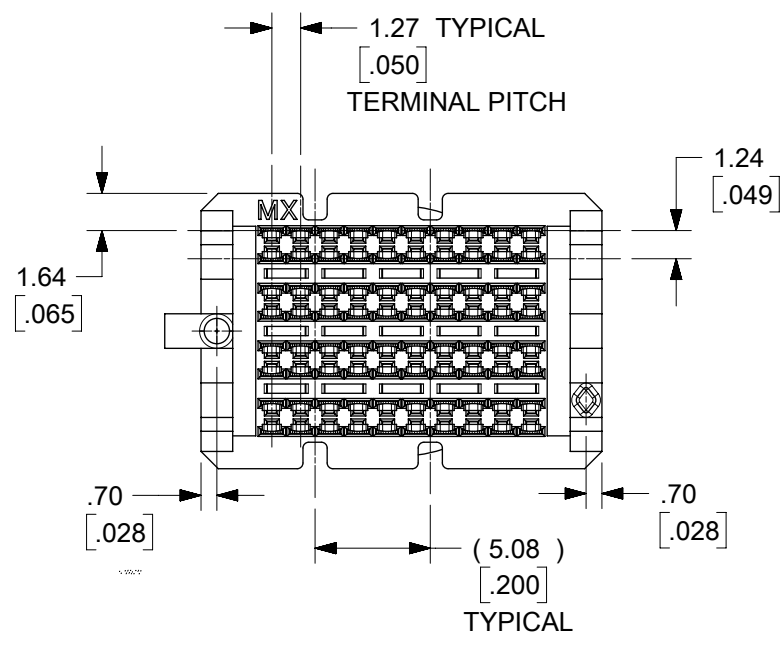

SEE OTHER EDGE NOTCHING VIEWS  
SEE SHEET 3  
FOR 6 ROW OPTION

THIS DRAWING CONTAINS INFORMATION THAT IS PROPRIETARY TO MOLEX ELECTRONIC TECHNOLOGIES, LLC AND SHOULD NOT BE USED WITHOUT WRITTEN PERMISSION									
SYMBOLS		DIMENSION UNITS	SCALE	CURRENT REV DESC: SEE REV TABLE SHT 7					
▽ = 0		mm	4:1	<b>molex</b> SEARAY PLUG ASSEMBLY 1.27/.050 CENTERS PRODUCT CUSTOMER DRAWING					
▽ = 0		GENERAL TOLERANCES (UNLESS SPECIFIED)							
▽ = 0		ANGULAR TOL ± °							
▽ = 0		4 PLACES ±							
▽ = 0		3 PLACES ±							
▽ = 0		2 PLACES ± 0.25		EC NO: 617843		DRWN: PMAHADEVAPPA 2019/05/24		CHK'D: DMCGOWAN 2019/05/24	
▽ = 0		1 PLACE ± 0.38		APPR: DMCGOWAN 2019/05/24		INITIAL REVISION:		DOCUMENT NUMBER	
▽ = 0		0 PLACES ±		DRWN: TGREGORI 2006/01/25		APPR: JCOMERCI 2006/01/30		SD-45970-001	
■ = 0		DRAFT WHERE APPLICABLE MUST REMAIN WITHIN DIMENSIONS		THIRD ANGLE PROJECTION		DRAWING		SERIES	
▽ = 0				B-SIZE		45970		MATERIAL NUMBER	
				SEE CHART		CUSTOMER		REVISION	
				GENERAL MARKET		1 OF 7		T6	

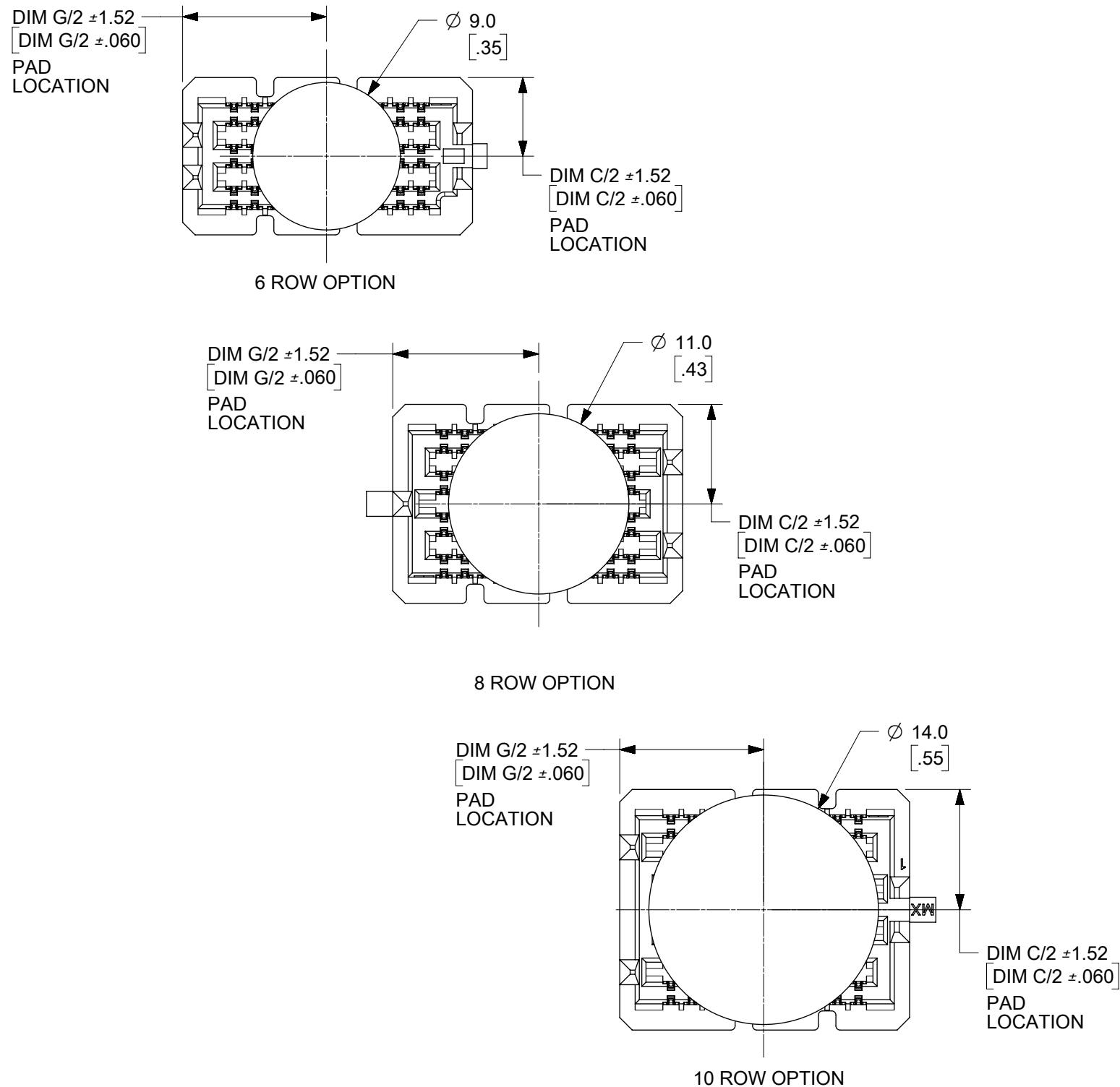

**PICK AND PLACE  
PAD DIAMETERS**  
10 POSITION VERSIONS SHOWN

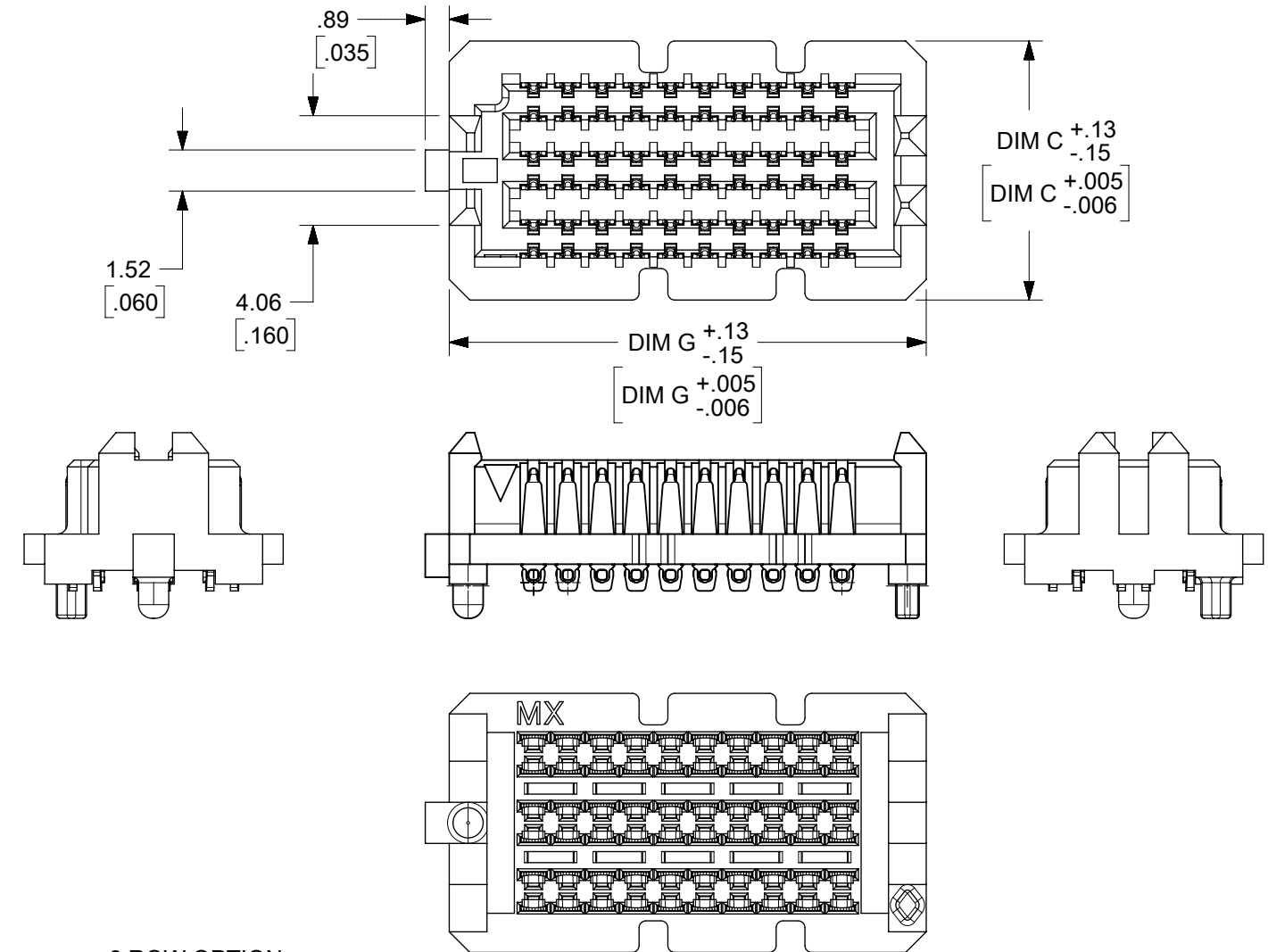

**6 ROW OPTION**  
10 POSITION VERSION  
SHOWN FOR REFERENCE

DIMENSIONS SHOWN ON  
OTHER SHEETS APPLY TO  
THE 6 ROW OPTION ALSO  
(EXCEPT AS OTHERWISE  
NOTED ON THIS SHEET)

THIS DRAWING CONTAINS INFORMATION THAT IS PROPRIETARY TO MOLEX ELECTRONIC TECHNOLOGIES, LLC AND SHOULD NOT BE USED WITHOUT WRITTEN PERMISSION											
SYMBOLS		DIMENSION UNITS		SCALE		CURRENT REV DESC: SEE REV TABLE SHT 7					
▽ = 0		mm		2:1		<b>molex</b> SEARAY PLUG ASSEMBLY 1.27/.050 CENTERS PRODUCT CUSTOMER DRAWING DOCUMENT NUMBER: SD-45970-001   DOC TYPE: PSD   DOC PART: 001   REVISION: T6 EC NO: 617843 DRWN: PMAHADEVAPPA 2019/05/24 CHK'D: DMCGOWAN 2019/05/24 APPR: DMCGOWAN 2019/05/24 INITIAL REVISION: DRWN: TGREGORI 2006/01/25 APPR: JCOMERCI 2006/01/30 MATERIAL NUMBER: SEE CHART   CUSTOMER: GENERAL MARKET   SHEET NUMBER: 2 OF 7					
▽ = 0		GENERAL TOLERANCES (UNLESS SPECIFIED)									
▽ = 0		ANGULAR TOL ± °									
▽ = 0		4 PLACES ±									
▽ = 0		3 PLACES ±									
▽ = 0		2 PLACES ± 0.25									
▽ = 0		1 PLACE ± 0.38									
▽ = 0		0 PLACES ±									
▽ = 0		DRAFT WHERE APPLICABLE MUST REMAIN WITHIN DIMENSIONS		THIRD ANGLE PROJECTION		DRAWING		SERIES		MATERIAL NUMBER	
▽ = 0				B-SIZE		45970		SEE CHART		GENERAL MARKET	

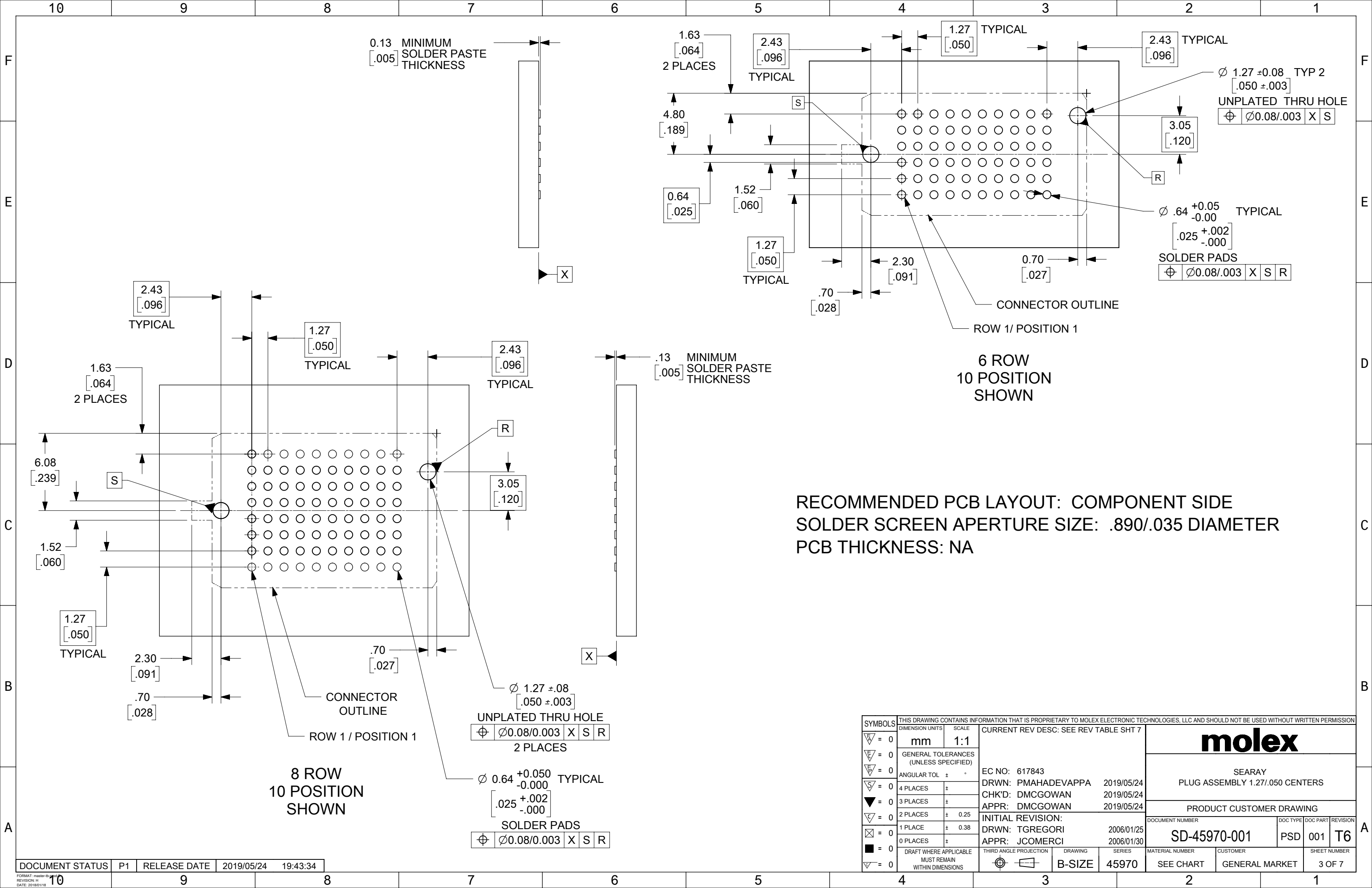

SYMBOLS		THIS DRAWING CONTAINS INFORMATION THAT IS PROPRIETARY TO MOLEX ELECTRONIC TECHNOLOGIES, LLC AND SHOULD NOT BE USED WITHOUT WRITTEN PERMISSION	
▽ = 0	DIMENSION UNITS	SCALE	CURRENT REV DESC: SEE REV TABLE SHT 7
▽ = 0	mm	1:1	
▽ = 0	GENERAL TOLERANCES (UNLESS SPECIFIED)		
▽ = 0	ANGULAR TOL	±	°
▽ = 0	4 PLACES	±	
▽ = 0	3 PLACES	±	
▽ = 0	2 PLACES	±	0.25
▽ = 0	1 PLACE	±	0.38
▽ = 0	0 PLACES	±	
▽ = 0	DRAFT WHERE APPLICABLE MUST REMAIN WITHIN DIMENSIONS		
▽ = 0	THIRD ANGLE PROJECTION	DRAWING	SERIES
▽ = 0	⊕	B-SIZE	45970
EC NO: 617843		DRWN: PMAHADEVAPPA 2019/05/24	
CHK'D: DMCGOWAN 2019/05/24		APPR: DMCGOWAN 2019/05/24	
INITIAL REVISION:		2006/01/25	
DRWN: TGREGORI		2006/01/30	
APPR: JCOMERCI		2006/01/30	
DOCUMENT NUMBER		DOC TYPE	DOC PART
SD-45970-001		PSD	001
REVISION		T6	
MATERIAL NUMBER		CUSTOMER	SHEET NUMBER
SEE CHART		GENERAL MARKET	3 OF 7

RECOMMENDED PCB LAYOUT: COMPONENT SIDE  
 SOLDER SCREEN APERTURE SIZE: .890/.035 DIAMETER  
 PCB THICKNESS: NA

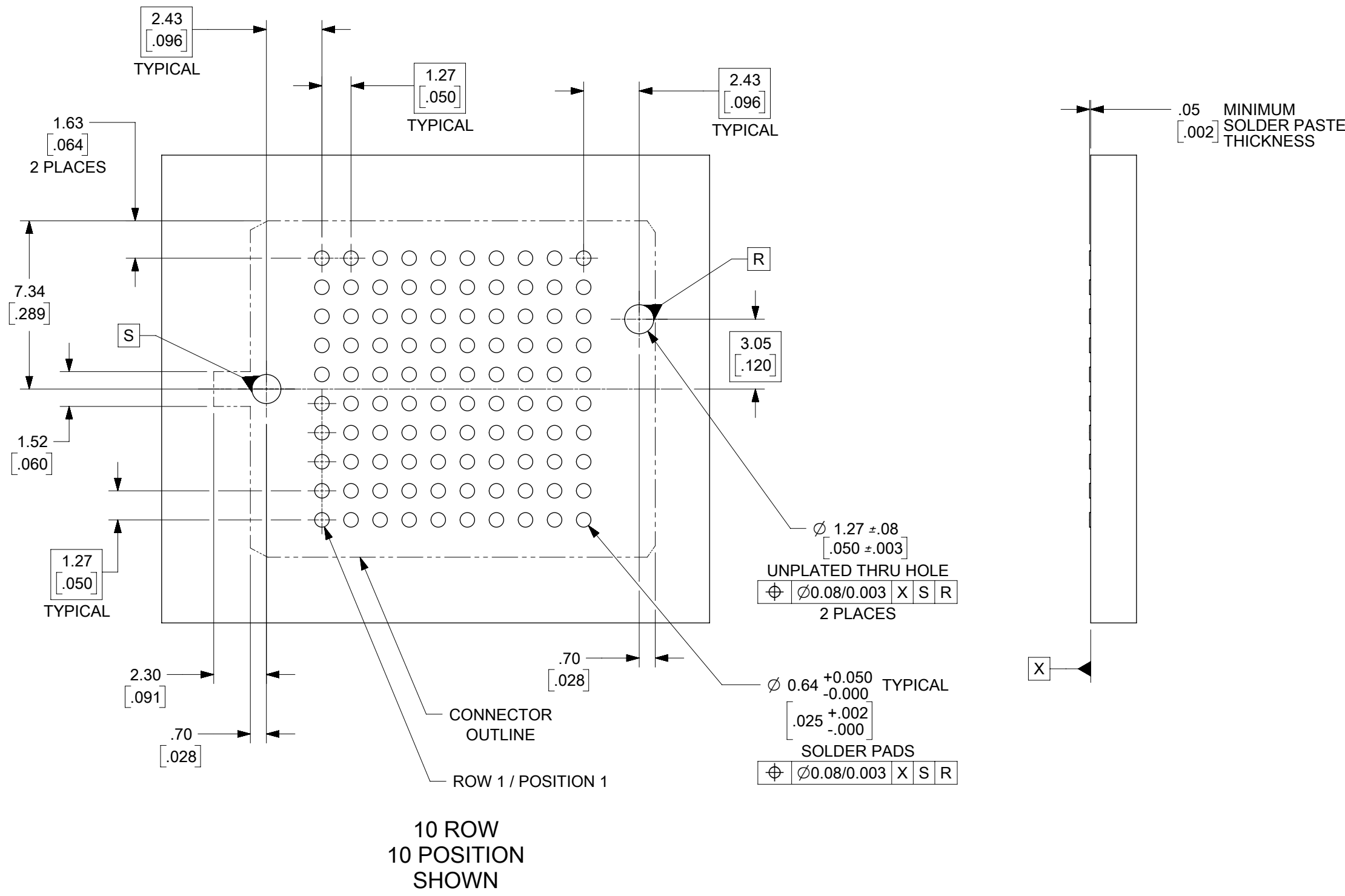

THIS DRAWING CONTAINS INFORMATION THAT IS PROPRIETARY TO MOLEX ELECTRONIC TECHNOLOGIES, LLC AND SHOULD NOT BE USED WITHOUT WRITTEN PERMISSION									
SYMBOLS		DIMENSION UNITS	SCALE	CURRENT REV DESC: SEE REV TABLE SHT 7					
▽ = 0	▽ = 0	mm	5:1	EC NO: 617843 DRWN: PMAHADEVAPPA 2019/05/24 CHK'D: DMCGOWAN 2019/05/24 APPR: DMCGOWAN 2019/05/24 INITIAL REVISION: DRWN: TGREGORI 2006/01/25 APPR: JCOMERCI 2006/01/30					
▽ = 0	▽ = 0	GENERAL TOLERANCES (UNLESS SPECIFIED)							
▽ = 0	▽ = 0	ANGULAR TOL ± °							
▽ = 0	▽ = 0	4 PLACES ±							
▽ = 0	▽ = 0	3 PLACES ±							
▽ = 0	▽ = 0	2 PLACES ± 0.25		PRODUCT CUSTOMER DRAWING					
▽ = 0	▽ = 0	1 PLACE ± 0.38		DOCUMENT NUMBER		DOC TYPE	DOC PART	REVISION	
▽ = 0	▽ = 0	0 PLACES ±		SD-45970-001		PSD	001	T6	
▽ = 0	▽ = 0	DRAFT WHERE APPLICABLE MUST REMAIN WITHIN DIMENSIONS		THIRD ANGLE PROJECTION	DRAWING	SERIES	MATERIAL NUMBER	CUSTOMER	SHEET NUMBER
▽ = 0	▽ = 0				B-SIZE	45970	SEE CHART	GENERAL MARKET	4 OF 7

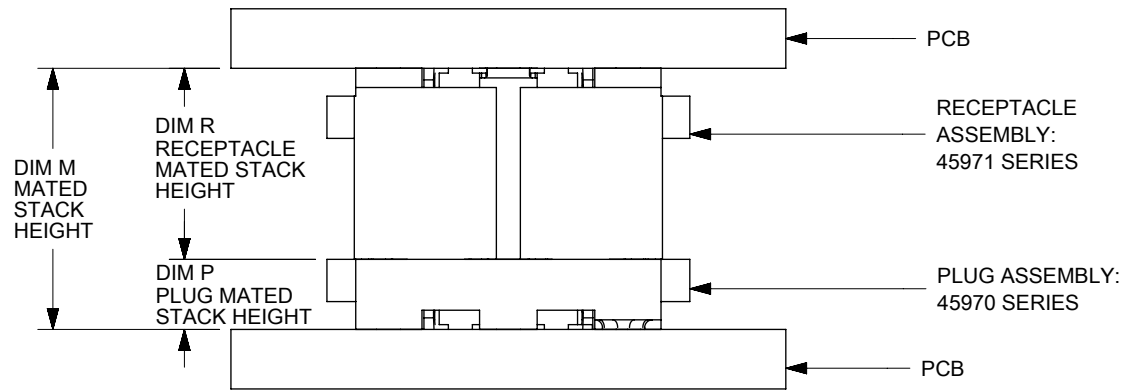

STACK HEIGHTS  
GIVEN IN MILLIMETERS (MM) FOR REFERENCE ONLY

ROWS: 6 DIMENSION C = 9.60/.378

DIM P:	2.0 mm	3.0 mm	3.5 mm	2.5 mm	4.5 mm	5.0 mm	7.0 mm
DIM H:	5.61/.221	6.60/.260	7.11/.280	6.12/.241	8.10/.319	8.61/.339	10.61/.418
DIM S:	5.86/.231	6.85/.270	7.36/.290	6.37/.251	8.35/.329	8.86/.349	10.86/.428
POSITION	DIM G	MATERIAL NO	MATERIAL NO	MATERIAL NO	MATERIAL NO	MATERIAL NO	MATERIAL NO
10	17.69/0.698	45970-1165	45970-1265	45970-1365	45970-1465	45970-1565	45970-1765
20	30.39/1.198	45970-2165	45970-2265	45970-2365	45970-2465	45970-2565	45970-2765
30	43.09/1.698	45970-3165	45970-3265	45970-3365	45970-3465	45970-3565	45970-3765
40	55.79/2.198	45970-4165	45970-4265	45970-4365	45970-4465	45970-4565	45970-4765
50	68.49/2.698	45970-5165	45970-5265	45970-5365	45970-5465	45970-5565	45970-5765
15	24.04/0.948	45970-6165	45970-6265	45970-6365	45970-6465	45970-6565	45970-6765
25	36.74/1.448	45970-7165	45970-7265	45970-7365	45970-7465	45970-7565	45970-7765
35	49.44/1.948	45970-8165	45970-8265	45970-8365	45970-8465	45970-8565	45970-8765
45	62.14/2.448	45970-9165	45970-9265	45970-9365	45970-9465	45970-9565	45970-9765

MATING STACK HEIGHTS (DIMENSION P)  
GIVEN IN MILLIMETERS (mm) FOR REFERENCE ONLY

		DIM R RECEPTACLE STACK HEIGHT									
		5.0		6.0		6.5		7.5		8.0	
mm	DIM P FULLY MATED	DIM M MAX	DIM M FULLY MATED	DIM M MAX	DIM M FULLY MATED	DIM M MAX	DIM M FULLY MATED	DIM M MAX	DIM M FULLY MATED	DIM M MAX	DIM M FULLY MATED
		DIM P PLUG STACK HEIGHT	2.0	7.00	7.74	8.00	8.74	8.50	9.24	9.50	10.24
2.5	7.50		8.24	8.50	9.24	9.00	9.74	10.00	10.74	10.50	11.24
3.0	8.00		8.74	9.00	9.74	9.50	10.24	10.50	11.24	11.00	11.74
3.5	8.50		9.24	9.50	10.24	10.00	10.74	11.00	11.74	11.50	12.24
4.5	9.50		10.24	10.50	11.24	11.00	11.74	12.00	12.74	12.50	13.24
5.0	10.00		10.74	11.00	11.74	11.50	12.24	12.50	13.24	13.00	13.74
7.0	12.00		12.74	13.00	13.74	13.50	14.24	14.50	15.24	15.00	15.74
9.0	14.00		14.74	15.00	15.74	15.50	16.24	16.50	17.24	17.00	17.74

MATED STACK HEIGHTS  
GIVEN IN MILLIMETERS (mm) FOR REFERENCE ONLY

SYMBOLS	THIS DRAWING CONTAINS INFORMATION THAT IS PROPRIETARY TO MOLEX ELECTRONIC TECHNOLOGIES, LLC AND SHOULD NOT BE USED WITHOUT WRITTEN PERMISSION										
	DIMENSION UNITS		SCALE		CURRENT REV DESC: SEE REV TABLE SHT 7						
	mm		1:1		<b>molex</b> SEARAY PLUG ASSEMBLY 1.27/.050 CENTERS PRODUCT CUSTOMER DRAWING						
	GENERAL TOLERANCES (UNLESS SPECIFIED)										
	ANGULAR TOL ± °				EC NO: 617843 DRWN: PMAHADEVAPPA 2019/05/24 CHK'D: DMCGOWAN 2019/05/24 APPR: DMCGOWAN 2019/05/24						
	4 PLACES ±				INITIAL REVISION: DRWN: TGREGORI 2006/01/25 APPR: JCOMERCI 2006/01/30						
	3 PLACES ±										
	2 PLACES ± 0.25				DOCUMENT NUMBER		DOC TYPE	DOC PART	REVISION		
	1 PLACE ± 0.38				SD-45970-001		PSD	001	T6		
	0 PLACES ±				MATERIAL NUMBER		CUSTOMER		SHEET NUMBER		
DRAFT WHERE APPLICABLE MUST REMAIN WITHIN DIMENSIONS		THIRD ANGLE PROJECTION		DRAWING		SERIES		SEE CHART		GENERAL MARKET	5 OF 7

ROWS: 8 DIMENSION C = 12.14/.478								
DIM P:		2.0 mm	3.0 mm	3.5 mm	2.5 mm	4.5 mm	5.0 mm	7.0 mm
DIM H:		5.61/.221	6.60/.260	7.11/.280	6.12/.241	8.10/.319	8.61/.339	10.61/.418
DIM S:		5.86/.231	6.85/.270	7.36/.290	6.37/.251	8.35/.329	8.86/.349	10.86/.428
POSITION	DIM G	MATERIAL NO	MATERIAL NO	MATERIAL NO	MATERIAL NO	MATERIAL NO	MATERIAL NO	MATERIAL NO
10	17.69/0.698	45970-1185	45970-1285	45970-1385	45970-1485	45970-1585	45970-1685	45970-1785
20	30.39/1.198	45970-2185	45970-2285	45970-2385	45970-2485	45970-2585	45970-2685	45970-2785
30	43.09/1.698	45970-3185	45970-3285	45970-3385	45970-3485	45970-3585	45970-3685	45970-3785
40	55.79/2.198	45970-4185	45970-4285	45970-4385	45970-4485	45970-4585	45970-4685	45970-4785
50	68.49/2.698	45970-5185	45970-5285	45970-5385	45970-5485	45970-5585	45970-5685	45970-5785
15	24.04/0.948	45970-6185	45970-6285	45970-6385	45970-6485	45970-6585	45970-6685	45970-6785
25	36.74/1.448	45970-7185	45970-7285	45970-7385	45970-7485	45970-7585	45970-7685	45970-7785
35	49.44/1.948	45970-8185	45970-8285	45970-8385	45970-8485	45970-8585	45970-8685	45970-8785
45	62.14/2.448	45970-9185	45970-9285	45970-9385	45970-9485	45970-9585	45970-9685	45970-9785

ROWS: 10 DIMENSION C = 14.68/.578										
DIM P:		2.0 mm	3.0 mm	3.5 mm	2.5 mm	4.5 mm	5.0 mm	7.0 mm	9.0 mm	9.0 mm
DIM H:		5.61/.221	6.60/.260	7.11/.280	6.12/.241	8.10/.319	8.61/.339	10.61/.418	12.62/.497	12.62/.497
DIM S:		5.86/.231	6.85/.270	7.36/.290	6.37/.251	8.35/.329	8.86/.349	10.86/.428	12.87/.507	12.87/.507
POSITION	DIM G	MATERIAL NO	MATERIAL NO	MATERIAL NO	MATERIAL NO	MATERIAL NO	MATERIAL NO	MATERIAL NO	MATERIAL NO	MATERIAL NO
10	17.69/0.698	45970-1115	45970-1215	45970-1315	45970-1415	45970-1515	45970-1615	45970-1715	45970-1915	
20	30.39/1.198	45970-2115	45970-2215	45970-2315	45970-2415	45970-2515	45970-2615	45970-2715	45970-2915	
30	43.09/1.698	45970-3115	45970-3215	45970-3315	45970-3415	45970-3515	45970-3615	45970-3715	45970-3915	
40	55.79/2.198	45970-4115	45970-4215	45970-4315	45970-4415	45970-4515	45970-4615	45970-4715	45970-4915	45970-4916
50	68.49/2.698	45970-5115	45970-5215	45970-5315	45970-5415	45970-5515	45970-5615	45970-5715	45970-5915	45970-5916
15	24.04/0.948	45970-6115	45970-6215	45970-6315	45970-6415	45970-6515	45970-6615	45970-6715	45970-6915	
25	36.74/1.448	45970-7115	45970-7215	45970-7315	45970-7415	45970-7515	45970-7615	45970-7715	45970-7915	
35	49.44/1.948	45970-8115	45970-8215	45970-8315	45970-8415	45970-8515	45970-8615	45970-8715	45970-8915	
45	62.14/2.448	45970-9115	45970-9215	45970-9315	45970-9415	45970-9515	45970-9615	45970-9715	45970-9915	

MATING STACK HEIGHTS (DIMENSION P)  
GIVEN IN MILLIMETERS (mm) FOR REFERENCE ONLY

9.0mm PLUG WITH ALIGNER  
45970-4916 SHOWN

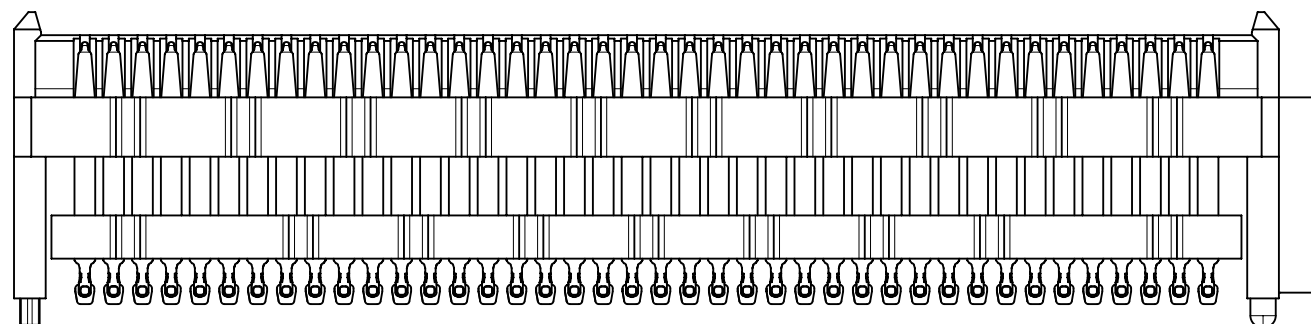

THIS DRAWING CONTAINS INFORMATION THAT IS PROPRIETARY TO MOLEX ELECTRONIC TECHNOLOGIES, LLC AND SHOULD NOT BE USED WITHOUT WRITTEN PERMISSION										
SYMBOLS		DIMENSION UNITS		SCALE		CURRENT REV DESC: SEE REV TABLE SHT 7				
▽ = 0		mm		3:1		<b>molex</b> SEARAY PLUG ASSEMBLY 1.27/.050 CENTERS PRODUCT CUSTOMER DRAWING				
▽ = 0		GENERAL TOLERANCES (UNLESS SPECIFIED)								
▽ = 0		ANGULAR TOL ± °				EC NO: 617843 DRWN: PMAHADEVAPPA 2019/05/24 CHK'D: DMCGOWAN 2019/05/24 APPR: DMCGOWAN 2019/05/24				
▽ = 0		4 PLACES ±				INITIAL REVISION: DRWN: TGREGORI 2006/01/25 APPR: JCOMERCI 2006/01/30				
▽ = 0		3 PLACES ±								
▽ = 0		2 PLACES ± 0.25				DOCUMENT NUMBER <b>SD-45970-001</b> DOC TYPE DOC PART REVISION PSD 001 T6				
▽ = 0		1 PLACE ± 0.38								
▽ = 0		0 PLACES ±				MATERIAL NUMBER CUSTOMER SHEET NUMBER SEE CHART GENERAL MARKET 6 OF 7				
▽ = 0		DRAFT WHERE APPLICABLE MUST REMAIN WITHIN DIMENSIONS								
▽ = 0		THIRD ANGLE PROJECTION		DRAWING		SERIES				
		B-SIZE		45970						



F  
E  
D  
C  
B  
A

REV	DATE	DESCRIPTION
T3	2017/03/28	MIGRATED TO ECTR / NX
	2017/06/09	ADDED RECOMMENDED PCB LAYOUT FOR 8 ROW ASSEMBLIES ON SHEET 3, UPDATED VIEWS SHEET 1, SHIFTED TABLES TO NEXT SHEETS.
T4	2018/10/03	ADD PAD LOCATION DIMENSIONS ON SHEET 2, UPDATE MATING HEIGHT TABLE ON SHEET 5, ADD VERSIONS WITH ALIGNERS ON SHEET 6
T5	2019/01/15	UPDATE 8 ROW CHART ON SHEET 6
T6	2019/05/20	ADDED RECOMMENDED PCB LAYOUT FOR 10 ROW ASSEMBLIES ON SHEET 4, SHIFTED TABLES TO NEXT SHEETS.

SYMBOLS	THIS DRAWING CONTAINS INFORMATION THAT IS PROPRIETARY TO MOLEX ELECTRONIC TECHNOLOGIES, LLC AND SHOULD NOT BE USED WITHOUT WRITTEN PERMISSION														
	DIMENSION UNITS		SCALE		CURRENT REV DESC: SEE REV TABLE SHT 7										
	mm		1:1												
	GENERAL TOLERANCES (UNLESS SPECIFIED)		EC NO: 617843								SEARAY PLUG ASSEMBLY 1.27/.050 CENTERS PRODUCT CUSTOMER DRAWING				
	ANGULAR TOL ± °		4 PLACES ±		DRWN: PMAHADEVAPPA 2019/05/24		2019/05/24		DOCUMENT NUMBER				DOC TYPE	DOC PART	REVISION
	3 PLACES ±		2 PLACES ± 0.25		CHK'D: DMCGOWAN 2019/05/24		2019/05/24		SD-45970-001				PSD	001	T6
	2 PLACES ±		1 PLACE ± 0.38		INITIAL REVISION:		DRWN: TGREGORI 2006/01/25		MATERIAL NUMBER		CUSTOMER		SHEET NUMBER		
	1 PLACE ±		0 PLACES ±		APPR: JCOMERCI 2006/01/30		DRAFT WHERE APPLICABLE MUST REMAIN WITHIN DIMENSIONS		SEE CHART		GENERAL MARKET		7 OF 7		
	0 PLACES ±		THIRD ANGLE PROJECTION		DRAWING		SERIES		B-SIZE		45970				
	DRAFT WHERE APPLICABLE MUST REMAIN WITHIN DIMENSIONS		THIRD ANGLE PROJECTION		DRAWING		SERIES		B-SIZE		45970				