

10 9 8 7 6 5 4 3 2 1

CKT SIZE	MATERIAL NUMBER	DIM. A REF	DIM B	DIM P
4	45984-4911	24.60	12.00	4.50
6	45984-6911	36.60	24.00	
8	45984-8911	48.60	36.00	
10	45984-1911	60.60	48.00	
4	45984-4921	24.60	12.00	3.60
6	45984-6921	36.60	24.00	
8	45984-8921	48.60	36.00	
10	45984-1921	60.60	48.00	2.90
4	45984-4931	24.60	12.00	
6	45984-6931	36.60	24.00	
8	45984-8931	48.60	36.00	
10	45984-1931	60.60	48.00	

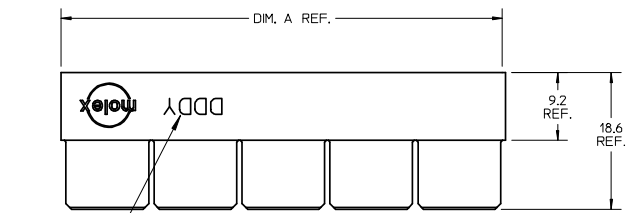

SEE NOTE 10

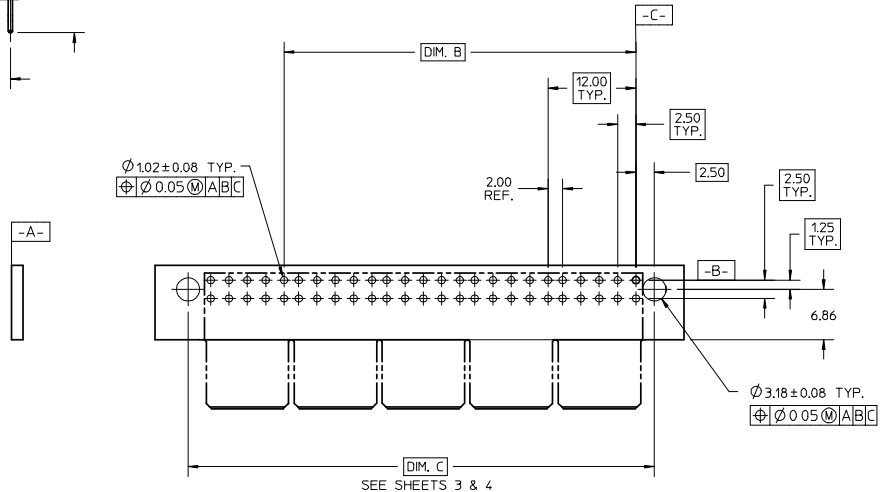
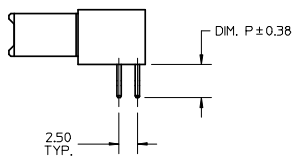
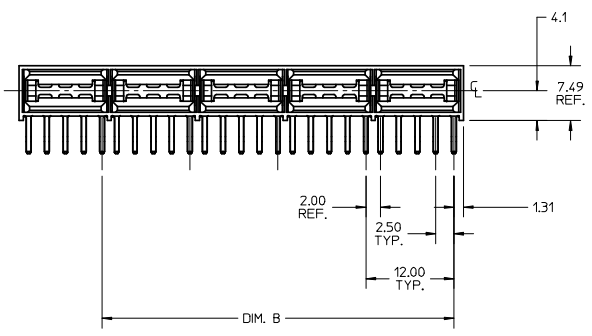

PCB LAYOUT: COMPONENT SIDE
(PEG HOLES OPTIONAL)

- NOTES:
1. MATERIAL - HOUSING: LCP, 94V-0, BLACK
MATERIAL - POWER CONTACT: COPPER ALLOY
 2. FINISH: SELECT GOLD (WITH EB-1: 0.76 μM/30 MI MIN. IN CONTACT AREA
SELECT TIN: 3.81 μM/150 MI MIN. IN PC TAIL AREA
BOTH OVER NICKEL: 1.27 μM/50 MI MIN. PER ES-88-229.
TERMINALS ARE LUBRICATED WITH EB-1 LUBRICANT.
 3. PRODUCT SPECIFICATION: PS-45984-001
 4. PACKAGING SPECIFICATION: TRAY PER PK-45984-001
 5. SEE SHEET 5 FOR CKT IDENTIFICATION
 6. PARTS ARE RoHS COMPLIANT.
 7. PEG HOLES ARE OPTIONAL. SEE SHEET 3 & 4.
 8. MATES TO .1571,062 CARD EDGE OR MOLEX SERIES 45985.
 9. PARTS CONFORM TO CLASS B REQUIREMENTS OF COSMETIC SPECIFICATION PS-45499-002.
 10. DATE CODE (3-DIGIT DAY, 1-DIGIT YEAR) TO BE PRINTED AND LOCATED AS SHOWN.

RELEASED EC NO: UCP2007-3140 DRW: BANDURA 2008/03/03 CHKD: 2008/03/04 APPR: APATEL 2008/03/06	DESCRIPTION LPH RECEPTACLE ASSEMBLY RIGHT ANGLE POWER CONNECTOR	QUALITY SYMBOLS	GENERAL TOLERANCES (UNLESS SPECIFIED)	DIMENSION STYLE	SCALE	DESIGN UNITS	THIRD ANGLE PROJECTION	
		$\nabla=0$ $\sphericalangle=0$	mm INCH	MM ONLY	1:1	METRIC		
		4 PLACES ± --- ± --- 3 PLACES ± --- ± --- 2 PLACES ± 0.25 ± --- 1 PLACE ± --- ± ---	DRAWN BY DATE	DRAWN BY DATE	TITLE	LPH RECEPTACLE ASSEMBLY RIGHT ANGLE POWER CONNECTOR		
		ANGULAR ± 1/2°	CHECKED BY DATE	CHECKED BY DATE	Molex MOLEX INCORPORATED	DOCUMENT NO.	SHEET NO.	
DRAFT WHERE APPLICABLE MUST REMAIN WITHIN DIMENSIONS	MATERIAL NO. SEE CHART	APPROVED BY DATE PATEL	THIS DRAWING CONTAINS INFORMATION THAT IS PROPRIETARY TO MOLEX INCORPORATED AND SHOULD NOT BE USED WITHOUT WRITTEN PERMISSION	SD-45984-102	1 OF 5			

9 8 7 6 5 4 3 2 1

10 9 8 7 6 5 4 3 2 1

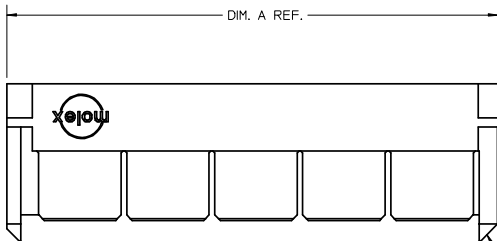

OPTIONAL GUIDES

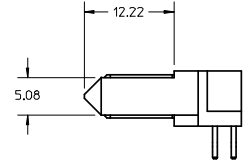
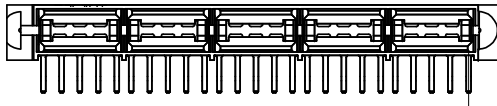

CKT SIZE	MATERIAL NUMBER	DIM. A REF	DIM B	DIM P
4	45984-4912	31.01	12.00	4.50
6	45984-6912	43.01	24.00	
8	45984-8912	55.01	36.00	
10	45984-1912	67.01	48.00	3.60
4	45984-4922	31.01	12.00	
6	45984-6922	43.01	24.00	
8	45984-8922	55.01	36.00	2.90
10	45984-1922	67.01	48.00	
4	45984-4932	31.01	12.00	
6	45984-6932	43.01	24.00	
8	45984-8932	55.01	36.00	
10	45984-1932	67.01	48.00	

RELEASED EC NO: UCP2007-3140 DRWN: BANDURA 2008/03/03 CHKD: 2008/03/04 APPR: APATEL 2008/03/06	QUALITY SYMBOLS ▽=0 ▽7=0	GENERAL TOLERANCES (UNLESS SPECIFIED) <table border="1"> <thead> <tr> <th></th> <th>mm</th> <th>INCH</th> </tr> </thead> <tbody> <tr> <td>4 PLACES</td> <td>±---</td> <td>±---</td> </tr> <tr> <td>3 PLACES</td> <td>±---</td> <td>±---</td> </tr> <tr> <td>2 PLACES</td> <td>±0.25</td> <td>±---</td> </tr> <tr> <td>1 PLACE</td> <td>±---</td> <td>±---</td> </tr> </tbody> </table>		mm	INCH	4 PLACES	±---	±---	3 PLACES	±---	±---	2 PLACES	±0.25	±---	1 PLACE	±---	±---	DIMENSION STYLE MM ONLY	SCALE 1:1	DESIGN UNITS METRIC	THIRD ANGLE PROJECTION
		mm	INCH																		
	4 PLACES	±---	±---																		
	3 PLACES	±---	±---																		
2 PLACES	±0.25	±---																			
1 PLACE	±---	±---																			
DESCRIPTION REV B	DRAFT WHERE APPLICABLE MUST REMAIN WITHIN DIMENSIONS	DRAWN BY BANDURA	DATE 5/16/2006	TITLE LPH RECEPTACLE ASSEMBLY RIGHT ANGLE POWER CONNECTOR																	
		CHECKED BY BANDURA	DATE 5/16/2006	MOLEX INCORPORATED																	
		APPROVED BY PATEL	DATE	MATERIAL NO. SEE CHART	DOCUMENT NO. SD-45984-102	SHEET NO. 2 OF 5															

9 8 7 6 5 4 3 2 1

10 9 8 7 6 5 4 3 2 1

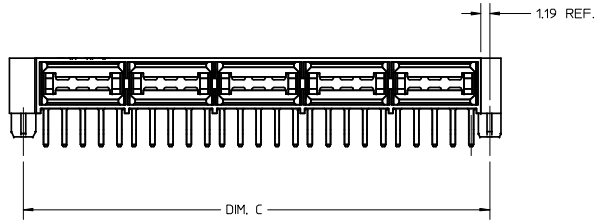
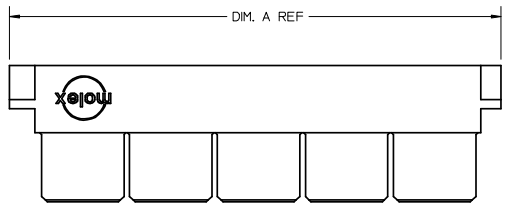

CKT SIZE	MATERIAL NUMBER	DIM. A REF	DIM B	DIM C	DIM P
4	45984-4913	31.01	12.00	27.60	4.50
6	45984-6913	43.01	24.00	39.60	
8	45984-8913	55.01	36.00	51.60	
10	45984-1913	67.01	48.00	63.60	3.60
4	45984-4923	31.01	12.00	27.60	
6	45984-6923	43.01	24.00	39.60	
8	45984-8923	55.01	36.00	51.60	2.90
10	45984-1923	67.01	48.00	63.60	
4	45984-4933	31.01	12.00	27.60	
6	45984-6933	43.01	24.00	39.60	
8	45984-8933	55.01	36.00	51.60	
10	45984-1933	67.01	48.00	63.60	

RELEASED EC NO: UCP2007-3140 DRAWN: BANDURA 2008/03/03 CHKD: 2008/03/04 APPR: APATEL 2008/03/06	DESCRIPTION REV	QUALITY SYMBOLS	GENERAL TOLERANCES (UNLESS SPECIFIED)	DIMENSION STYLE	SCALE	DESIGN UNITS	THIRD ANGLE PROJECTION	
		$\nabla=0$ $\nabla=0$	mm INCH 4 PLACES ± --- ± --- 3 PLACES ± --- ± --- 2 PLACES ± 0.25 ± --- 1 PLACE ± --- ± --- ANGULAR ± 1/2°	MM ONLY	1:1	METRIC	BANDURA 5/16/2006 BANDURA 5/16/2006 PATEL	TITLE LPH RECEPTACLE ASSEMBLY RIGHT ANGLE POWER CONNECTOR
		DRAFT WHERE APPLICABLE MUST REMAIN WITHIN DIMENSIONS		MATERIAL NO.	DOCUMENT NO.	SHEET NO.		
		SEE CHART		SD-45984-102	3 OF 5			

THIS DRAWING CONTAINS INFORMATION THAT IS PROPRIETARY TO MOLEX INCORPORATED AND SHOULD NOT BE USED WITHOUT WRITTEN PERMISSION

9 8 7 6 5 4 3 2 1

10 9 8 7 6 5 4 3 2 1

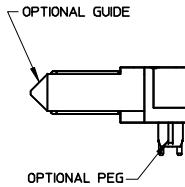
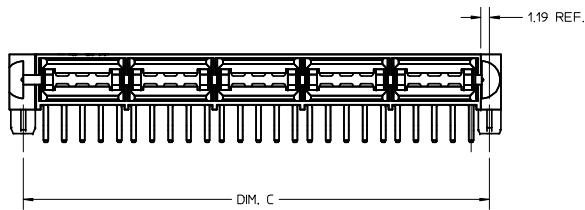
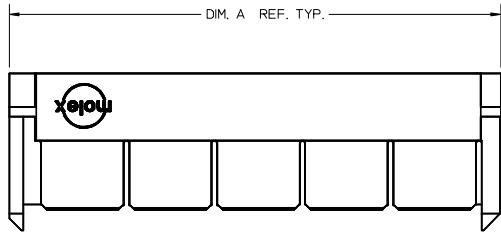

CKT SIZE	MATERIAL NUMBER	DIM. A REF	DIM B	DIM C	DIM P
4	45984-4914	31.01	12.00	27.60	4.50
6	45984-6914	43.01	24.00	39.60	
8	45984-8914	55.01	36.00	51.60	
10	45984-1914	67.01	48.00	63.60	3.60
4	45984-4924	31.01	12.00	27.60	
6	45984-6924	43.01	24.00	39.60	
8	45984-8924	55.01	36.00	51.60	2.90
10	45984-1924	67.01	48.00	63.60	
4	45984-4934	31.01	12.00	27.60	
6	45984-6934	43.01	24.00	39.60	
8	45984-8934	55.01	36.00	51.60	
10	45984-1934	67.01	48.00	63.60	

RELEASED EC NO: UCP2007-3140 DRAWN: BANDURA 2008/03/03 CHKD: 2008/03/04 APPR: APATEL 2008/03/06	REV DESCRIPTION B	QUALITY SYMBOLS	GENERAL TOLERANCES (UNLESS SPECIFIED)	DIMENSION STYLE	SCALE	DESIGN UNITS	THIRD ANGLE PROJECTION
		$\nabla=0$ $\nabla=0$	mm INCH	MM ONLY	1:1	METRIC	THIRD ANGLE RIGHT ANGLE PROJECTION
		4 PLACES ± --- ± --- 3 PLACES ± --- ± --- 2 PLACES ± 0.25 ± --- 1 PLACE ± --- ± ---	DRAWN BY DATE BANDURA 5/16/2006 CHECKED BY DATE BANDURA 5/16/2006 APPROVED BY DATE PATEL	TITLE	LPH RECEPTACLE ASSEMBLY RIGHT ANGLE POWER CONNECTOR		
		ANGULAR ± 1/2° DRAFT WHERE APPLICABLE MUST REMAIN WITHIN DIMENSIONS	MATERIAL NO. SEE CHART SIZE B	MOLEX INCORPORATED DOCUMENT NO. SD-45984-102	SHEET NO. 4 OF 5		

9 8 7 6 5 4 3 2 1

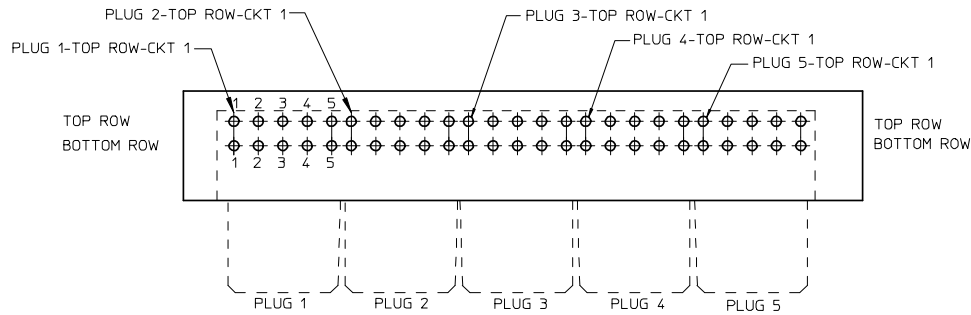
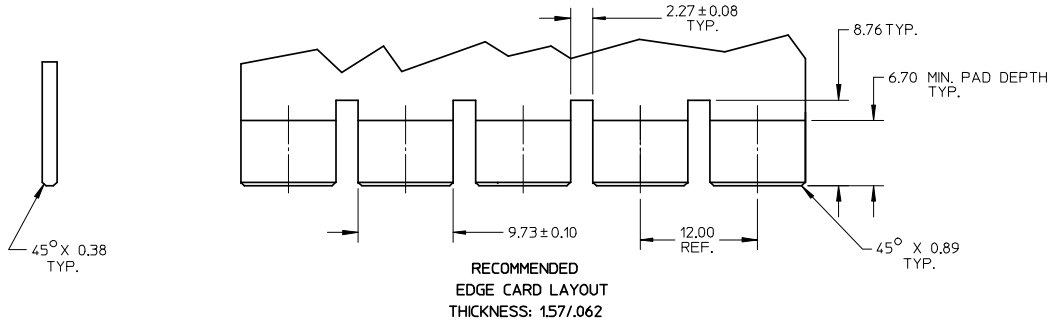
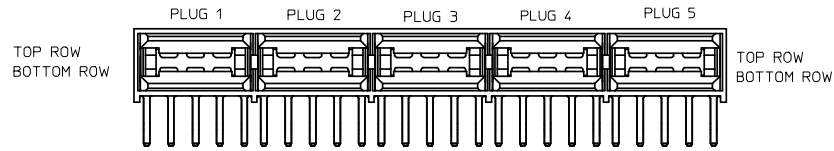

PCB LAYOUT: COMPONENT SIDE
SEE SHEET 1 FOR DIMENSIONS

RELEASED EC NO: UCP2007-3140 DRWN: BANDURA 2008/03/03 CHKD: 2008/03/04 APPR: APATEL 2008/03/06	DESCRIPTION REV B	QUALITY SYMBOLS	GENERAL TOLERANCES (UNLESS SPECIFIED)	DIMENSION STYLE MM ONLY		SCALE 1:1	DESIGN UNITS METRIC	THIRD ANGLE PROJECTION		
		▽=0 ▽7=0	mm INCH 4 PLACES ± --- ± --- 3 PLACES ± --- ± --- 2 PLACES ± 0.25 ± --- 1 PLACE ± --- ± ---	DRAWN BY BANDURA	DATE 5/16/2006	TITLE LPH RECEPTACLE ASSEMBLY RIGHT ANGLE POWER CONNECTOR				
		ANGULAR ±1/2°		CHECKED BY BANDURA	DATE 5/16/2006					
		DRAFT WHERE APPLICABLE MUST REMAIN WITHIN DIMENSIONS		MATERIAL NO. SEE CHART		MOLEX INCORPORATED			DOCUMENT NO. SD-45984-102	SHEET NO. 5 OF 5
THIS DRAWING CONTAINS INFORMATION THAT IS PROPRIETARY TO MOLEX INCORPORATED AND SHOULD NOT BE USED WITHOUT WRITTEN PERMISSION										