

- NOTES:
1. MATERIAL:
HOUSING: GLASS FILLED LCP (LIQUID CRYSTAL POLYMER), UL94V-0, COLOR: BLACK.
POWER CONTACT: COPPER ALLOY
SIGNAL CONTACT: PHOSPHOR BRONZE
 2. FINISH: SELECT GOLD 0.76 MICROMETER/30 MICROINCH MINIMUM.
SELECT TIN 3.81 MICROMETER/150 MICROINCH MINIMUM.
BOTH OVER NICKEL 1.27MICROMETER/50 MICROINCH MINIMUM.
 3. PRODUCT SPECIFICATION: PS-45984-001
 4. PACKAGING SPECIFICATION: TRAY PER PK-45984-001
SEE SHEET 5 FOR CIRCUIT IDENTIFICATION.
 6. PARTS ARE RoHS COMPLIANT.
 7. PEG HOLES ARE OPTIONAL PCB FEATURES AND ARE REQUIRED ONLY WITH THE PEGGED HOUSING OPTIONS.
 8. MATES WITH MOLEX RECEPTACLE SERIES 45984-1***.
 9. DIM. P TO BE MEASURED FROM THE HOUSING STAND-OFF TO THE TERMINAL TIP.

| NO OF SIGNAL | MATERIAL NUMBER | DIM A REF | DIM P | PCB THK |
|--------------|-----------------|-----------|-------|---------|
| 12 | 45985-1111 | 72.16 | 4.50 | 3.18 |
| 16 | 45985-1121 | 74.70 | | |
| 20 | 45985-1131 | 77.24 | | |
| 24 | 45985-1141 | 79.78 | | |
| 28 | 45985-1151 | 82.32 | | |
| 32 | 45985-1161 | 84.86 | 3.90 | 2.36 |
| 36 | 45985-1171 | 87.40 | | |
| 40 | 45985-1181 | 89.94 | | |
| 12 | 45985-1112 | 72.16 | | |
| 16 | 45985-1122 | 74.70 | | |
| 20 | 45985-1132 | 77.24 | 2.90 | 1.57 |
| 24 | 45985-1142 | 79.78 | | |
| 28 | 45985-1152 | 82.32 | | |
| 32 | 45985-1162 | 84.86 | | |
| 36 | 45985-1172 | 87.40 | | |
| 40 | 45985-1182 | 89.94 | 2.90 | 1.57 |
| 12 | 45985-1113 | 72.16 | | |
| 16 | 45985-1123 | 74.70 | | |
| 20 | 45985-1133 | 77.24 | | |
| 24 | 45985-1143 | 79.78 | | |
| 28 | 45985-1153 | 82.32 | | |
| 32 | 45985-1163 | 84.86 | | |
| 36 | 45985-1173 | 87.40 | | |
| 40 | 45985-1183 | 89.94 | | |

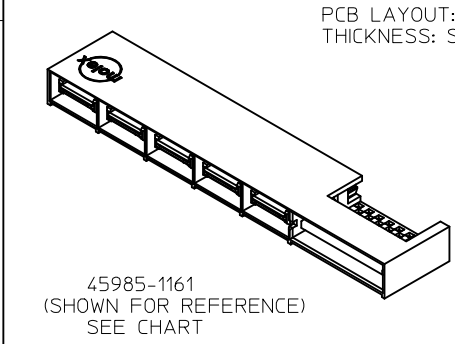
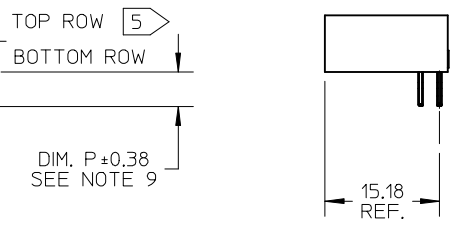

ADD NOTE 9
 EC NO: UCP2016-3486
 DRWN:MBANDURA 2016/06/13
 CHKD:
 APPR:BP/SLZOR 2016/07/26
 DESCRIPTION
 REV
 D2

GENERAL TOLERANCES (UNLESS SPECIFIED)

| | mm | INCH |
|----------|--------|-------|
| 4 PLACES | ± --- | ± --- |
| 3 PLACES | ± --- | ± --- |
| 2 PLACES | ± 0.25 | ± --- |
| 1 PLACE | ± --- | ± --- |

ANGULAR ±1/2°

DRAFT WHERE APPLICABLE
 MUST REMAIN
 WITHIN DIMENSIONS

DIMENSION STYLE
MM ONLY

DRAWN BY DATE
 SCHAFFER 2005/06/20

CHECKED BY DATE
 SAMIEC 2005/06/21

APPROVED BY DATE
 MARGULIS 2005/06/22

MATERIAL NO.
 SEE CHARTS

SIZE
 A

SCALE
1:1

DESIGN UNITS
METRIC

THIRD ANGLE PROJECTION

TITLE
**LPH PLUG ASSEMBLY
 RT ANGLE 10 CIRCUIT
 POWER CONNECTOR**

MOLEX INCORPORATED

DOCUMENT NO.
SD-45985-100

SHEET NO.
1 OF 5

THIS DRAWING CONTAINS INFORMATION THAT IS PROPRIETARY TO MOLEX INCORPORATED AND SHOULD NOT BE USED WITHOUT WRITTEN PERMISSION

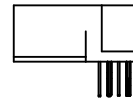
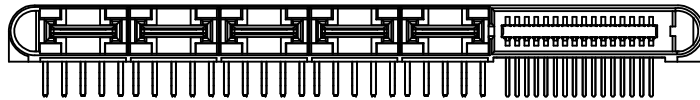
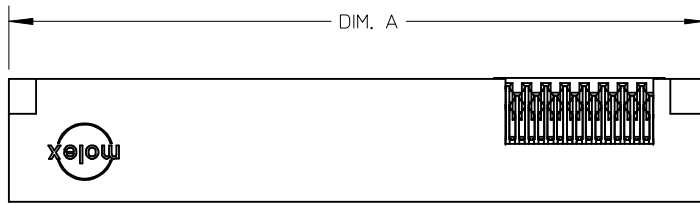

GUIDE OPTIONS

| NO OF SIGNAL | MATERIAL NUMBER | DIM A REF | DIM P | PCB THK |
|--------------|-----------------|-----------|-------|---------|
| 12 | 45985-1211 | 79.66 | 4.50 | 3.18 |
| 16 | 45985-1221 | 82.20 | | |
| 20 | 45985-1231 | 84.74 | | |
| 24 | 45985-1241 | 87.28 | | |
| 28 | 45985-1251 | 89.82 | | |
| 32 | 45985-1261 | 92.36 | | |
| 36 | 45985-1271 | 94.90 | | |
| 40 | 45985-1281 | 97.44 | | |
| 12 | 45985-1212 | 79.66 | 3.90 | 2.36 |
| 16 | 45985-1222 | 82.20 | | |
| 20 | 45985-1232 | 84.74 | | |
| 24 | 45985-1242 | 87.28 | | |
| 28 | 45985-1252 | 89.82 | | |
| 32 | 45985-1262 | 92.36 | | |
| 36 | 45985-1272 | 94.90 | | |
| 40 | 45985-1282 | 97.44 | | |
| 12 | 45985-1213 | 79.66 | 2.90 | 1.57 |
| 16 | 45985-1223 | 82.20 | | |
| 20 | 45985-1233 | 84.74 | | |
| 24 | 45985-1243 | 87.28 | | |
| 28 | 45985-1253 | 89.82 | | |
| 32 | 45985-1263 | 92.36 | | |
| 36 | 45985-1273 | 94.90 | | |
| 40 | 45985-1283 | 97.44 | | |

NOTE:
1. SEE SHEET 1 FOR DIMENSIONS NOT SHOWN.

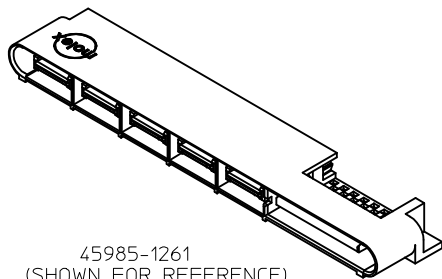

45985-1261
(SHOWN FOR REFERENCE)
SEE CHART

| | |
|----------------------------|-------------|
| SEE SHEET 1 | DESCRIPTION |
| EC NO: UCP2016-3486 | |
| DRWN:MBANDURA 2016/06/13 | |
| CHKD: | |
| APPR:BP ISZCZOR 2016/07/26 | |
| D2 | REV |

| | | |
|--|--------|-------|
| GENERAL TOLERANCES (UNLESS SPECIFIED) | | |
| | mm | INCH |
| 4 PLACES | ± --- | ± --- |
| 3 PLACES | ± --- | ± --- |
| 2 PLACES | ± 0.25 | ± --- |
| 1 PLACE | ± --- | ± --- |
| ANGULAR ±1/2° | | |
| DRAFT WHERE APPLICABLE MUST REMAIN WITHIN DIMENSIONS | | |

| | |
|-----------------|------------|
| DIMENSION STYLE | |
| MM ONLY | |
| DRAWN BY | DATE |
| SCHAFFER | 2005/06/20 |
| CHECKED BY | DATE |
| SAMIEC | 2005/06/21 |
| APPROVED BY | DATE |
| MARGULIS | 2005/06/22 |
| MATERIAL NO. | |
| SEE CHART | |
| SIZE | |
| A | |

| | | | |
|---|--------------|------------------------|-----------|
| SCALE | DESIGN UNITS | THIRD ANGLE PROJECTION | |
| 1:1 | METRIC | | |
| TITLE | | | |
| LPH PLUG ASSEMBLY RT ANGLE 10 CIRCUIT POWER CONNECTOR | | | |
| MOLEX INCORPORATED | | | |
| DOCUMENT NO. | | | SHEET NO. |
| SD-45985-100 | | | 2 OF 5 |
| THIS DRAWING CONTAINS INFORMATION THAT IS PROPRIETARY TO MOLEX INCORPORATED AND SHOULD NOT BE USED WITHOUT WRITTEN PERMISSION | | | |

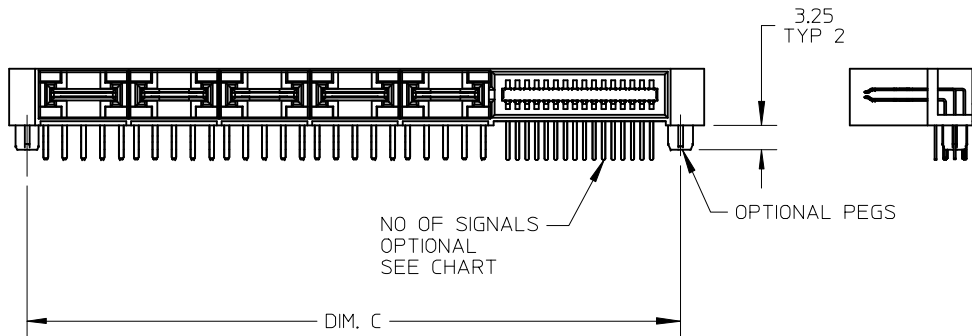
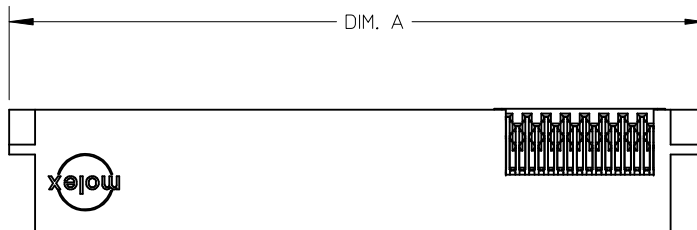

| NO OF SIGNAL | MATERIAL NUMBER | DIM A REF | DIM C | DIM P | PCB THK |
|--------------|-----------------|-----------|-------|-------|---------|
| 12 | 45985-1311 | 79.66 | 73.98 | 4.50 | 3.18 |
| 16 | 45985-1321 | 82.20 | 76.52 | | |
| 20 | 45985-1331 | 84.74 | 79.06 | | |
| 24 | 45985-1341 | 87.28 | 81.60 | | |
| 28 | 45985-1351 | 89.82 | 84.14 | | |
| 32 | 45985-1361 | 92.36 | 86.68 | | |
| 36 | 45985-1371 | 94.90 | 89.22 | 3.90 | 2.36 |
| 40 | 45985-1381 | 97.44 | 91.76 | | |
| 12 | 45985-1312 | 79.66 | 73.98 | | |
| 16 | 45985-1322 | 82.20 | 76.52 | | |
| 20 | 45985-1332 | 84.74 | 79.06 | | |
| 24 | 45985-1342 | 87.28 | 81.60 | | |
| 28 | 45985-1352 | 89.82 | 84.14 | 2.90 | 1.57 |
| 32 | 45985-1362 | 92.36 | 86.68 | | |
| 36 | 45985-1372 | 94.90 | 89.22 | | |
| 40 | 45985-1382 | 97.44 | 91.76 | | |
| 12 | 45985-1313 | 79.66 | 73.98 | | |
| 16 | 45985-1323 | 82.20 | 76.52 | | |
| 20 | 45985-1333 | 84.74 | 79.06 | 2.90 | 1.57 |
| 24 | 45985-1343 | 87.28 | 81.60 | | |
| 28 | 45985-1353 | 89.82 | 84.14 | | |
| 32 | 45985-1363 | 92.36 | 86.68 | | |
| 36 | 45985-1373 | 94.90 | 89.22 | 2.90 | 1.57 |
| 40 | 45985-1383 | 97.44 | 91.76 | | |

MOUNTING PEG OPTIONS

NOTE:
1. SEE SHEET 1 FOR DIMENSIONS NOT SHOWN.

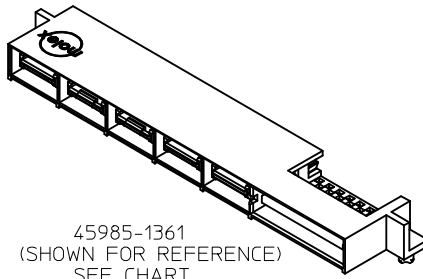

| | |
|-----------------------------|-------------|
| SEE SHEET 1 | DESCRIPTION |
| EC NO: UCP2016-3486 | |
| DRWN:MBANDURA 2016/06/13 | |
| CHKD: | |
| APPR:BP SZCZOR 2016/07/26 | |
| D2 | REV |

| | |
|--|--------------|
| GENERAL TOLERANCES (UNLESS SPECIFIED) | |
| | mm INCH |
| 4 PLACES | ± --- ± --- |
| 3 PLACES | ± --- ± --- |
| 2 PLACES | ± 0.25 ± --- |
| 1 PLACE | ± --- ± --- |
| ANGULAR ±1/2° | |
| DRAFT WHERE APPLICABLE MUST REMAIN WITHIN DIMENSIONS | |

| | |
|-----------------|------------|
| DIMENSION STYLE | |
| MM ONLY | |
| DRAWN BY | DATE |
| SCHAFER | 2005/06/20 |
| CHECKED BY | DATE |
| SAMIEC | 2005/06/21 |
| APPROVED BY | DATE |
| MARGULIS | 2005/06/22 |
| MATERIAL NO. | |
| SEE CHART | |

| | | |
|---|--------------|------------------------|
| SCALE | DESIGN UNITS | THIRD ANGLE PROJECTION |
| 1:1 | METRIC | |
| TITLE | | |
| LPH PLUG ASSEMBLY RT ANGLE 10 CIRCUIT POWER CONNECTOR | | |
| MOLEX INCORPORATED | | |
| MATERIAL NO. | DOCUMENT NO. | SHEET NO. |
| SEE CHART | SD-45985-100 | 3 OF 5 |
| THIS DRAWING CONTAINS INFORMATION THAT IS PROPRIETARY TO MOLEX INCORPORATED AND SHOULD NOT BE USED WITHOUT WRITTEN PERMISSION | | |

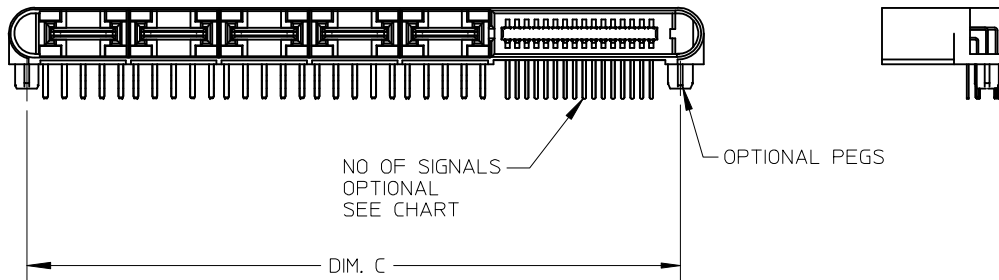
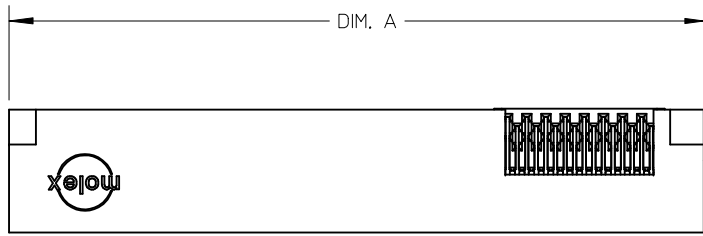

| NO OF SIGNAL | MATERIAL NUMBER | DIM A REF | DIM C | DIM P | PCB THK |
|--------------|-----------------|-----------|-------|-------|---------|
| 12 | 45985-1411 | 79.66 | 73.98 | 4.50 | 3.18 |
| 16 | 45985-1421 | 82.20 | 76.52 | | |
| 20 | 45985-1431 | 84.74 | 79.06 | | |
| 24 | 45985-1441 | 87.28 | 81.60 | | |
| 28 | 45985-1451 | 89.82 | 84.14 | | |
| 32 | 45985-1461 | 92.36 | 86.68 | | |
| 36 | 45985-1471 | 94.90 | 89.22 | 3.90 | 2.36 |
| 40 | 45985-1481 | 97.44 | 91.76 | | |
| 12 | 45985-1412 | 79.66 | 73.98 | | |
| 16 | 45985-1422 | 82.20 | 76.52 | | |
| 20 | 45985-1432 | 84.74 | 79.06 | | |
| 24 | 45985-1442 | 87.28 | 81.60 | | |
| 28 | 45985-1452 | 89.82 | 84.14 | | |
| 32 | 45985-1462 | 92.36 | 86.68 | | |
| 36 | 45985-1472 | 94.90 | 89.22 | | |
| 40 | 45985-1482 | 97.44 | 91.76 | | |
| 12 | 45985-1413 | 79.66 | 73.98 | 2.90 | 1.57 |
| 16 | 45985-1423 | 82.20 | 76.52 | | |
| 20 | 45985-1433 | 84.74 | 79.06 | | |
| 24 | 45985-1443 | 87.28 | 81.60 | | |
| 28 | 45985-1453 | 89.82 | 84.14 | | |
| 32 | 45985-1463 | 92.36 | 86.68 | | |
| 36 | 45985-1473 | 94.90 | 89.22 | | |
| 40 | 45985-1483 | 97.44 | 91.76 | | |

GUIDE & MOUNTING PEG OPTIONS

NOTE:
1. SEE SHEET 1 FOR ALL OTHER DIMENSIONS.

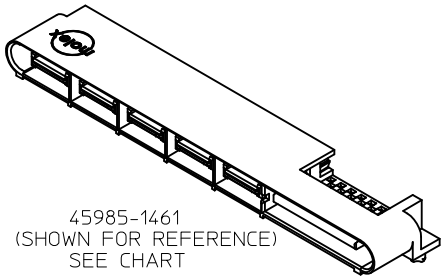

| | |
|----------------------------|-------------|
| SEE SHEET 1 | DESCRIPTION |
| EC NO: UCP2016-3486 | |
| DRWN:MBANDURA 2016/06/13 | |
| CHKD: | |
| APPR:BP ISZCZOR 2016/07/26 | |
| D2 | REV |

| GENERAL TOLERANCES (UNLESS SPECIFIED) | | |
|--|--------|-------|
| | mm | INCH |
| 4 PLACES | ± --- | ± --- |
| 3 PLACES | ± --- | ± --- |
| 2 PLACES | ± 0.25 | ± --- |
| 1 PLACE | ± --- | ± --- |
| ANGULAR ±1/2° | | |
| DRAFT WHERE APPLICABLE MUST REMAIN WITHIN DIMENSIONS | | |

| DIMENSION STYLE | |
|-----------------|------------|
| MM ONLY | |
| DRAWN BY | DATE |
| SCHAFER | 2005/06/20 |
| CHECKED BY | DATE |
| SAMIEC | 2005/06/21 |
| APPROVED BY | DATE |
| MARGULIS | 2005/06/22 |
| MATERIAL NO. | |
| SEE CHART | |

| | | |
|---|---------------------|------------------------|
| SCALE 1:1 | DESIGN UNITS METRIC | THIRD ANGLE PROJECTION |
| TITLE | | |
| LPH PLUG ASSEMBLY RT ANGLE 10 CIRCUIT POWER CONNECTOR | | |
| MOLEX INCORPORATED | | |
| DOCUMENT NO. | SHEET NO. | |
| SD-45985-100 | 4 OF 5 | |

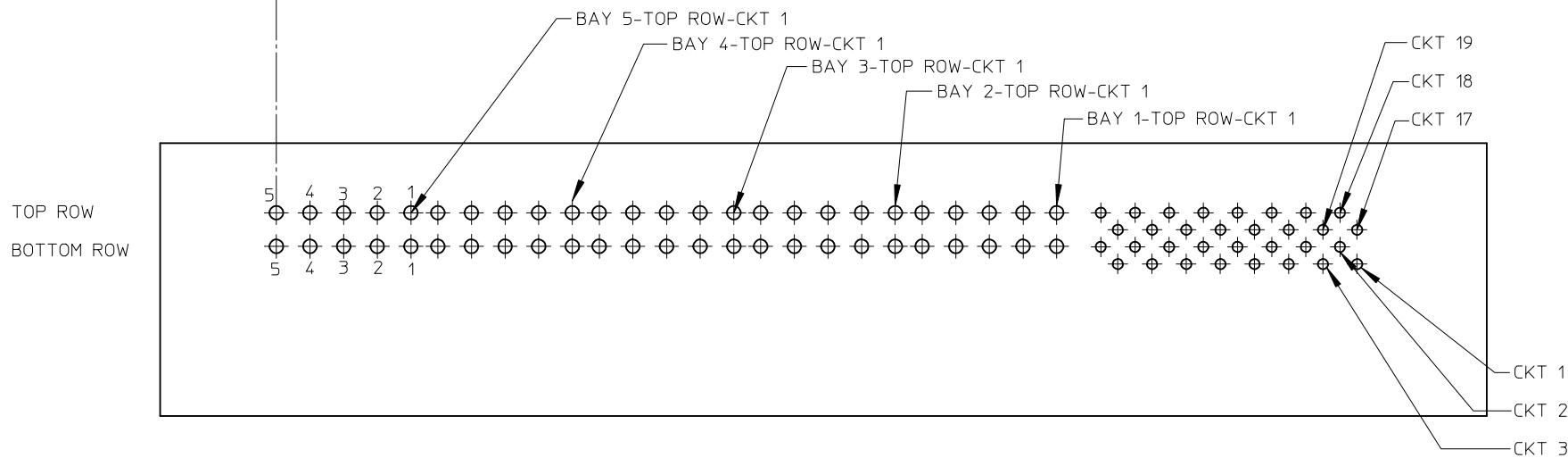
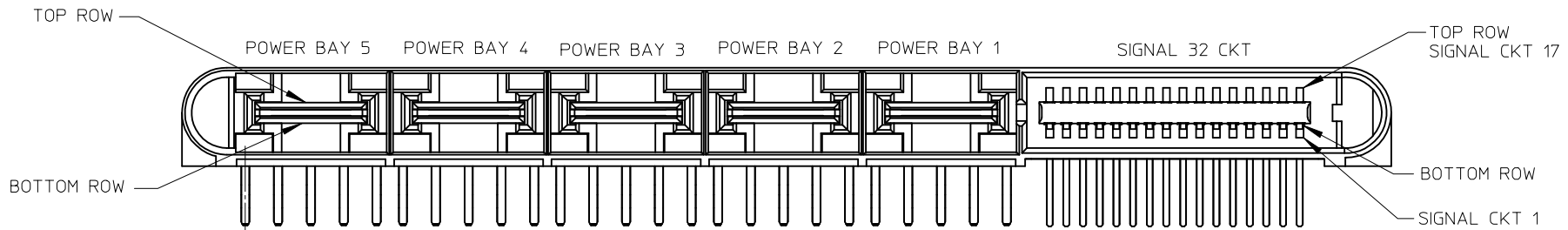

PCB LAYOUT: COMPONENT SIDE

| | | | | | | | | |
|---|---------------------------------------|--------|-----------------------------------|----------------------------------|---|---|------------------------|--|
| SEE SHEET 1 EC NO: UCP2016-3486 DRWN:MBANDURA 2016/06/13 CHKD: APPR:BP ISZCZOR 2016/07/26 DESCRIPTION REV | GENERAL TOLERANCES (UNLESS SPECIFIED) | | DIMENSION STYLE MM ONLY | | SCALE 1:1 | DESIGN UNITS METRIC | THIRD ANGLE PROJECTION | |
| | | mm | INCH | DRAWN BY SCHAFFER | DATE 2005/06/20 | TITLE LPH PLUG ASSEMBLY RT ANGLE 10 CIRCUIT POWER CONNECTOR | | |
| | 4 PLACES | ± --- | ± --- | CHECKED BY SAMIEC | DATE 2005/06/21 | | | |
| | 3 PLACES | ± --- | ± --- | APPROVED BY MARGULIS | DATE 2005/06/22 | MOLEX INCORPORATED DOCUMENT NO. SD-45985-100 SHEET NO. 5 OF 5 | | |
| | 2 PLACES | ± 0.25 | ± --- | MATERIAL NO. SEE CHART | | | | |
| 1 PLACE | ± --- | ± --- | ANGULAR ±1/2° | | THIS DRAWING CONTAINS INFORMATION THAT IS PROPRIETARY TO MOLEX INCORPORATED AND SHOULD NOT BE USED WITHOUT WRITTEN PERMISSION | | | |

DRAFT WHERE APPLICABLE MUST REMAIN WITHIN DIMENSIONS