

RECOMMENDED PCB LAYOUT AND KEEP-OUT ZONE

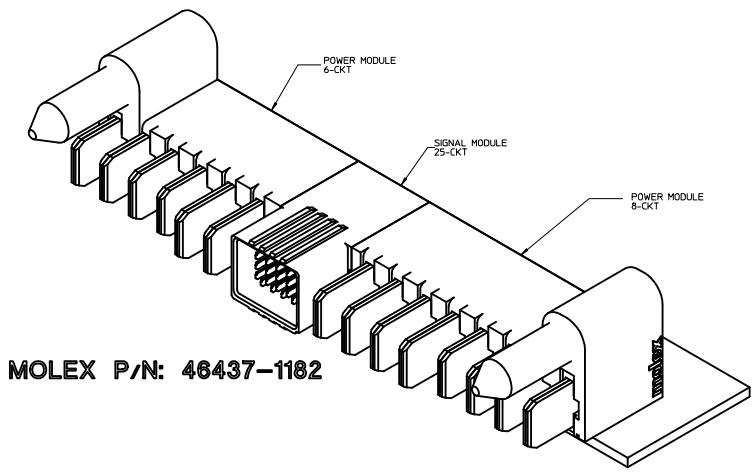
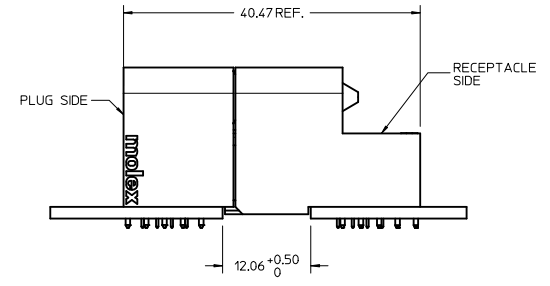
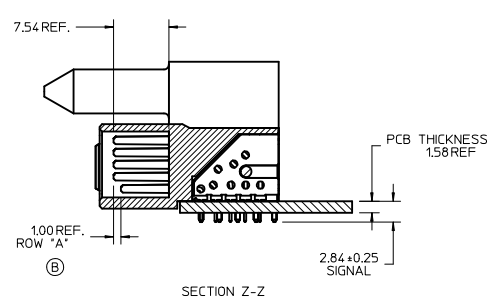
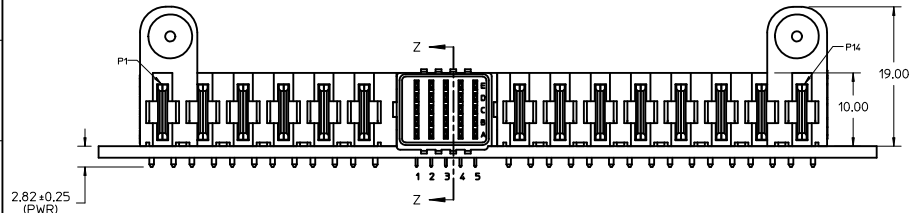

MOLEX P/N: 46437-1182

NOTES:

- MATERIAL:
-HOUSINGS: LCP UL94, V-0, COLOR: BLACK.
-TERMINALS: COPPER ALLOY.
-PLATING: 0.00127 NICKEL OVERALL WITH 0.00254 SELECTIVE MATTE TIN ON SOLDER TAILS AND 0.000762 SELECTIVE GOLD ON CONTACT AREA.
- PACKAGING: ASSEMBLIES TO BE TRAY PACKED PER PACKAGING SPEC PK-46437-002.
- INDIVIDUAL MODULES ARE RATED FOR VARIOUS VOLTAGE AND CURRENT RATINGS PER PS-46436-100.
- PC BOARD REQUIRES SOLDER THRU HOLES, REFER TO PS-46436-100 FOR DETAILS.
- PRODUCT TO MEET ROHS REQUIREMENTS.
- PLUG ASSY MATES TO MOLEX R/A RECEPTACLE P/N: 46436-1182.

LMF8 ROW A EC NO: UCP2011-1535 D: DRW: BKOSTIC 2010/11/23 CHKD: APPR: APATEL 2010/12/16 REV:	QUALITY SYMBOLS	GENERAL TOLERANCES (UNLESS SPECIFIED)	DIMENSION STYLE MM ONLY	SCALE 3:1	DESIGN UNITS METRIC	THIRD ANGLE PROJECTION																		
		<table border="1"> <tr> <th></th> <th>mm</th> <th>INCH</th> </tr> <tr> <td>4 PLACES</td> <td>±---</td> <td>±---</td> </tr> <tr> <td>3 PLACES</td> <td>±---</td> <td>±---</td> </tr> <tr> <td>2 PLACES</td> <td>±0.25</td> <td>±---</td> </tr> <tr> <td>1 PLACE</td> <td>±0.25</td> <td>±---</td> </tr> <tr> <td colspan="3">ANGULAR ±1/2°</td> </tr> </table>		mm	INCH	4 PLACES	±---	±---	3 PLACES	±---	±---	2 PLACES	±0.25	±---	1 PLACE	±0.25	±---	ANGULAR ±1/2°			DRAWN BY DATE BKOSTIC CHECKED BY DATE BKOSTIC APPROVED BY DATE APATEL 2010/12/16	TITLE	R/A PLUG ASSY 6P-25HDS-8P TEN60 POWER FAMILY	
		mm	INCH																					
4 PLACES	±---	±---																						
3 PLACES	±---	±---																						
2 PLACES	±0.25	±---																						
1 PLACE	±0.25	±---																						
ANGULAR ±1/2°																								
DRAFT WHERE APPLICABLE MUST REMAIN WITHIN DIMENSIONS		MATERIAL NO. 46437-1182	DOCUMENT NO. SD-46437-1182	MOLEX INCORPORATED SHEET NO. 1 OF 1																				

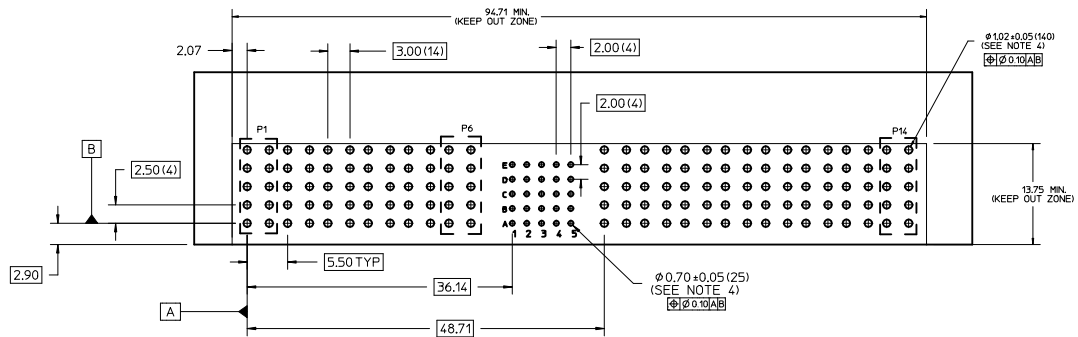
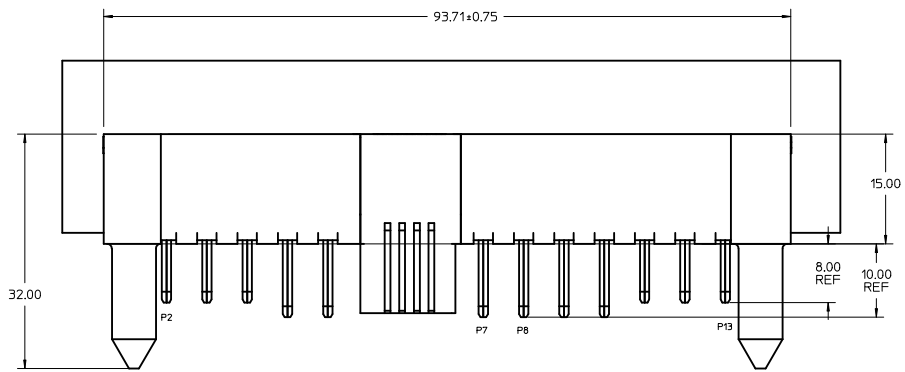

RECOMMENDED PCB LAYOUT AND KEEP-OUT ZONE

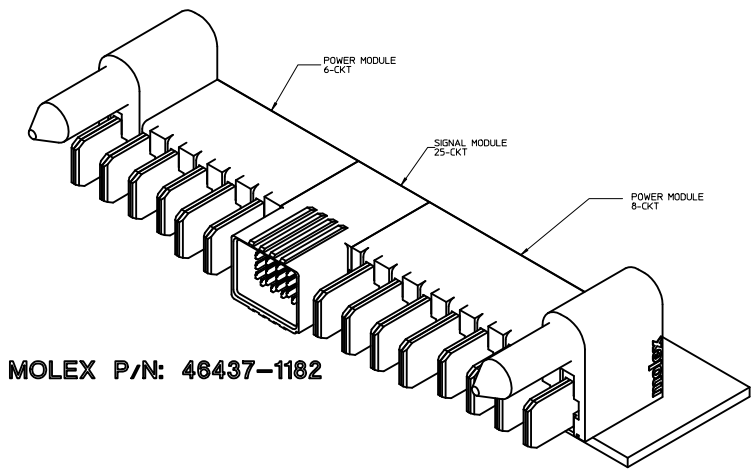
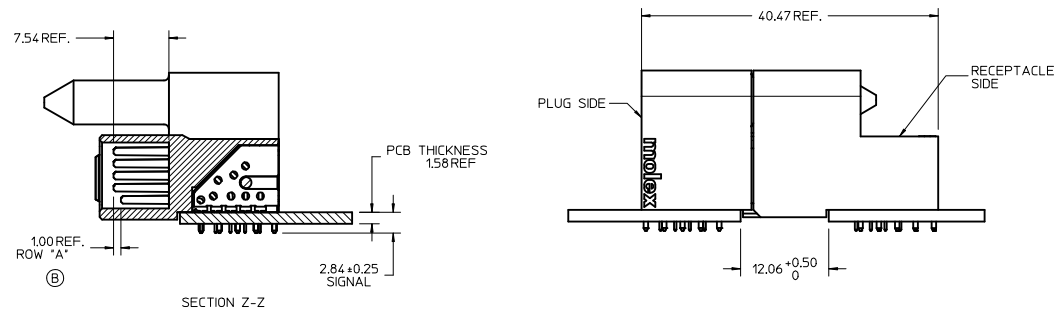
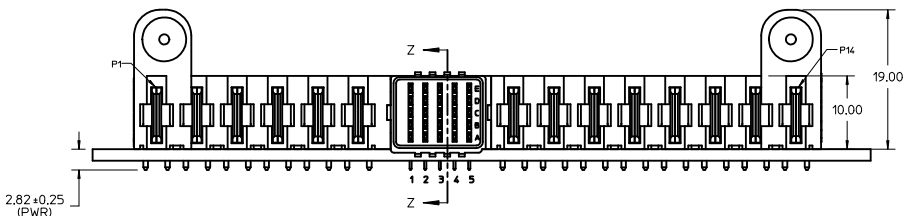

MOLEX P/N: 46437-1182

- NOTES:
- MATERIAL:
 - HOUSINGS: LCP UL94, V-0, COLOR: BLACK.
 - TERMINALS: COPPER ALLOY.
 - PLATING: 0.00127 NICKEL OVERALL WITH 0.00254 SELECTIVE MATTE TIN ON SOLDER TAILS AND 0.000762 SELECTIVE GOLD ON CONTACT AREA.
 - PACKAGING: ASSEMBLIES TO BE TRAY PACKED PER PACKAGING SPEC PK-46437-002.
 - INDIVIDUAL MODULES ARE RATED FOR VARIOUS VOLTAGE AND CURRENT RATINGS PER PS-46436-100.
 - PC BOARD REQUIRES SOLDER THRU HOLES, REFER TO PS-46436-100 FOR DETAILS.
 - PRODUCT TO MEET ROHS REQUIREMENTS.
 - PLUG ASSY MATES TO MOLEX R/A RECEPTACLE P/N: 46436-1182.

LMF8 ROW A EC NO: UCP2011-5335 D: DRW: BKOSTIC 2010/11/23 CHKD: APPR: APATEL 2010/12/16 REV:	QUALITY SYMBOLS	GENERAL TOLERANCES (UNLESS SPECIFIED)	DIMENSION STYLE MM ONLY	SCALE 3:1	DESIGN UNITS METRIC	THIRD ANGLE PROJECTION																		
		<table border="1"> <tr> <th></th> <th>mm</th> <th>INCH</th> </tr> <tr> <td>4 PLACES</td> <td>±---</td> <td>±---</td> </tr> <tr> <td>3 PLACES</td> <td>±---</td> <td>±---</td> </tr> <tr> <td>2 PLACES</td> <td>±0.25</td> <td>±---</td> </tr> <tr> <td>1 PLACE</td> <td>±0.25</td> <td>±---</td> </tr> <tr> <td colspan="3">ANGULAR ±1/2°</td> </tr> </table>		mm	INCH	4 PLACES	±---	±---	3 PLACES	±---	±---	2 PLACES	±0.25	±---	1 PLACE	±0.25	±---	ANGULAR ±1/2°			DRAWN BY DATE BKOSTIC CHECKED BY DATE BKOSTIC APPROVED BY DATE APATEL 2010/12/16	TITLE	R/A PLUG ASSY 6P-25HDS-8P TEN60 POWER FAMILY	
		mm	INCH																					
4 PLACES	±---	±---																						
3 PLACES	±---	±---																						
2 PLACES	±0.25	±---																						
1 PLACE	±0.25	±---																						
ANGULAR ±1/2°																								
DRAFT WHERE APPLICABLE MUST REMAIN WITHIN DIMENSIONS		MATERIAL NO. 46437-1182	DOCUMENT NO. SD-46437-1182	MOLEX INCORPORATED SHEET NO. 1 OF 1																				