

- NOTES:**
- MATERIALS:**  
HOUSING: LIQUID CRYSTAL POLYMER (LCP), GLASS-FILLED, UL 94V-0,  
COLOR: BLACK  
TERMINALS: BRASS.
  - FINISH:**  
TERMINAL: SELECTIVE GOLD (Au) IN THE CONTACT AREA;  
THICKNESS= .76 MICROMETER (30 MICROINCH) MINIMUM;  
SELECTIVE TIN (Sn) ALLOY IN THE PC TAIL AREA;  
THICKNESS= 1.27 MICROMETER (50 MICROINCH) MINIMUM;  
NICKEL (Ni) UNDERPLATE OVERALL.
  - ASSEMBLY MATES WITH MOLEX P/N SDA-71660-\*\*\*\*
  - CONFORMS TO PRODUCT SPEC: PS-71660.
- RECOMMENDED P.C. BOARD THICKNESS IS .062 (1.6).
- FOUR DIGIT DATE CODE (WK. YR.) EXAMPLE 26 96 LOCATED IN AREA SHOWN.
- TOOLING STATUS: \*X\* INDICATES NO TOOLING AVAILABLE. CONTACT FACTORY FOR FURTHER INFORMATION.

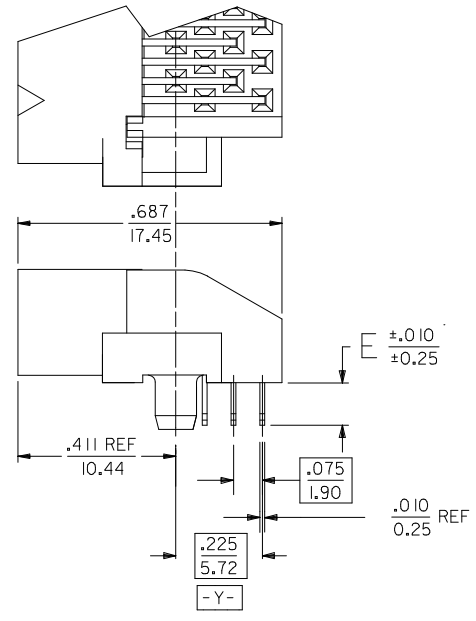

END DETAIL  
OPTION A  
(BOTH ENDS)

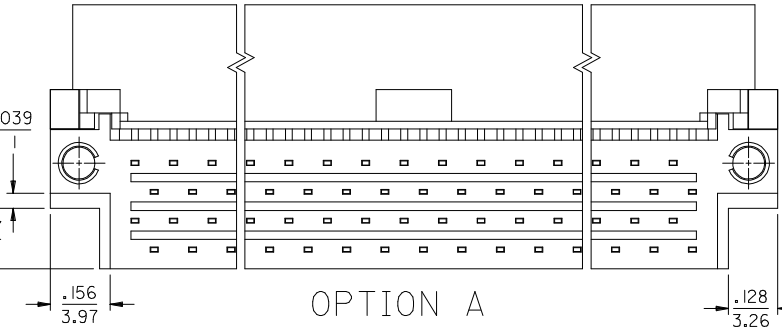
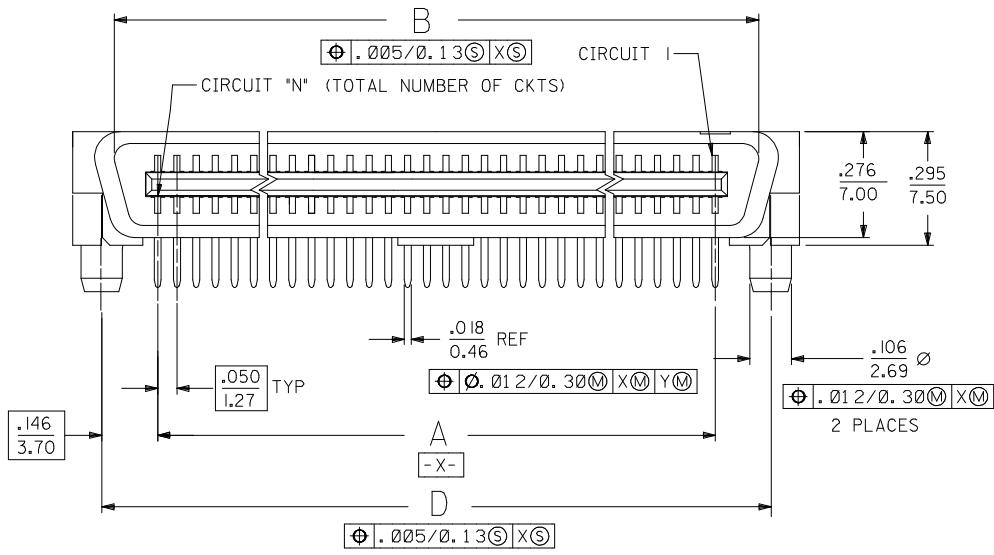

OPTION A

<b>CHANGE MATERIAL</b> EC NO: UCP2009-1254 DRWINHISIBARRA 2008/12/19 CHKD:BBARKER 2009/01/06 APPR:SMILLER 2009/01/06	QUALITY SYMBOLS ▽=0 ▽=0	GENERAL TOLERANCES (UNLESS SPECIFIED)		DIMENSION STYLE <b>IN/MM</b>		SCALE <b>4:1</b>	DESIGN UNITS <b>INCH</b>	THIRD ANGLE PROJECTION	
		4 PLACES ± --- ± --- 3 PLACES ± --- ± .010 2 PLACES ± 0.25 ± --- 1 PLACE ± --- ± --- ANGULAR ± 1/2°	mm INCH	DRAWN BY RKADAMS	DATE 2004/08/18	TITLE <b>SALES ASSEMBLY          EBBI 50D RIGHT ANGLE          PLUG CONNECTOR</b>		<b>MOLEX INCORPORATED</b>	
DRAFT WHERE APPLICABLE MUST REMAIN WITHIN DIMENSIONS	SEE TABLE	MATERIAL NO. <b>SD-71661-007</b>		DOCUMENT NO.		THIS DRAWING CONTAINS INFORMATION THAT IS PROPRIETARY TO MOLEX INCORPORATED AND SHOULD NOT BE USED WITHOUT WRITTEN PERMISSION			

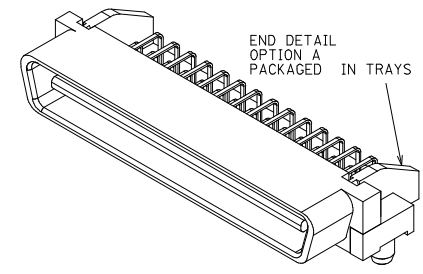
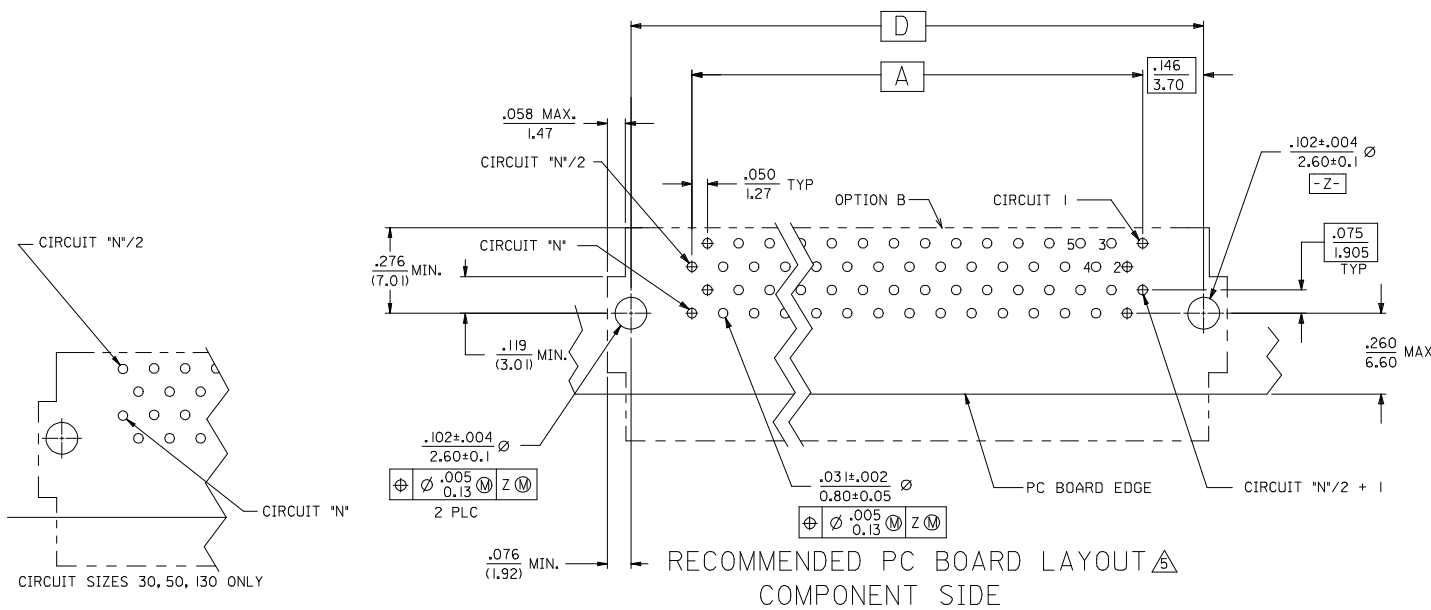

50 CIRCUIT ASSEMBLY SHOWN

		TRAY PACK PER SPEC. PK-70873-084*					END DETAIL OPTION 'A'
		D	C	B	A	CKT ('N')	ITEM NUMBER
.125 (3.18)	3.491 (88.68)	3.642 (92.50)	3.426 (87.02)	3.200 (81.28)	130		
	3.241 (82.33)	3.392 (86.15)	3.176 (80.67)	2.950 (74.93)	120		
	2.741 (69.63)	2.892 (73.45)	2.676 (67.97)	2.450 (62.23)	100		
	2.241 (56.93)	2.392 (60.75)	2.176 (55.27)	1.950 (49.53)	80		
	1.941 (49.31)	2.092 (53.13)	1.875 (47.65)	1.650 (41.91)	68		
	1.741 (44.23)	1.892 (48.05)	1.676 (42.57)	1.450 (36.83)	60		71661-2936
	1.491 (37.88)	1.642 (41.70)	1.426 (36.22)	1.200 (30.48)	50		
	1.241 (31.53)	1.392 (35.35)	1.176 (29.87)	.950 (24.13)	40		
	.991 (25.18)	1.142 (29.00)	.925 (23.52)	.700 (17.78)	30		
	.110 (2.79)	3.491 (88.68)	3.642 (92.50)	3.426 (87.02)	3.200 (81.28)	130	
3.241 (82.33)		3.392 (86.15)	3.176 (80.67)	2.950 (74.93)	120		
2.741 (69.63)		2.892 (73.45)	2.676 (67.97)	2.450 (62.23)	100		71661-2910
2.241 (56.93)		2.392 (60.75)	2.176 (55.27)	1.950 (49.53)	80		71661-2980
1.941 (49.31)		2.092 (53.13)	1.875 (47.65)	1.650 (41.91)	68		71661-2968
1.741 (44.23)		1.892 (48.05)	1.676 (42.57)	1.450 (36.83)	60		71661-2960
1.491 (37.88)		1.642 (41.70)	1.426 (36.22)	1.200 (30.48)	50		71661-2950
1.241 (31.53)		1.392 (35.35)	1.176 (29.87)	.950 (24.13)	40		
.991 (25.18)		1.142 (29.00)	.925 (23.52)	.700 (17.78)	30		71661-2930

<b>SEE SHEET 1</b> EC NO: LCP2009-1254 2008/12/19 DRWNS/IBARRA 2009/01/06 CHK/BBARKER APPR:SMILLER 2009/01/06	QUALITY SYMBOLS ▽=0 ▽=0	GENERAL TOLERANCES (UNLESS SPECIFIED)		DIMENSION STYLE IN/MM		SCALE	DESIGN UNITS	THIRD ANGLE PROJECTION
		4 PLACES ±--- ±--- 3 PLACES ±--- ±.010 2 PLACES ±0.25 ±--- 1 PLACE ±--- ±---		DRAWN BY DATE RKADAMS 2004/08/18		TITLE SALES ASSEMBLY EBBI 50D RIGHT ANGLE PLUG CONNECTOR		
		ANGULAR ±1/2°		CHECKED BY DATE BBARKER 2004/08/18		MOLEX INCORPORATED		
		DRAFT WHERE APPLICABLE MUST REMAIN WITHIN DIMENSIONS		APPROVED BY DATE SMILLER 2004/08/18		MATERIAL NO. SEE TABLE		DOCUMENT NO. SD-71661-007

20 19 18 17 16 15 14 13 12 11 10 9 8 7 6 5 4 3 2 1

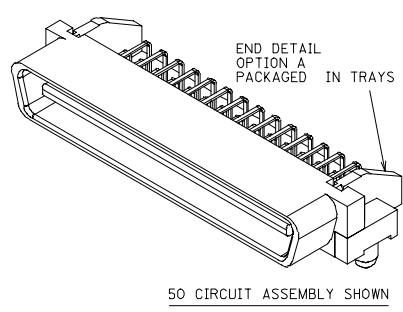
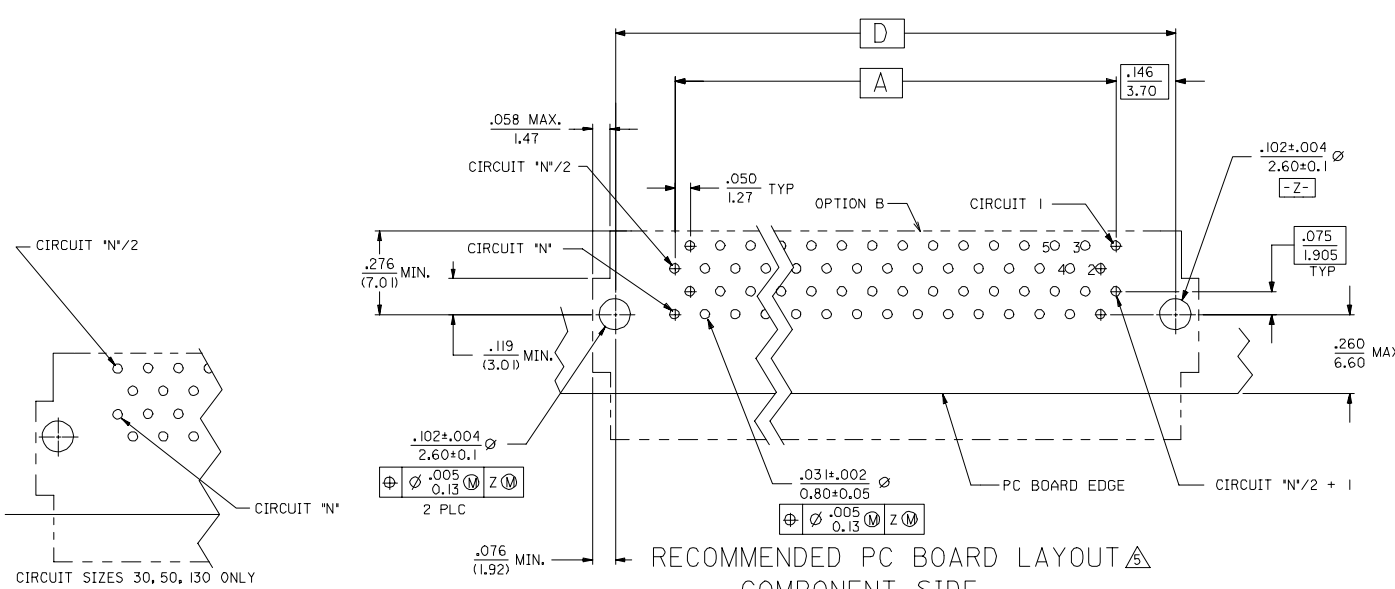

RECOMMENDED PC BOARD LAYOUT  
COMPONENT SIDE

TRAY PACK  
PER SPEC.  
PK-10873-084+  
END DETAIL  
OPTION 'A'

.125 (3.18)	3.491 (88.68)	3.642 (92.50)	3.426 (87.02)	3.200 (81.28)	130	
	3.241 (82.33)	3.392 (86.15)	3.176 (80.67)	2.950 (74.93)	120	
	2.741 (69.63)	2.892 (73.45)	2.676 (67.97)	2.450 (62.23)	100	
	2.241 (56.93)	2.392 (60.75)	2.176 (55.27)	1.950 (49.53)	80	
	1.941 (49.31)	2.092 (53.13)	1.875 (47.65)	1.650 (41.91)	68	
	1.741 (44.23)	1.892 (48.05)	1.676 (42.57)	1.450 (36.83)	60	71661-2936
	1.491 (37.88)	1.642 (41.70)	1.426 (36.22)	1.200 (30.48)	50	
	1.241 (31.53)	1.392 (35.35)	1.176 (29.87)	.950 (24.13)	40	
	.991 (25.18)	1.142 (29.00)	.925 (23.52)	.700 (17.78)	30	
	.110 (2.79)	3.491 (88.68)	3.642 (92.50)	3.426 (87.02)	3.200 (81.28)	130
3.241 (82.33)		3.392 (86.15)	3.176 (80.67)	2.950 (74.93)	120	
2.741 (69.63)		2.892 (73.45)	2.676 (67.97)	2.450 (62.23)	100	71661-2910
2.241 (56.93)		2.392 (60.75)	2.176 (55.27)	1.950 (49.53)	80	71661-2980
1.941 (49.31)		2.092 (53.13)	1.875 (47.65)	1.650 (41.91)	68	71661-2968
1.741 (44.23)		1.892 (48.05)	1.676 (42.57)	1.450 (36.83)	60	71661-2960
1.491 (37.88)		1.642 (41.70)	1.426 (36.22)	1.200 (30.48)	50	71661-2950
1.241 (31.53)		1.392 (35.35)	1.176 (29.87)	.950 (24.13)	40	
.991 (25.18)		1.142 (29.00)	.925 (23.52)	.700 (17.78)	30	71661-2930

E	D	C	B	A	CKT ('N')	ITEM NUMBER
---	---	---	---	---	-----------	-------------

ADD 71661-2960 EC NO: UCP2008-047 DRWN:SBARRA 2007/08/29 CHK:CBARKER 2007/09/14 APPR:SMILLER 2007/09/14	QUALITY SYMBOLS ▽=0 ▽=0	GENERAL TOLERANCES (UNLESS SPECIFIED)		DIMENSION STYLE IN/MM		SCALE	DESIGN UNITS	THIRD ANGLE PROJECTION	
		4 PLACES ± --- ± --- 3 PLACES ± --- ± .010 2 PLACES ± 0.25 ± --- 1 PLACE ± --- ± ---		mm INCH		---	INCH	☑	
		DRAFT WHERE APPLICABLE MUST REMAIN WITHIN DIMENSIONS		SEE TABLE		DRAWN BY DATE RKADAMS 08/18/2004 CHECKED BY DATE BBARKER 08/18/2004 APPROVED BY DATE SMILLER 08/18/2004		TITLE SALES ASSEMBLY EBB1 50D RIGHT ANGLE PLUG CONNECTOR	
		MATERIAL NO.		DOCUMENT NO.		MOLEX INCORPORATED		SHEET NO. 2 OF 2	

THIS DRAWING CONTAINS INFORMATION THAT IS PROPRIETARY TO MOLEX INCORPORATED AND SHOULD NOT BE USED WITHOUT WRITTEN PERMISSION