

**NOTES:**

1. MATERIALS: HOUSING--LIQUID CRYSTAL POLYMER (LCP), GLASS FILLED, UL94V-0, COLOR: BLACK, TERMINAL: PHOSPHOR BRONZE.
2. FINISH: 0.75 MICROMETERS MINIMUM SELECTIVE GOLD (Au) IN MATING AREA; 2.50 MICROMETERS MINIMUM SELECTIVE TIN (Sn) IN TAIL AREA; NICKEL (Ni) UNDERPLATE OVERALL.
3. THIS PART CONFORMS TO MOLEX PRODUCT SPECIFICATION PS-73670-9999.
4. FOR MIXED CONTACT MATING LENGTHS, CONSULT FACTORY FOR AVAILABILITY.
5. PACKAGE PER PK-70873-0818.
6. PARTS MARKED WITH PART NUMBER AND DATE CODE, ON EITHER SIDE, APPROXIMATELY WHERE SHOWN.

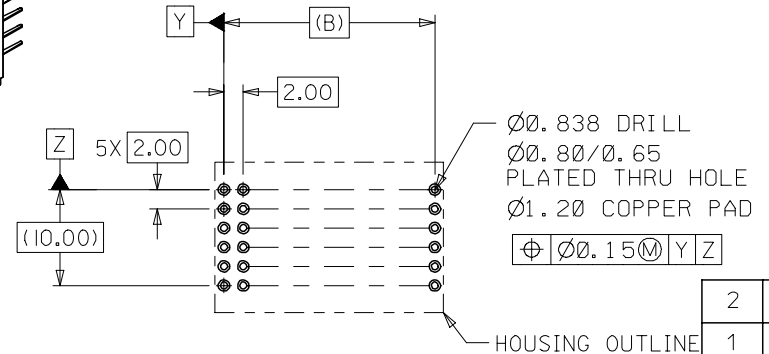
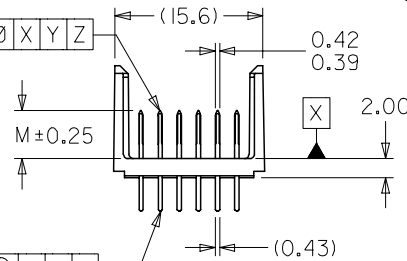
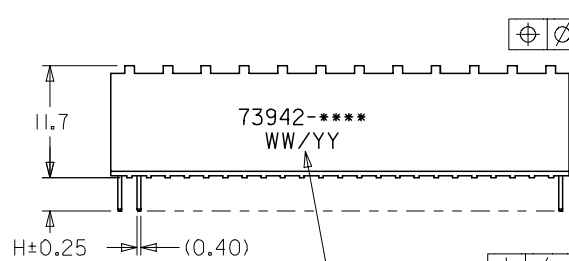
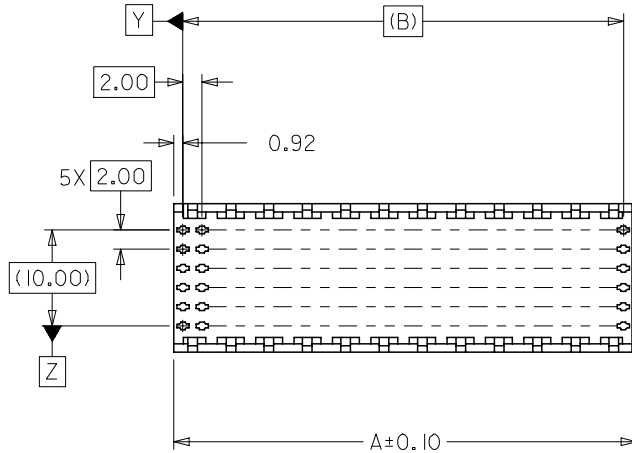
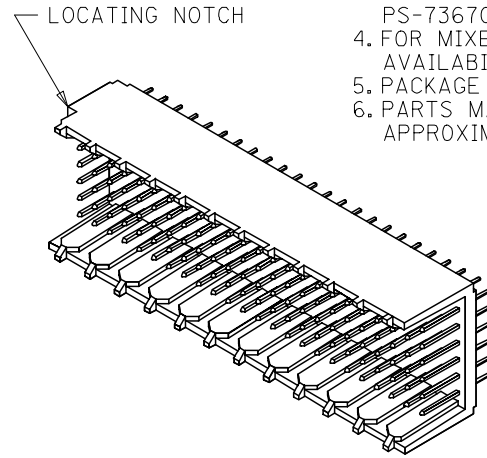

PCB LAYOUT: COMPONENT SIDE  
RECOMMENDED PCB THICKNESS: 2.50 MIN.

2	A
1	G
SHT	REV

SEE NOTE 6

MODIFY FINISH NOTE	QUALITY SYMBOLS
EC NO: UCP2007-2259	▽=0
IDRW:MSIBARRA 2007/03/13	▽=0
CHKD:BBARKER 2007/03/21	
APPR:SMILLER 2007/03/22	
DESCRIPTION	
REV	

GENERAL TOLERANCES (UNLESS SPECIFIED)	DIMENSION STYLE	SCALE	DESIGN UNITS	THIRD ANGLE PROJECTION
	MM ONLY	2:1	METRIC	
4 PLACES ± --- ± ---	DRAWN BY	DATE	TITLE	
3 PLACES ± --- ± ---	JB INGHAM	1998/01/13	SALES ASSY HDM BACKPLANE	
2 PLACES ± 0.05 ± ---	CHECKED BY	DATE	OPEN END OPTION	
1 PLACE ± 0.10 ± ---	SREED	1998/01/13	SOLDER TAIL VERSION	
ANGULAR ±1/2°	APPROVED BY	DATE	MOLEX INCORPORATED	
	CBIXLER	1998/01/13	MATERIAL NO. SEE CHART	
			DOCUMENT NO. SD-73942-001	
DRAFT WHERE APPLICABLE MUST REMAIN WITHIN DIMENSIONS			SHEET NO. 1 OF 2	



SIZE	THIS DRAWING CONTAINS INFORMATION THAT IS PROPRIETARY TO MOLEX INCORPORATED AND SHOULD NOT BE USED WITHOUT WRITTEN PERMISSION
B	

## MATERIAL NUMBER ASSIGNMENT

73942-\* \* 0 0

NUMBER	CIRCUIT SIZE	DIM "A"	DIM "B"	DIM "H"
0	72	23.84	22.00	2.0
1	144	47.84	46.00	2.0
2	72	23.84	22.00	2.5
3	144	47.84	46.00	2.5
4	72	23.84	22.00	3.0
5	144	47.84	46.00	3.0
6	72	23.84	22.00	3.5
7	144	47.84	46.00	3.5

NUMBER	DIM "M"
0	5.0
1	5.5
2	6.0

SEE SHEET 1 EC No. U81577 DRWN:JBINGHAM 98/0203 CHK: SREED 98/0203 APPR:CBIXLER 98/0203	MAJOR  CRITICAL 	QUALITY SYMBOLS	GENERAL TOLERANCES: (UNLESS SPECIFIED)	SCALE ---:--	DESIGN UNITS <input checked="" type="checkbox"/> mm <input type="checkbox"/> INCH	DIMENSIONS: <input type="checkbox"/> mm INCH <input type="checkbox"/> INCH mm <input checked="" type="checkbox"/> mm ONLY	SHT REV				
		DRAWN BY & DATE JBINGHAM 98/01/13	CHECKED BY & DATE SREED 98/01/13		APPROVED BY & DATE CBIXLER 98/01/13		TITLE: SALES ASSY, HDM BACKPLANE OPEN END OPTION SOLDER TAIL VERSION				
		ANGLAR: ± °		DRAFT WHERE APPLICABLE MUST REMAIN WITHIN DIMENSIONS		CAD FILENAME S73942X2.DGN		MATERIAL NO. SEE CHART		DRAWING NO. SD-73942-001	SHEET NO. 2
		THIS DRAWING CONTAINS INFORMATION THAT IS PROPRIETARY TO MOLEX INCORPORATED AND SHOULD NOT BE USED WITHOUT WRITTEN PERMISSION.								SIZE B	