









20 19 18 17 16 15 14 13 12 11 10 9 8 7 6 5 4 3 2 1

MATERIAL NUMBER PCB THICKNESS >4.0 - 9.0	MATERIAL NUMBER PCB THICKNESS 18 - 4.0	BUSHING CLOCK POSITION
74952-5901	74952-5001	A 
74952-5902	74952-5002	B 
74952-5903	74952-5003	C 
74952-5904	74952-5004	D 
74952-5905	74952-5005	E 
74952-5906	74952-5006	F 
74952-5907	74952-5007	G 
74952-5908	74952-5008	H 

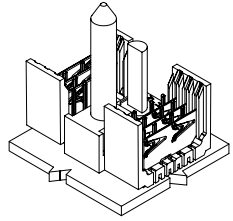
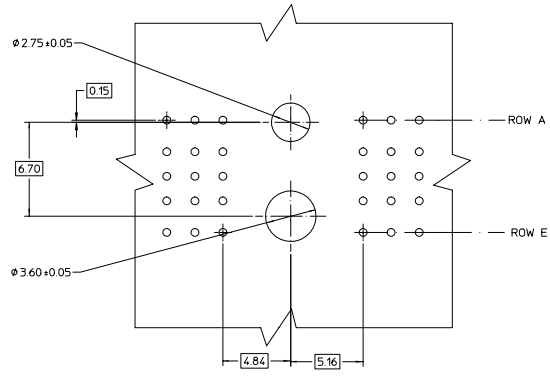
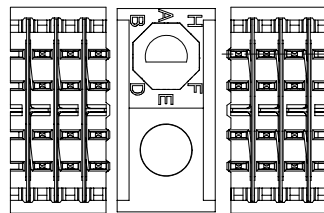

**BILL OF MATERIAL FOR 74952-50\*\***

ITEM	DESCRIPTION	QTY.
1	GUIDE PIN	1
2	GUIDANCE & POLARIZING MODULE	1
3	KEYING PIN	1
4	SCREW & WASHER (PCB 18-4.0)	1

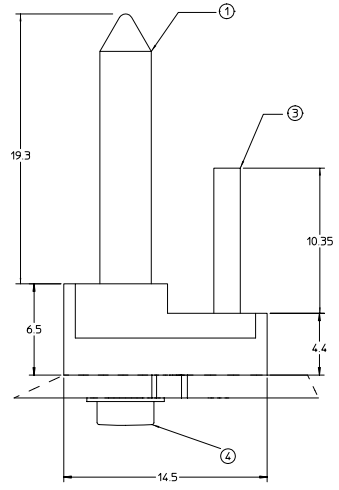
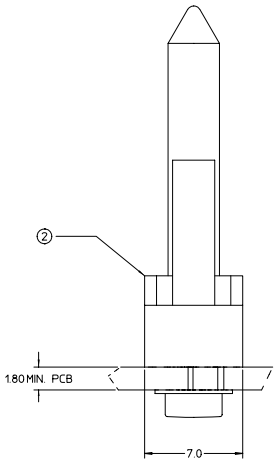

**BILL OF MATERIAL FOR 74952-59\*\***

ITEM	DESCRIPTION	QTY.
1	GUIDE PIN	1
2	GUIDANCE & POLARIZING MODULE	1
3	KEYING PIN	1
4	SCREW & WASHER (PCB >4.0-9.0)	1

- NOTES:
- MATERIAL:  
HOUSING: LIQUID CRYSTAL POLYMER (LCP),  
COLOR: BLACK  
GUIDE PIN / KEYING PIN: STAINLESS STEEL
  - THIS PART CONFORMS TO MOLEX PRODUCT SPECIFICATION PS-74031-999.
  - PACKAGING: STANDARD BULK PACK, 100 PER BAG PACKAGE SCREW SEPARATELY.

EC NO. UDT2002-0216 DRWN: LMSLEY 2001/12/19 CHKD: SREED 2001/12/19 APPR: CBIXLER 2001/12/20	QUALITY SYMBOLS ▽-0 ▽-0	GENERAL TOLERANCES (UNLESS SPECIFIED)		SCALE 6:1	DESIGN UNITS METRIC	THIRD ANGLE PROJECTION REVISE ON CAD ONLY
		4 PLACES ± --- ± --- 3 PLACES ± --- ± --- 2 PLACES ± --- ± --- 1 PLACE ± --- ± ---		DIMENSION STYLE MM ONLY		
		ANGULAR ± 2 °		DRAWN BY NMARTIN	DATE 01/12/11	
		DRAFT WHERE APPLICABLE MUST REMAIN WITHIN DIMENSIONS		CHECKED BY SREED	DATE 01/12/11	
		APPROVED BY CBIXLER	DATE 01/12/11	TITLE BACKPLANE GUIDANCE AND POLARIZING MODULE 5 ROW HSD SALES DRAWING		MOLEX MOLEX INCORPORATED MATERIAL NO. SEE CHART DOCUMENT NO. SD-74952-002 SHEET NO. 1 OF 1
THIS DRAWING CONTAINS INFORMATION THAT IS PROPRIETARY TO MOLEX INCORPORATED AND SHOULD NOT BE USED WITHOUT WRITTEN PERMISSION						