

PLEASE CHECK WWW.MOLEX.COM FOR LATEST PART INFORMATION

Part Number: [75235-2243](#)
Status: **Active**
Overview: GbX® Backplane Connector System
Description: 1.85mm by 1.85mm Pitch 4-Pair GbX® Backplane Connector System, Left Guide Header, 200 Circuits, Gold (Au) 0.76µm, Pin Length 3.55mm

Documents:

[Drawing \(PDF\)](#) [RoHS Certificate of Compliance \(PDF\)](#)
[Product Specification PS-75221-999 \(PDF\)](#)

Agency Certification

UL E29179

General

Product Family Backplane Connectors
 Series [75235](#)
 Application Backplane
 Application Tooling Documents TM-622022099
 Comments Left Guide Header, Keying Position D
 Component Type PCB Header
 Overview [GbX® Backplane Connector System](#)
 Product Name GbX®
 Style N/A
 UPC 822350175807

Physical

Circuits (Loaded) 200
 Circuits (maximum) 200
 Color - Resin Gray (Dark)
 Durability (mating cycles max) 200
 First Mate / Last Break No
 Flammability 94V-0
 Guide to Mating Part Yes
 Keying to Mating Part Yes
 Material - Metal High Performance Alloy (HPA), Stainless Steel
 Material - Plating Mating Gold
 Material - Plating Termination Tin-Lead
 Material - Resin High Temperature Thermoplastic
 Net Weight 4.537/g
 Number of Columns 25
 Number of Pairs 4
 Number of Rows 8
 Orientation Vertical
 PC Tail Length 2.20mm
 PCB Locator No
 PCB Retention Yes
 PCB Thickness - Recommended 1.60mm
 Packaging Type Tray
 Pitch - Mating Interface 1.85mm
 Pitch - Termination Interface 1.85mm
 Plating min - Mating 0.762µm
 Plating min - Termination 0.762µm
 Polarized to PCB No
 Stackable No
 Surface Mount Compatible (SMC) Yes
 Temperature Range - Operating 105°C

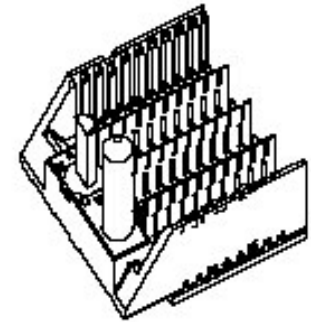

image - Reference only

Series

EU RoHS

ELV and RoHS Compliant
REACH SVHC
 Not Reviewed
Low-Halogen Status
Not Reviewed

China RoHS



Need more information on product environmental compliance?

Email productcompliance@molex.com
 For a multiple part number RoHS Certificate of Compliance, [click here](#)

Please visit the [Contact Us](#) section for any non-product compliance questions.

Search Parts in this Series

[75235Series](#)

Mates With

[75220 GbX® Daughtercard](#)

Application Tooling | FAQ

Tooling specifications and manuals are found by selecting the products below. Crimp Height Specifications are then contained in the Application Tooling Specification document.

Global

Description	Product #
Insertion Tool, 4-pair by 25-Wide	0622022020
Single Pin Repair Tool	0622022090
Shield Removal Tool	0622022100

Termination Interface: Style

Through Hole - Compliant Pin

Electrical

Current - Maximum per Contact

1A

Data Rate

8.0 Gbps

Real Signals (per 25mm)

108

Shield Type

Ground Plane Shield

Shielded

Yes

Voltage - Maximum

120V AC (RMS)/DC

Material Info

Reference - Drawing Numbers

Product Specification

PS-75221-999

Sales Drawing

SD-75235-210, SD-75838-210

GbX is a registered trademark of Amphenol Corporation.

This document was generated on 01/03/2013

PLEASE CHECK WWW.MOLEX.COM FOR LATEST PART INFORMATION