

PART NO.
DWG. NO.

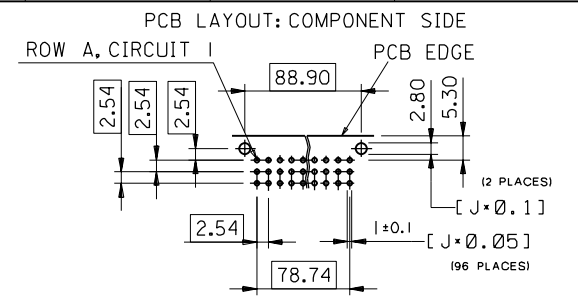

1) tails to fit in PC-board layout

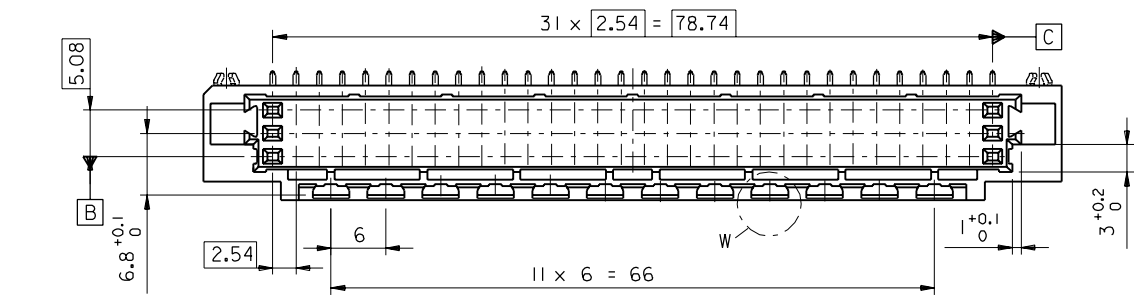
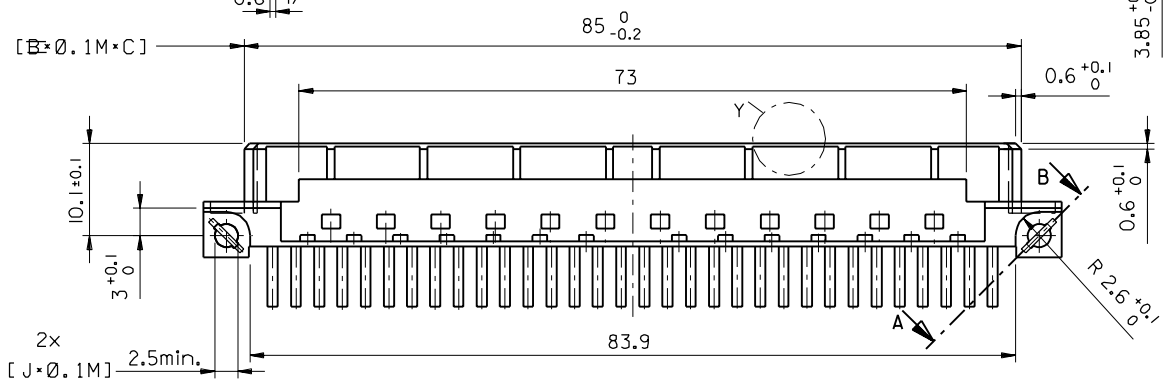
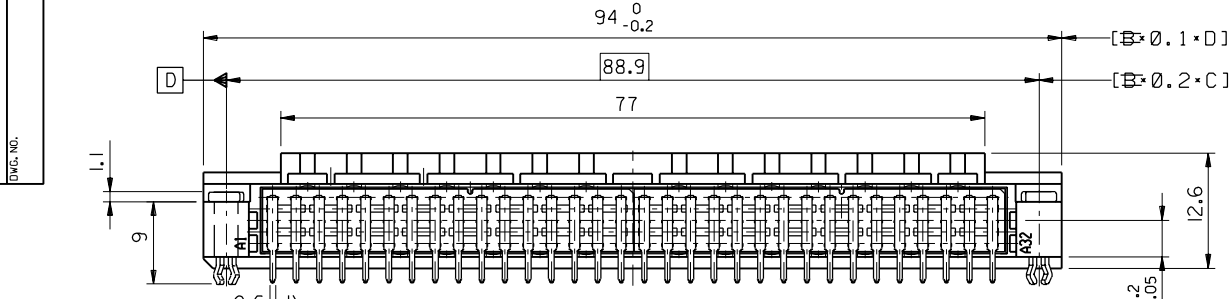
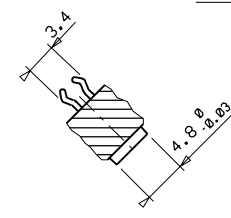
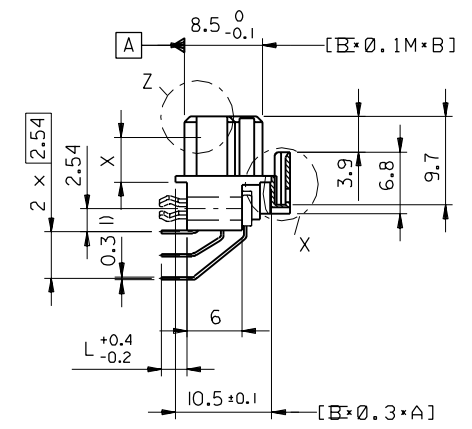

Section A - B

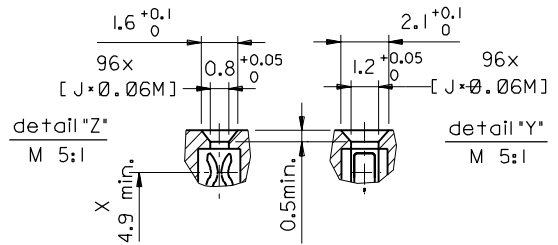
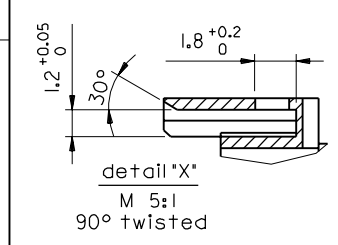
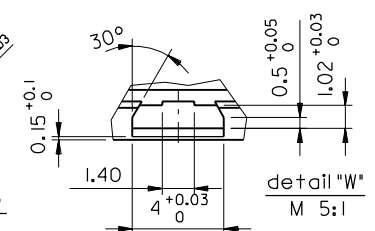

ECN MG1998-2586 hole pattern/L+0.4-0.2 97-09-15 KN	LTR FOR PREVIOUS REVISIONS SEE MRI LIST	FIRST ANGLE PROJECTION		REVISE ONLY ON CAD SYSTEM		SH.	REV.
		UNLESS OTHERWISE SPECIFIED TOLERANCES: ANGULAR ± 2° INCH METRIC	DRWG BY KN	SIGN	CAD/CAM PROJECT NAME 85052000 s12	THIS DRAWING CONTAINS INFORMATION THAT IS PROPRIETARY TO MOLEX INC. & SHOULD NOT BE USED WITHOUT WRITTEN PERMISSION	
3 PLACE ±	±	DRWG BY Ca	SIGN	TITLE 96 pos. female connector DIN 41612 style Q,+ clip with coding, dimensions	SHEET NO. DATE 2 of 2 96/04/30		
2 PLACE ±	±	APP'D BY JB	SIGN	MOLEX MOLEX EUROPE	PART NO. DWG NO. SIZE SDA-85052-0001 B		
1 PLACE ±	±	SCALE 2:1					
DESIGN DIMENSION <input checked="" type="checkbox"/> MM <input type="checkbox"/> IN.							
EQUIVALENT DIMENSION <input type="checkbox"/> MM <input type="checkbox"/> IN.							
IF TWO DIMENSIONS ARE SHOWN THE UPPER IS THE DESIGN DIMENSION, LOWER IS SECONDARY							

