

Distributed by:

JAMECO[®]
ELECTRONICS

www.Jameco.com ♦ 1-800-831-4242

The content and copyrights of the attached
material are the property of its owner.

Jameco Part Number 463531

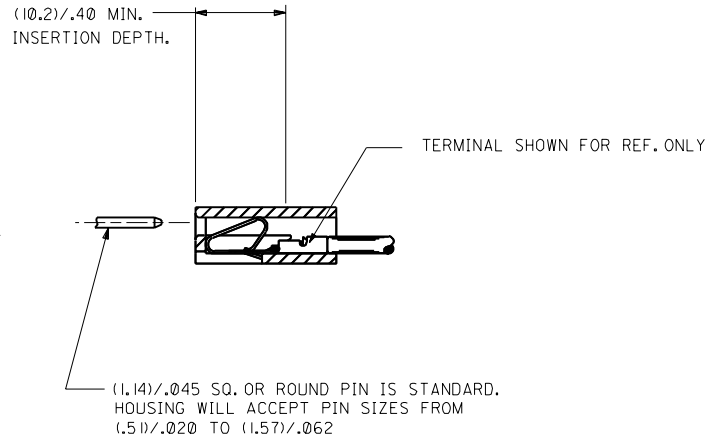
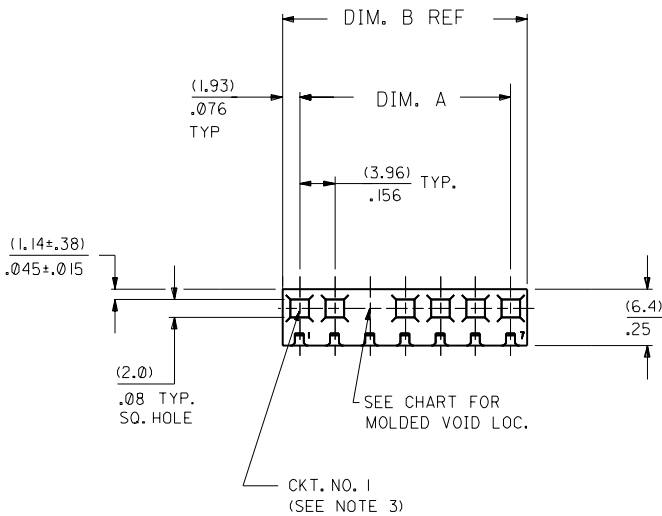

DIM. A	DIM. B	NO. OF
(3.96±.13)	(7.82)	2
.156±.005	.308	
(7.92±.13)	(11.79)	3
.312±.005	.464	
(11.89±.13)	(15.75)	4
.468±.005	.620	
(15.85±.13)	(19.71)	5
.624±.005	.776	
(19.81±.13)	(23.67)	6
.780±.005	.932	
(23.77±.13)	(27.64)	7
.936±.005	1.088	
(27.74±.25)	(31.60)	8
1.092±.010	1.244	
(31.70±.25)	(35.56)	9
1.248±.010	1.400	
(35.66±.25)	(39.52)	10
1.404±.010	1.556	
(39.62±.25)	(43.48)	11
1.560±.010	1.712	
(43.59±.25)	(47.45)	12
1.716±.010	1.868	
(47.55±.31)	(51.41)	13
1.872±.012	2.024	
(51.51±.36)	(55.37)	14
2.028±.014	2.180	
(55.47±.36)	(59.33)	15
2.184±.014	2.336	
(59.44±.36)	(63.30)	16
2.340±.014	2.492	
(63.40±.36)	(67.26)	17
2.496±.014	2.648	
(67.36±.36)	(71.22)	18
2.652±.014	2.804	
(71.32±.36)	(75.18)	19
2.808±.014	2.960	
(75.29±.36)	(79.15)	20
2.964±.014	3.116	
(79.25±.46)	(83.11)	21
3.120±.018	3.272	
(83.21±.46)	(87.07)	22
3.276±.018	3.428	
(87.17±.46)	(91.03)	23
3.432±.018	3.584	
(91.14±.46)	(95.00)	24
3.588±.018	3.740	

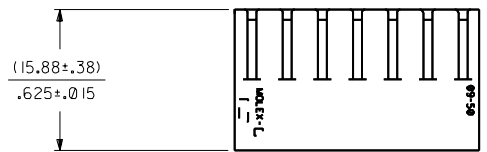

OPTION CODE

OPT. CODE	RAMP	POL. RIB	EARS	MATERIAL	ENGRAVING	PACKAGING
A	STD. RAMP	NO	NO	NYLON 94V-2	STD.	PK-2139-001
C	NONE	NO	NO	NYLON 94V-2	STD.	PK-2139-002
G	WIDE RAMP	NO	NO	NYLON 94V-2	STD.	PK-2139-001
M	STD. RAMP	NO	NO	NYLON 6 94V-2	STD.	TBD-INDIA
N	NONE	NO	NO	NYLON 6 94V-2	STD.	TBD-INDIA
P	STD. RAMP	YES	NO	NYLON 94V-2	STD.	TBD SINGAPORE

NO. OF CKT'S. 2139-N***-***

SELECTIVE RAMP LOC.
 BLANK=NONE
 AA=1ST. SEL. LOC.
 AB=2ND. SEL. LOC., ETC.

VOID CODE
 NO. CORRESPONDS TO
 CKT. NO. VOIDED.
 MULT. VOIDS START WITH 51.

COLOR CODE
 BLANK=NATURAL
 GN=GREEN
 YW=YELLOW
 RD=RED
 OR=ORNAGE
 BU=BLUE
 BK=BLACK

- NOTES:
- THIS HOUSING FOR USE WITH TERMINAL NO. 2478 (18 TO 24 GA) & 2578 (22 TO 26 GA), WITH (2.54) / .100 MAX. INSULATION DIA.. HOUSING 41695 IS RECOMMENDED FOR OVER (2.54) / .100 DIA. INSULATION.
 - DIMENSIONS GIVEN ACROSS CENTERLINES ARE SYMMETRICAL ABOUT THOSE CENTERLINES WITHIN HALF THE TOTAL TOLERANCE.
 - FIRST CKT. NO. ON 1 THRU 5 CKT. HOUSINGS. FIRST AND LAST CKT. NO. ON 6 CKT. HOUSINGS AND LARGER.
 - MAX BOW .005 MM/MM OR .005 IN/IN
 - PARTS CONFORM TO PRODUCT SPECIFICATION PS-08-50.
 - 2139-NP-# IN MANUFACTURED IN SINGAPORE ONLY

MFG. SH. REV. LTR. REVISIONS

4	AE
3	AB
2	AB1
1	AE

OBS PARTS JCR2001-0981 1/25/01 SAMEEC

REVISIONS

CONECTOR HOUSING, .156 CRIMP TERMINAL 2139 SERIES DWG

MOLEX INCORPORATED SHEET NO. DATE
 TITLE 10F 4 1 / 17 / 86

SEE CHART SD-2139

DRG. NAME: APPLICABLE MUST REMAIN WITHIN DIMENSIONS

DRG. NO. PART NO. DRG. NO.

DRG. FILE: S2139X1 SCALE: 1:1

DRG. DATE: 1/17/86

DRG. BY: LENZ

DRG. CHECK: PATEL

DRG. APPROV: LENZ

DRG. DATE: 1/17/86

DRG. FILE: S2139X1

DRG. NO. PART NO. DRG. NO.

DRG. DATE: 1/17/86

DRG. BY: LENZ

DRG. CHECK: PATEL

DRG. APPROV: LENZ

20

19

18

17

16

15

14

13

12

11

2139

9

8

7

6

2139

4

3

2

1

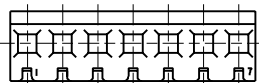
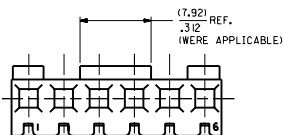
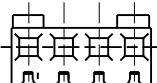
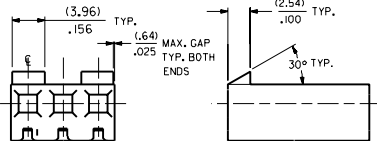

STD. RAMP OPTION
SEE CHART FOR RAMP LOCATIONS.

NO. OF CKT-S.	STANDARD RAMP IS LOCATED ON ♻ OF CKT. NOS.
2	ACROSS ENTIRE PART
3	1,3
4	1,4
5	1,3,5
6	1,3,4,6
7	ACROSS ENTIRE PART
8	1,3,6,8
9	ACROSS ENTIRE PART
10	1,3,5,6,8,10
11	ACROSS ENTIRE PART
12	1,3,5,8,10,12
13	1,3,5,7,9,11,13
14	1,3,5,7,8,10,12,14
15	1,3,5,7,9,11,13,15
16	1,3,5,7,10,12,14,16
17	1,3,5,7,9,11,13,15,17
18	1,3,5,7,9,10,12,14,16,18
19	1,3,5,7,9,11,13,15,17,19
20	1,3,5,7,9,12,14,16,18,20
21	1,3,5,7,9,11,13,15,17,19,21
22	1,3,5,7,9,11,12,14,16,18,20,22
23	1,3,5,7,9,11,13,15,17,19,21,23
24	1,3,5,7,9,11,14,16,18,20,22,24

2139-NA-*

2139-NC-*

ORDER NO.	ENG. NO.	VOIDS	ORDER NO.	ENG. NO.	VOIDS
09-50-3021	2139-2A		09-50-7021	2139-2C	
09-50-3031	2139-3A		09-50-7031	2139-3C	
09-50-3041	2139-4A		09-50-7041	2139-4C	
09-50-3051	2139-5A		09-50-7051	2139-5C	
09-50-3061	2139-6A		09-50-7061	2139-6C	
09-50-3071	2139-7A		09-50-7071	2139-7C	
09-50-3081	2139-8A		09-50-7081	2139-8C	
09-50-3091	2139-9A		09-50-7091	2139-9C	
09-50-3101	2139-10A		09-50-7101	2139-10C	
09-50-3111	2139-11A		09-50-7111	2139-11C	
09-50-3121	2139-12A		09-50-7121	2139-12C	
09-50-3131	2139-13A		09-50-7131	2139-13C	
09-50-3141	2139-14A		09-50-7141	2139-14C	
09-50-3151	2139-15A		09-50-7151	2139-15C	
09-50-3161	2139-16A		09-50-7161	2139-16C	
09-50-3171	2139-17A		09-50-7171	2139-17C	
09-50-3181	2139-18A		09-50-7181	2139-18C	
09-50-3191	2139-19A		09-50-7191	2139-19C	
09-50-3201	2139-20A		09-50-7201	2139-20C	
09-50-3211	2139-21A		09-50-7211	2139-21C	
09-50-3221	2139-22A		09-50-7221	2139-22C	
09-50-3231	2139-23A		09-50-7231	2139-23C	
09-50-3241	2139-24A		09-50-7241	2139-24C	
09-50-3036	2139-3A-2	2	09-50-7117	2139-11C-51	2,7,10
	2139-10A-2	2	09-50-7166	2139-16C-2	2
	2139-10A-51	2,5	09-50-7106	2139-10C-2	2
	2139-7A-2	2	09-50-7107	2139-10C-51	2,5
	2139-11A-51	2,7,10	09-50-7076	2139-7C-2	2
09-50-3163	2139-16A-2	2		2139-4C-3	3
09-50-3073	2139-10A-7	7	T 09-50-7108	2139-10C-4	4
09-50-3083	2139-10A-8	8	T 09-50-7109	2139-10C-5	5
09-50-3104	2139-10A-9	9		2139-5C-2	2
09-50-3162	2139-16A-51	2,15	09-50-3077	2139-7C-3	3
09-50-3092	2139-9A-51	2,6	09-50-3078	2139-7C-5	5
09-50-3075	2139-7A-51	1,7	09-50-7142	2139-14C-5	5
	2139-7A-6	6			
	2139-5A-51	2,4			
09-50-3047	2139-4A-3	3			
	2139-11A-2	2			
09-50-3052	2139-5A-4	4			
09-50-3076	2139-7A-52	4,7			
09-50-3125	2139-12A-5	5			
	2139-7A-3	3			
	2139-7A-5	5			
09-50-3053	2139-5A-2	2			
	2139-9A-2	2			
09-50-3127	2139-12A-2	2			
09-50-3143	2139-14A-2	2			
09-50-3202	2139-20A-2	2			
	2139-9A-4	4			
09-50-3126	2139-12A-11	11			
09-50-3142	2139-14A-13	13			
09-50-3084	2139-8A-4	4			
09-50-3037	2139-3A-3	3			
09-50-3182	2139-18A-2	2			
09-50-3157	2139-15A-2	2			

SEE SHEET 1	SEE SHEET 1	SEE SHEET 1	SEE SHEET 1	SEE SHEET 1	SEE SHEET 1
SEE SHEET 1	SEE SHEET 1	SEE SHEET 1	SEE SHEET 1	SEE SHEET 1	SEE SHEET 1
SEE SHEET 1	SEE SHEET 1	SEE SHEET 1	SEE SHEET 1	SEE SHEET 1	SEE SHEET 1
SEE SHEET 1	SEE SHEET 1	SEE SHEET 1	SEE SHEET 1	SEE SHEET 1	SEE SHEET 1
SEE SHEET 1	SEE SHEET 1	SEE SHEET 1	SEE SHEET 1	SEE SHEET 1	SEE SHEET 1
SEE SHEET 1	SEE SHEET 1	SEE SHEET 1	SEE SHEET 1	SEE SHEET 1	SEE SHEET 1
SEE SHEET 1	SEE SHEET 1	SEE SHEET 1	SEE SHEET 1	SEE SHEET 1	SEE SHEET 1
SEE SHEET 1	SEE SHEET 1	SEE SHEET 1	SEE SHEET 1	SEE SHEET 1	SEE SHEET 1
SEE SHEET 1	SEE SHEET 1	SEE SHEET 1	SEE SHEET 1	SEE SHEET 1	SEE SHEET 1
SEE SHEET 1	SEE SHEET 1	SEE SHEET 1	SEE SHEET 1	SEE SHEET 1	SEE SHEET 1

REVISIONS ONLY ON CAD SYSTEM

CONNECTOR HOUSING,
.1564 CRIMP TERMINAL
2139 SERIES DWG.

MOLEX INCORPORATED
DATE: 11/17/86

SEC CHART SD-2139
SHEET 2 OF 2

20

19

18

17

16

15

14

13

12

11

2139

9

8

7

6

2139

4

3

2

1