

MATERIAL NO.	ENGINEERING NO.	LENGTH	POLES
1206144001	LW03000C02M020	78.7 (2M)	3
1206144002	LW04000C02M020	78.7 (2M)	4

NOTICE: THIS PART IS CSA AND FACTORY MUTUAL APPROVED  
NO CHANGES CAN BE MADE TO THE ASSEMBLY, COMPONENTS  
OR SUPPLIER WITHOUT PRIOR APPROVAL FROM CSA AND  
FACTORY MUTUAL.

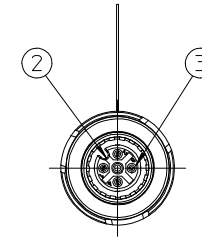
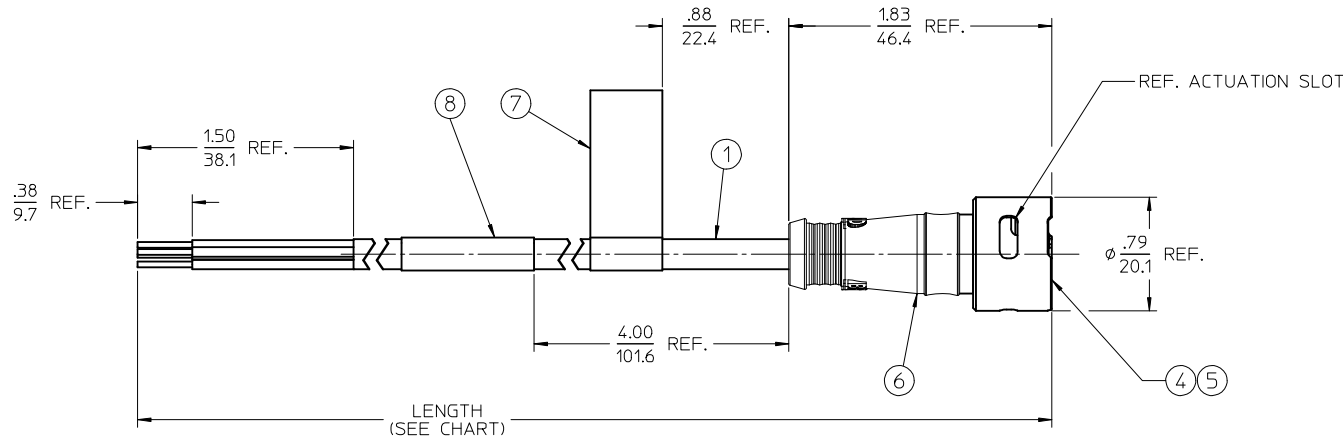
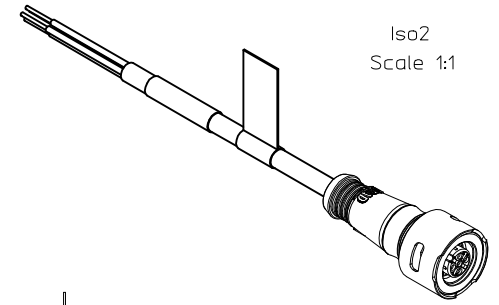

Ⓑ LW0X000C02MXXX

SINGLE END  
POLE QTY.  
HEAD STYLE  
CABLE TYPE  
FINISHED LENGTH  
REF. XXX = METERS  
EXAMPLE 010= 1M

- NOTES:
1. MATERIAL: SEE TABLE
  2. FINISHES: SEE TABLE
  3. PRODUCT SPECIFICATIONS: PS-120614-001
  4. CONTROL DOC: ES-120614-001
  5. 3 & 4 POLE ELECTRICAL SPECIFICATIONS:  
VOLTAGE RATING: 125V  
CURRENT RATING: 4 AMPS
  6. 5 POLE ELECTRICAL SPECIFICATIONS:  
VOLTAGE RATING: 32V  
CURRENT RATING: 4 AMPS

FEMALE FACE VIEW		
3 POLE	4 POLE	5 POLE
1 BROWN 2 NOT USED 3 BLUE 4 BLACK 5 NOT USED	1 BROWN 2 WHITE 3 BLUE 4 BLACK 5 NOT USED	1 BROWN 2 WHITE 3 BLUE 4 BLACK 5 GRAY

8	1	WRAP LABEL	PLASTIC FILM	BLACK/YELLOW
7	1	FLAG LABEL (WARNING)	POLYESTER	BLACK/ORANGE
6	1	OVERMOLD	TPE	YELLOW
5	1	OUTER SLEEVE	ST. STEEL	PASSIVATED
4	1	INNER SLEEVE	ST. STEEL	PASSIVATED
3	XX	CONTACT	Cu ALLOY	GOLD PLATED
2	1	INSERT	PUR	BLACK
1	1	CABLE, #18 AWG SJ00W	RUBBER	YELLOW
ITEM	QTY.	DESCRIPTION	MATERIAL	FINISH

ADDED P/N LEGEND	QUALITY SYMBOLS
EC NO: IPG2014-0138	▽=0
DRWINRSTONE 2013/07/23	▽=0
CHKD:B WOODMAN 2013/08/01	
APPR: BWOODMAN 2013/12/30	
DESCRIPTION	

GENERAL TOLERANCES (UNLESS SPECIFIED)	
mm	INCH
4 PLACES ± ---	± ---
3 PLACES ± ---	± ---
2 PLACES ± ---	± .01
1 PLACE ± 0.3	± ---
ANGULAR ± 2 °	

DRAFT WHERE APPLICABLE  
MUST REMAIN  
WITHIN DIMENSIONS

DIMENSION STYLE	
IN/MM	
DRAWN BY	DATE
RSTONE	2011/11/21
CHECKED BY	DATE
L. HARTMANN	2012/01/27
APPROVED BY	DATE
JFMURPHY	2012/04/18
MATERIAL NO.	DOCUMENT NO.
SEE CHART	SD-120614-015
SIZE	THIS DRAWING CONTAINS INFORMATION THAT IS PROPRIETARY TO MOLEX INCORPORATED AND SHOULD NOT BE USED WITHOUT WRITTEN PERMISSION

SCALE	DESIGN UNITS	THIRD ANGLE PROJECTION
1.5:1	INCH	
TITLE		
ULTRA-LOCK ZONE 2 FEMALE, STRAIGHT CO2, 18 AWG, SJ00W		
MOLEX INCORPORATED		
SHEET NO.	1 OF 1	

CLASS 1, DIVISION 2, GROUP A, B, C, OR D  
HAZARDOUS LOCATION

NON-HAZARDOUS LOCATION

CLASS 1, DIVISION 2, GROUP A, B, C, OR D  
HAZARDOUS LOCATION

NON-HAZARDOUS LOCATION

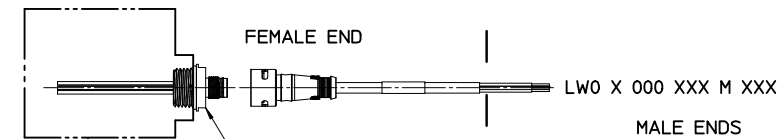

LWR X 006 A18 CXXX  
(MALE 1/2" NPT)  
LWR X A06 A18 CXXX  
(MALE 1/4" NPT)

LW0 X 000 XXX M XXX  
MALE ENDS

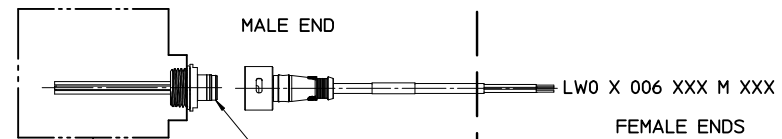
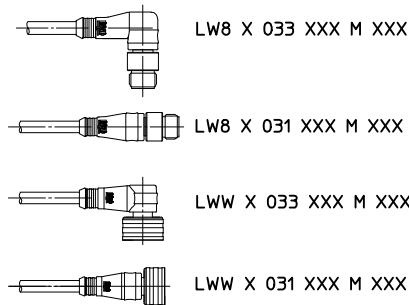
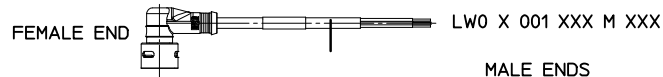
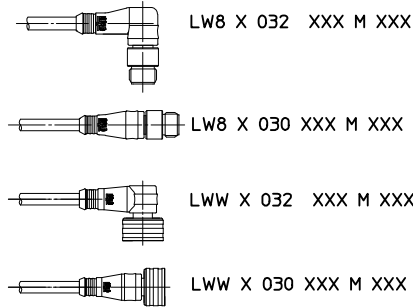

LWR X 000 A18 CXXX  
(FEMALE 1/2" NPT)  
LWR X A00 A18 CXXX  
(FEMALE 1/4" NPT)

LW0 X 006 XXX M XXX  
FEMALE ENDS

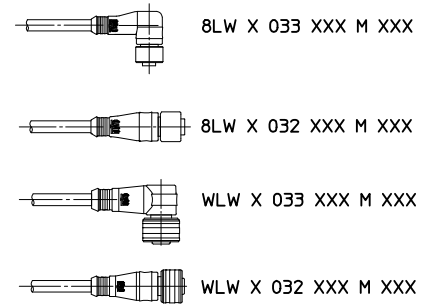
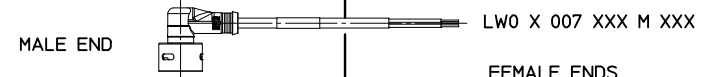
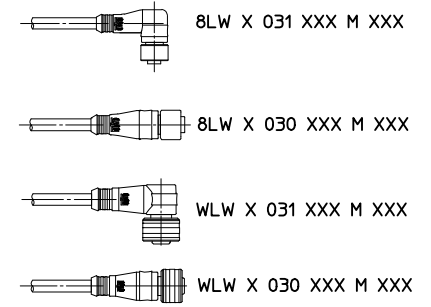

NOTES:

1. THE INSTALLATION MUST BE IN ACCORDANCE WITH THE NATIONAL ELECTRICAL CODE (NEC), ANSI/NFPA 70. SPECIFIC REQUIREMENTS FOR THE INSTALLATION OF ITC RATED CABLE MAY BE FOUND IN ARTICLE 501.4(B)(1)(5) AND ARTICLE 727.4
2. THE MOLDED CONSTRUCTION OF THE CORDSET AND GAS/VAPORTIGHT CONTINUOUS SHEATH OF THE CABLE MEET THE REQUIREMENTS OF THE NEC, ARTICLE 501-5(E)(2) FOR CABLE SEALS IN CLASS 1, DIVISION 2

FIELD DEVICE APPROVAL FOR CLASS 1, DIV. 2 OR CLASS 1, ZONE2 INSTALLATIONS

REF. SEE SHEET 3 FOR CONFIGURATION INFORMATION

NOTICE: THIS PART IS CSA AND FACTORY MUTUAL APPROVED  
NO CHANGES CAN BE MADE TO THE ASSEMBLY, COMPONENTS  
OR SUPPLIER WITHOUT PRIOR APPROVAL FROM CSA AND  
FACTORY MUTUAL.

THIS DRAWING SUPERSEDES ES-120614-001 REV-B

<p>SEE SHEET 3 EC NO: IPG2018-0141 DRAWN BY: DRWINRSTONE 2017/08/28 CHKD: BWOODMAN 2017/08/30 APPR: BWOODMAN 2017/09/06</p>	<p>QUALITY SYMBOLS ▽=0 ▽=0</p>	GENERAL TOLERANCES (UNLESS SPECIFIED)		DIMENSION STYLE IN/MM		SCALE 1:1	DESIGN UNITS INCH	THIRD ANGLE PROJECTION		
						TITLE CONTROL DOC FOR ULTRA-LOCK ZONE 2				
						DRAWN BY: RSTONE DATE: 2012/05/18				
						CHECKED BY: K JOZWIK DATE: 2012/05/22				
				APPROVED BY: JFMURPHY DATE: 2012/08/27		MATERIAL NO. 1206149999		DOCUMENT NO. SD-120614-999		
		DRAFT WHERE APPLICABLE MUST REMAIN WITHIN DIMENSIONS		SIZE C		THIS DRAWING CONTAINS INFORMATION THAT IS PROPRIETARY TO MOLEX INCORPORATED AND SHOULD NOT BE USED WITHOUT WRITTEN PERMISSION				

CLASS 1, DIVISION 2, GROUP A, B, C, OR D  
HAZARDOUS LOCATION

HAZARDOUS LOCATION

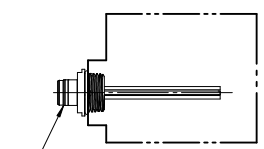
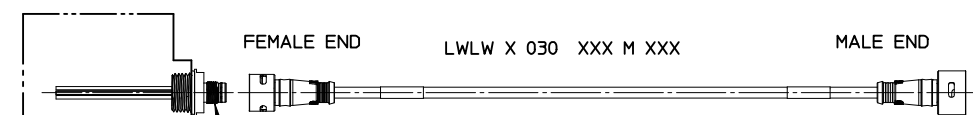

LWR X 006 A18 CXXX  
(MALE 1/2" NPT)

LWR X A06 A18 CXXX  
(MALE 1/4" NPT)

LWR X 000 A18 CXXX  
(FEMALE 1/2" NPT)

LWR X A00 A18 CXXX  
(FEMALE 1/4" NPT)

LWLW X 032 XXX M XXX

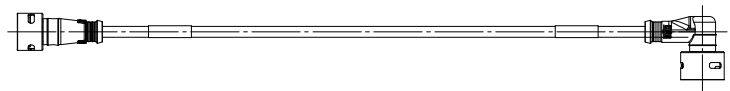

LWLW X 031 XXX M XXX

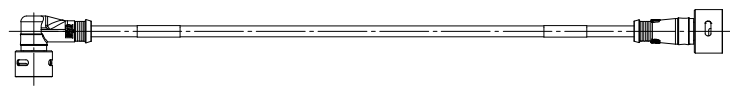

LWLW X 033 XXX M XXX

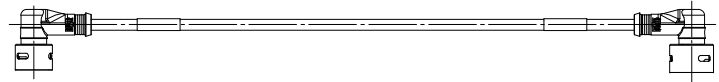

- REF:
1. SEE SHEET 1 FOR NOTES
  2. SEE SHEET 3 FOR CONFIGURATION INFORMATION

NOTICE: THIS PART IS CSA AND FACTORY MUTUAL APPROVED  
NO CHANGES CAN BE MADE TO THE ASSEMBLY, COMPONENTS  
OR SUPPLIER WITHOUT PRIOR APPROVAL FROM CSA AND  
FACTORY MUTUAL.

SEE SHEET 3 EC NO: JFG2018-0141 2017/08/28 DRAWNRSTONE CHKD:WOODMAN 2017/08/30 APPR:WOODMAN 2017/09/06	QUALITY SYMBOLS ▽=0 ▽=0	GENERAL TOLERANCES (UNLESS SPECIFIED)		DIMENSION STYLE IN/MM		SCALE 1:1	DESIGN UNITS INCH	THIRD ANGLE PROJECTION	
		4 PLACES ± --- ± --- 3 PLACES ± --- ± --- 2 PLACES ± --- ± --- 1 PLACE ± --- ± ---	mm INCH ± --- ± --- ± --- ± --- ± --- ± --- ± --- ± ---	DRAWN BY RSTONE	DATE 2012/05/18	TITLE CONTROL DOC FOR ULTRA-LOCK ZONE 2		MOLEX INCORPORATED	
DRAFT WHERE APPLICABLE MUST REMAIN WITHIN DIMENSIONS		CHECKED BY K JOZWIK	DATE 2012/05/22	APPROVED BY JFMURPHY		DATE 2012/08/27	MATERIAL NO. 1206149999		
THIS DRAWING CONTAINS INFORMATION THAT IS PROPRIETARY TO MOLEX INCORPORATED AND SHOULD NOT BE USED WITHOUT WRITTEN PERMISSION									

M12/MICROCHANGE ULTRA-LOCK CORD CONNECTORS AND CORD SETS

LWO 3 000 C02 M 020 8  
 I II III IV V VI VII

I: CONNECTOR TYPE

- LWO= ULTRA-LOCK ZONE 2 MALE OR FEMALE SINGLE END CORDSET
- LWW= ULTRA-LOCK ZONE 2 FEMALE TO STANDARD ULTRA-LOCK MALE DOUBLE ENDED CORDSET
- WLW= ULTRA-LOCK ZONE 2 MALE TO STANDARD ULTRA-LOCK FEMALE DOUBLE ENDED CORDSET
- LW8= ULTRA-LOCK ZONE 2 FEMALE TO STANDARD M12 MALE DOUBLE ENDED CORDSET
- 8LW= ULTRA-LOCK ZONE 2 MALE TO STANDARD M12 FEMALE DOUBLE ENDED CORDSET
- LWLW= ULTRA-LOCK ZONE 2 FEMALE TO ULTRA-LOCK ZONE 2 MALE DOUBLE ENDED CORDSET

II: NUMBER OF POLES: 3= 3 PIN, 4= 4 PIN, 5 = 5 PIN

III: CONFIGURATION

- SINGLE ENDED:  
 000= STRAIGHT FEMALE CONNECTOR  
 001= FEMALE 90°  
 006= STRAIGHT MALE, EXTERNAL THREAD  
 007= MALE 90°

DOUBLE ENDED:

- 030= STRAIGHT FEMALE CONNECTOR TO STRAIGHT MALE CONNECTOR
- 031= FEMALE 90° TO MALE STRAIGHT
- 032= FEMALE STRAIGHT TO MALE 90°
- 033= FEMALE 90° TO MALE 90°

IV: CABLE TYPE

- C02= SJ00W YELLOW, 18 AWG, DC CODE (CSA ONLY) **G**
- K03= PLTC/ITC, 18 AWG, TPE JACKET
- K05= PLTC/ITC, 22 AWG, TPE JACKET

V: UNIT OF MEASURE

- F= FEET
- M= METERS

VI: CABLE LENGTH (MAY BE ANY 3 DIGIT NUMBER FROM 001-100)

- 1ST DIGIT= 10 X LENGTH
- 2ND DIGIT= 1 X LENGTH
- 3RD DIGIT= .1 X LENGTH

VII: COUPLING NUT MATERIAL

ULTRA-LOCK ZONE 2 END(S) ARE STAINLESS STEEL

M12 OR ULTRA-LOCK:

- NONE = STANDARD MATERIAL (NICKEL PLATED BRASS)
- 8= STAINLESS STEEL

NOTICE: THIS PART IS CSA AND FACTORY MUTUAL APPROVED  
 NO CHANGES CAN BE MADE TO THE ASSEMBLY, COMPONENTS  
 OR SUPPLIER WITHOUT PRIOR APPROVAL FROM CSA AND  
 FACTORY MUTUAL.

M12/MICROCHANGE ULTRA-LOCK OUTLETS

LWR 3 A00 A18 M 020 8  
 I II III IV V VI VII

I: CONNECTOR TYPE

LWR= LOCKING INLETS AND OUTLETS

II: NUMBER OF POLES 3=3 PIN, 4= 4 PIN, & 5= 5 PIN

III: CONFIGURATION

- SINGLE ENDED:  
 A00= FEMALE STRAIGHT (INT.THEAD) 1/4-18 NPT  
 A06= MALE STRAIGHT (EXT.THEAD) 1/4-18 NPT  
 000= FEMALE STRAIGHT (INT.THEAD) 1/2-14 NPT  
 006= MALE STRAIGHT (EXT.THEAD) 1/2-14 NPT

**G** IV: WIRE TYPE

- A18= 22 AWG, PVC, DC COLOR CODE, UL TYPE 1061
- A16= 18 AWG, PVC, DC COLOR CODE, UL TYPE 1569

V: UNIT OF MEASURE

- A= INCHES
- F= FEET
- C= CENTIMETERS
- M= METERS

VI: WIRE LENGTH (MAY BE ANY 3 DIGIT NUMBER FROM 001-100)

- 1ST DIGIT= 10 X LENGTH
- 2ND DIGIT= 1 X LENGTH
- 3RD DIGIT= .1 X LENGTH

VII: SHELL MATERIAL

- M12 OR ULTRA-LOCK:
- NONE = STANDARD MATERIAL (COPPER ZINC ALLOY)
- 3= NICKEL PLATED BRASS
- 8= STAINLESS STEEL

CORSET NOTE IV, ADD CSA OUTLET NOTE IV, REMOVE PCB PINS EC NO: IPGZ018-0141 DR: MHRSTONE 2017/08/28 CHKD: BWOODMAN 2017/08/30 APPR: BWOODMAN 2017/09/06	QUALITY SYMBOLS ▽=0 ▽=0	GENERAL TOLERANCES (UNLESS SPECIFIED) mm INCH 4 PLACES ±--- ±--- 3 PLACES ±--- ±--- 2 PLACES ±--- ±--- 1 PLACE ±--- ±--- ANGULAR ±---°	DIMENSION STYLE IN/MM DRAWN BY DATE RSTONE 2012/05/18 CHECKED BY DATE K JOZWIK 2012/05/22 APPROVED BY DATE JFMURPHY 2012/08/27	SCALE 1:1	DESIGN UNITS INCH	THIRD ANGLE PROJECTION
	CONTROL DOC FOR ULTRA-LOCK ZONE 2					
	MOLEX INCORPORATED					
	DRAFT WHERE APPLICABLE MUST REMAIN WITHIN DIMENSIONS			MATERIAL NO. 1206149999	DOCUMENT NO. SD-120614-999	SHEET NO. 3 OF 3

CLASS 1, DIVISION 2, GROUP A, B, C, OR D  
HAZARDOUS LOCATION

NON-HAZARDOUS LOCATION

CLASS 1, DIVISION 2, GROUP A, B, C, OR D  
HAZARDOUS LOCATION

NON-HAZARDOUS LOCATION

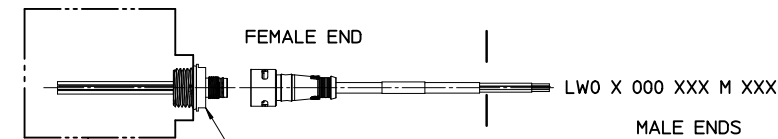

LWR X 006 A18 CXXX  
(MALE 1/2" NPT)  
LWR X A06 A18 CXXX  
(MALE 1/4" NPT)

LW0 X 000 XXX M XXX  
MALE ENDS

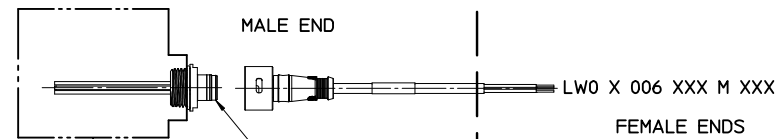
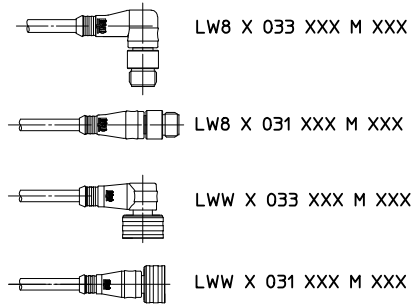
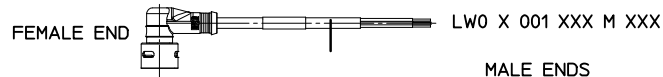
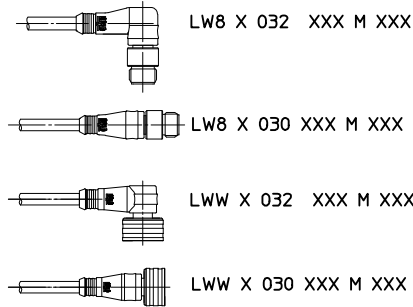

LWR X 000 A18 CXXX  
(FEMALE 1/2" NPT)  
LWR X A00 A18 CXXX  
(FEMALE 1/4" NPT)

LW0 X 006 XXX M XXX  
FEMALE ENDS

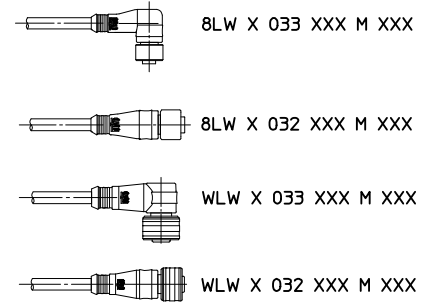
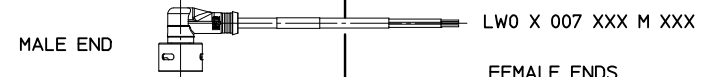
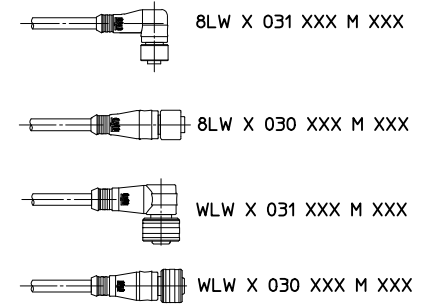

NOTICE: THIS PART IS CSA AND FACTORY MUTUAL APPROVED  
NO CHANGES CAN BE MADE TO THE ASSEMBLY, COMPONENTS  
OR SUPPLIER WITHOUT PRIOR APPROVAL FROM CSA AND  
FACTORY MUTUAL.

- NOTES:
1. THE INSTALLATION MUST BE IN ACCORDANCE WITH THE NATIONAL ELECTRICAL CODE (NEC), ANSI/NFPA 70. SPECIFIC REQUIREMENTS FOR THE INSTALLATION OF ITC RATED CABLE MAY BE FOUND IN ARTICLE 501.4(B)(1)(5) AND ARTICLE 727.4
  2. THE MOLDED CONSTRUCTION OF THE CORDSET AND GAS/VAPORTIGHT CONTINUOUS SHEATH OF THE CABLE MEET THE REQUIREMENTS OF THE NEC, ARTICLE 501-5(E)(2) FOR CABLE SEALS IN CLASS 1, DIVISION 2

FIELD DEVICE APPROVAL FOR CLASS 1, DIV. 2 OR CLASS 1, ZONE2 INSTALLATIONS

REF. SEE SHEET 3 FOR CONFIGURATION INFORMATION

THIS DRAWING SUPERSEDES ES-120614-001 REV-B

SEE SHEET 3 EC NO: IPG2018-0141 DRAWN BY: DRWINRSTONE 2017/08/28 CHKD: BWOODMAN 2017/08/30 APPR: BWOODMAN 2017/09/06	QUALITY SYMBOLS ▽=0 ▽=0	GENERAL TOLERANCES (UNLESS SPECIFIED)		DIMENSION STYLE IN/MM		SCALE 1:1	DESIGN UNITS INCH	THIRD ANGLE PROJECTION		
		4 PLACES ± --- ± ---	3 PLACES ± --- ± ---	2 PLACES ± --- ± ---	1 PLACE ± --- ± ---	ANGULAR ± ---°	DRAWN BY: RSTONE DATE: 2012/05/18	CHECKED BY: K JOZWIK DATE: 2012/05/22	APPROVED BY: JFMURPHY DATE: 2012/08/27	TITLE CONTROL DOC FOR ULTRA-LOCK ZONE 2
		DRAFT WHERE APPLICABLE MUST REMAIN WITHIN DIMENSIONS			MATERIAL NO. 1206149999	DOCUMENT NO. SD-120614-999	MOLEX INCORPORATED			SHEET NO. 1 OF 3
		THIS DRAWING CONTAINS INFORMATION THAT IS PROPRIETARY TO MOLEX INCORPORATED AND SHOULD NOT BE USED WITHOUT WRITTEN PERMISSION								

CLASS 1, DIVISION 2, GROUP A, B, C, OR D  
HAZARDOUS LOCATION

HAZARDOUS LOCATION

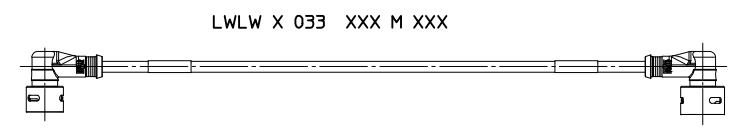
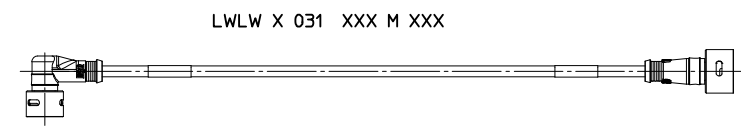
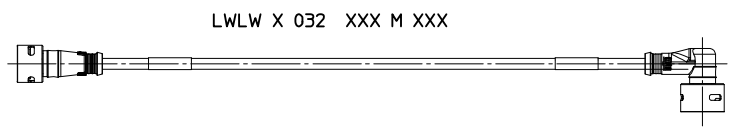
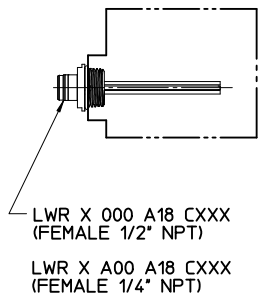
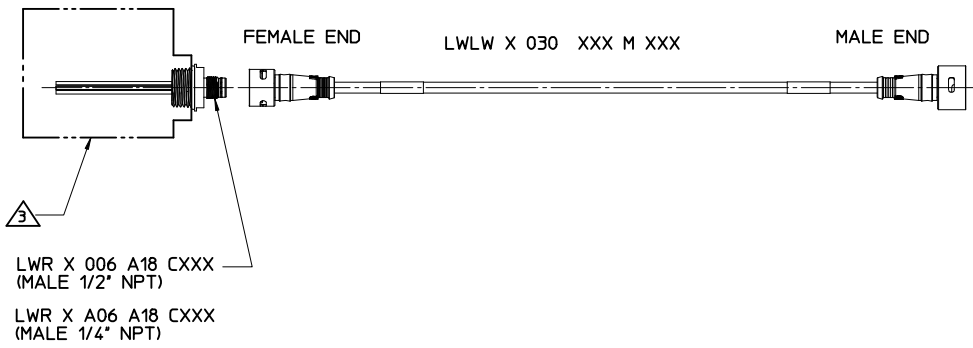

- REF:
1. SEE SHEET 1 FOR NOTES
  2. SEE SHEET 3 FOR CONFIGURATION INFORMATION

NOTICE: THIS PART IS CSA AND FACTORY MUTUAL APPROVED  
NO CHANGES CAN BE MADE TO THE ASSEMBLY, COMPONENTS  
OR SUPPLIER WITHOUT PRIOR APPROVAL FROM CSA AND  
FACTORY MUTUAL.

SEE SHEET 3 EC NO: JFG2018-0141 2017/08/28 DRAWNR:STONE 2017/08/30 CHKD:WOODMAN 2017/09/06 APPR:WOODMAN	QUALITY SYMBOLS ▽=0 ▽=0	GENERAL TOLERANCES (UNLESS SPECIFIED)		DIMENSION STYLE IN/MM		SCALE 1:1	DESIGN UNITS INCH	THIRD ANGLE PROJECTION	
		4 PLACES ± --- ± --- 3 PLACES ± --- ± --- 2 PLACES ± --- ± --- 1 PLACE ± --- ± --- ANGULAR ± ---°	mm INCH ± --- ± --- ± --- ± --- ± --- ± --- ± --- ± ---	DRAWN BY RSTONE DATE 2012/05/18	CHECKED BY K JOZWIK DATE 2012/05/22	TITLE CONTROL DOC FOR ULTRA-LOCK ZONE 2		MOLEX INCORPORATED	
REV	DESCRIPTION	MATERIAL NO. 1206149999		DOCUMENT NO. SD-120614-999		SHEET NO. 2 OF 3		THIS DRAWING CONTAINS INFORMATION THAT IS PROPRIETARY TO MOLEX INCORPORATED AND SHOULD NOT BE USED WITHOUT WRITTEN PERMISSION	

M12/MICROCHANGE ULTRA-LOCK CORD CONNECTORS AND CORD SETS

LWO 3 000 C02 M 020 8  
 I II III IV V VI VII

I: CONNECTOR TYPE

- LWO= ULTRA-LOCK ZONE 2 MALE OR FEMALE SINGLE END CORDSET
- LWW= ULTRA-LOCK ZONE 2 FEMALE TO STANDARD ULTRA-LOCK MALE DOUBLE ENDED CORDSET
- WLW= ULTRA-LOCK ZONE 2 MALE TO STANDARD ULTRA-LOCK FEMALE DOUBLE ENDED CORDSET
- LW8= ULTRA-LOCK ZONE 2 FEMALE TO STANDARD M12 MALE DOUBLE ENDED CORDSET
- 8LW= ULTRA-LOCK ZONE 2 MALE TO STANDARD M12 FEMALE DOUBLE ENDED CORDSET
- LWLW= ULTRA-LOCK ZONE 2 FEMALE TO ULTRA-LOCK ZONE 2 MALE DOUBLE ENDED CORDSET

II: NUMBER OF POLES: 3= 3 PIN, 4= 4 PIN, 5 = 5 PIN

III: CONFIGURATION

- SINGLE ENDED:  
 000= STRAIGHT FEMALE CONNECTOR  
 001= FEMALE 90°  
 006= STRAIGHT MALE, EXTERNAL THREAD  
 007= MALE 90°

DOUBLE ENDED:

- 030= STRAIGHT FEMALE CONNECTOR TO STRAIGHT MALE CONNECTOR
- 031= FEMALE 90° TO MALE STRAIGHT
- 032= FEMALE STRAIGHT TO MALE 90°
- 033= FEMALE 90° TO MALE 90°

IV: CABLE TYPE

- C02= SJ00W YELLOW, 18 AWG, DC CODE (CSA ONLY) **G**
- K03= PLTC/ITC, 18 AWG, TPE JACKET
- K05= PLTC/ITC, 22 AWG, TPE JACKET

V: UNIT OF MEASURE

- F= FEET
- M= METERS

VI: CABLE LENGTH (MAY BE ANY 3 DIGIT NUMBER FROM 001-100)

- 1ST DIGIT= 10 X LENGTH
- 2ND DIGIT= 1 X LENGTH
- 3RD DIGIT= .1 X LENGTH

VII: COUPLING NUT MATERIAL

ULTRA-LOCK ZONE 2 END(S) ARE STAINLESS STEEL

M12 OR ULTRA-LOCK:

- NONE = STANDARD MATERIAL (NICKEL PLATED BRASS)
- 8= STAINLESS STEEL

NOTICE: THIS PART IS CSA AND FACTORY MUTUAL APPROVED  
 NO CHANGES CAN BE MADE TO THE ASSEMBLY, COMPONENTS  
 OR SUPPLIER WITHOUT PRIOR APPROVAL FROM CSA AND  
 FACTORY MUTUAL.

M12/MICROCHANGE ULTRA-LOCK OUTLETS

LWR 3 A00 A18 M 020 8  
 I II III IV V VI VII

I: CONNECTOR TYPE

LWR= LOCKING INLETS AND OUTLETS

II: NUMBER OF POLES 3=3 PIN, 4= 4 PIN, & 5= 5 PIN

III: CONFIGURATION

- SINGLE ENDED:  
 A00= FEMALE STRAIGHT (INT.THEAD) 1/4-18 NPT  
 A06= MALE STRAIGHT (EXT.THEAD) 1/4-18 NPT  
 000= FEMALE STRAIGHT (INT.THEAD) 1/2-14 NPT  
 006= MALE STRAIGHT (EXT.THEAD) 1/2-14 NPT

**G** IV: WIRE TYPE

- A18= 22 AWG, PVC, DC COLOR CODE, UL TYPE 1061
- A16= 18 AWG, PVC, DC COLOR CODE, UL TYPE 1569

V: UNIT OF MEASURE

- A= INCHES
- F= FEET
- C= CENTIMETERS
- M= METERS

VI: WIRE LENGTH (MAY BE ANY 3 DIGIT NUMBER FROM 001-100)

- 1ST DIGIT= 10 X LENGTH
- 2ND DIGIT= 1 X LENGTH
- 3RD DIGIT= .1 X LENGTH

VII: SHELL MATERIAL

- M12 OR ULTRA-LOCK:
- NONE = STANDARD MATERIAL (COPPER ZINC ALLOY)
- 3= NICKEL PLATED BRASS
- 8= STAINLESS STEEL

CORSET NOTE IV, ADD CSA OUTLET NOTE IV, REMOVE PCB PINS EC NO: IPG2018-0141 DR: DRWHRSTONE 2017/08/28 CHKD: BWOODMAN 2017/08/30 APPR: BWOODMAN 2017/09/06	QUALITY SYMBOLS	GENERAL TOLERANCES (UNLESS SPECIFIED)	DIMENSION STYLE	SCALE	DESIGN UNITS	THIRD ANGLE PROJECTION
	▽=0 ▽=0	mm	IN/MM	1:1	INCH	CONTROL DOC FOR ULTRA-LOCK ZONE 2
		INCH	IN/MM	1:1	INCH	
	DESCRIPTION	4 PLACES ±--- ±--- 3 PLACES ±--- ±--- 2 PLACES ±--- ±--- 1 PLACE ±--- ±--- ANGULAR ±---°	DRAWN BY DATE RSTONE 2012/05/18 CHECKED BY DATE K JOZWIK 2012/05/22 APPROVED BY DATE JFMURPHY 2012/08/27	MATERIAL NO. 1206149999	DOCUMENT NO. SD-120614-999	SHEET NO. 3 OF 3
REV	DRAFT WHERE APPLICABLE MUST REMAIN WITHIN DIMENSIONS	SIZE B	THIS DRAWING CONTAINS INFORMATION THAT IS PROPRIETARY TO MOLEX INCORPORATED AND SHOULD NOT BE USED WITHOUT WRITTEN PERMISSION			