

SECTION "A-A"  
TERMINAL ORIENTATION

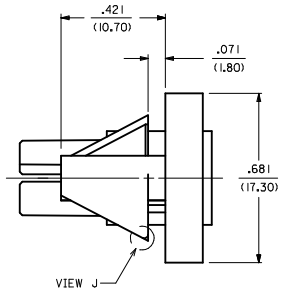

THIS AREA CAN BE SHARP OR RADIUS

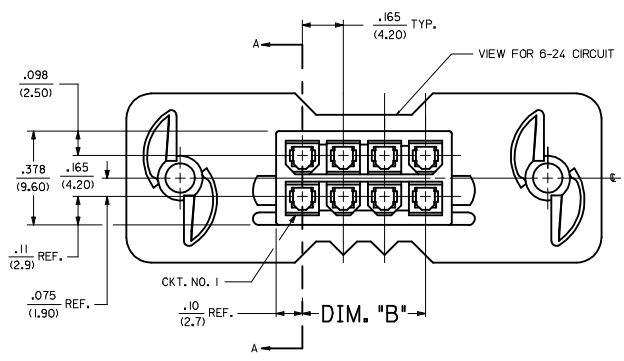
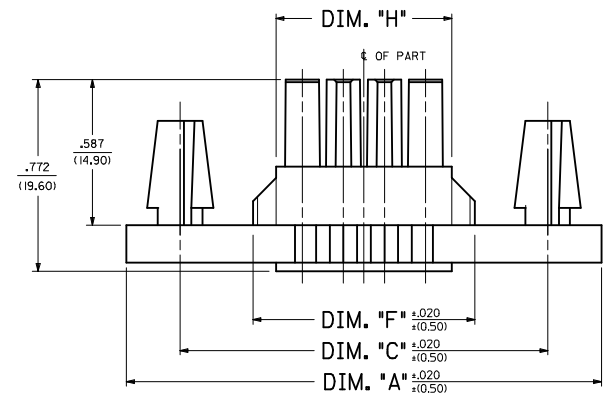
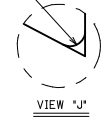

2-8 & 12-24 CIRCUIT HEADER  
(SEE SHEET 2 FOR 10 CIRCUIT HEADER DESIGN)

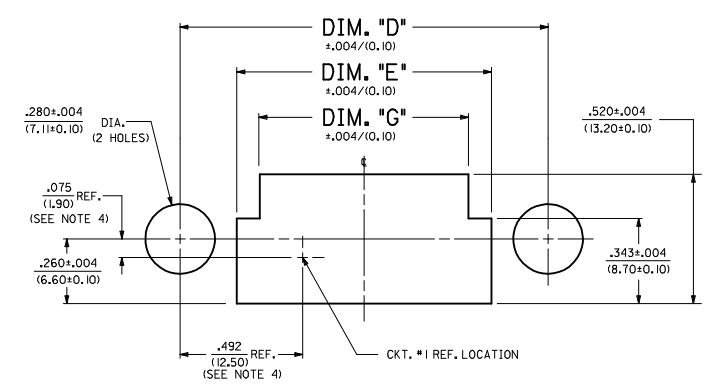

RECOMMENDED PANEL CUT-OUT FOR .050±.012/(.127±0.30) THICK PANEL  
(SEE NOTE 11)

LEGEND:  
42474 - \* \* \* 1  
BASE NUMBER  
CIRCUIT SIZE (02-24)  
MATERIAL (SEE NOTE 1.)

CKT. SIZE	DIM. 'A'	DIM. 'B'	DIM. 'C'	DIM. 'D'	DIM. 'E'	DIM. 'F'	DIM. 'G'	DIM. 'H'
2	1.417 (36.00)	N/A	.984 (25.00)	.984 (25.00)	.528 (13.40)	.398 (10.10)	.343 (8.70)	.213 (5.40)
4	1.583 (40.20)	.165 (4.20)	1.150 (29.20)	1.150 (29.20)	.693 (17.60)	.563 (14.30)	.508 (12.90)	.378 (9.60)
6	1.748 (44.40)	.331 (8.40)	1.315 (33.40)	1.315 (33.40)	1.199 (30.20)	.798 (20.10)	.673 (17.10)	.443 (11.30)
8	1.913 (48.60)	.496 (12.60)	1.480 (37.60)	1.480 (37.60)	1.402 (35.60)	.894 (22.70)	.839 (21.30)	.709 (18.00)
10	2.078 (52.80)	.661 (16.80)	1.645 (41.80)	1.645 (41.80)	1.891 (47.80)	1.059 (26.90)	1.004 (25.50)	.874 (22.20)
12	2.244 (57.00)	.827 (21.00)	1.811 (46.00)	1.811 (46.00)	2.142 (54.40)	1.224 (31.10)	1.169 (29.70)	1.039 (26.40)
14	2.409 (61.20)	.992 (25.20)	1.976 (50.20)	1.976 (50.20)	2.307 (58.60)	1.390 (35.30)	1.335 (33.90)	1.205 (30.60)
16	2.575 (65.40)	1.157 (29.40)	2.142 (54.40)	2.142 (54.40)	2.462 (62.80)	1.565 (39.50)	1.500 (38.10)	1.370 (34.80)
18	2.740 (69.60)	1.323 (33.60)	2.307 (58.60)	2.307 (58.60)	2.617 (66.90)	1.720 (43.70)	1.665 (42.30)	1.535 (39.00)
20	2.906 (73.80)	1.488 (37.80)	2.472 (62.80)	2.472 (62.80)	2.772 (70.90)	1.886 (47.80)	1.831 (46.50)	1.701 (43.20)
22	3.071 (78.00)	1.653 (42.00)	2.638 (67.00)	2.638 (67.00)	2.927 (74.70)	2.051 (52.10)	1.996 (50.70)	1.866 (47.40)
24	3.236 (82.20)	1.819 (46.20)	2.803 (71.20)	2.803 (71.20)	3.117 (79.10)	2.217 (56.30)	2.161 (54.90)	2.031 (51.60)

NOTES:

- MATERIAL:  
\*P = NYLON 6/6, 94V-2, COLOR: NATURAL.  
\*2 = NYLON 6/6, 94V-0, COLOR: NATURAL.  
\*3 = NYLON 6/6, 94V-2, COLOR: BLACK.  
\*4 = NYLON 6/6, 94V-0, COLOR: BLACK.
- FINISH: NOT APPLICABLE.
- PRODUCT SPECIFICATION: PS-5556-002
- PACKAGING: PK-42474-001
- PART MATES WITH MINI-FIT B.M.I. PLUG \*42475, AND HEADERS 42404, 42440, 43810, 44068 & 43879.
- PART TO BE USED WITH MOLEX FEMALE TERMINAL #5556.
- THIS CONNECTOR ALLOWS FOR .050/(1.27) MAX. MISALIGNMENT IN ANY DIRECTION.
- THIS DIMENSION TO BE USED FOR ALIGNMENT OF THE MATING CONNECTOR.
- CONNECTOR ASSEMBLIES ARE NOT TO BE MATED OR UNMATED WHILE CIRCUITS ARE LIVE.
- THIS PART IS INTENDED FOR ONE PANEL INSERTION ONLY, REMOVAL AND RE-INSERTION CAN DAMAGE THE MOUNTING SPIRALS.
- PANEL SHOULD BE PUNCHED IN THE DIRECTION OF CONNECTOR INSERTION.
- BOTH SPIRALS SHOULD BE INSERTED INTO THE PANEL AT THE SAME TIME, ROCKING THE PART INTO PLACE MAY CAUSE SPIRAL DAMAGE.
- THIS PART IS NOT INTENDED TO PROVIDE ANY ALIGNMENT OF CUSTOMER COMPONENTS OR MODULES, SUCH AS POWER SUPPLIES AND CHASSIS.
- IF THIS PRODUCT IS STORED IN AN ENVIRONMENT WITH A RELATIVE HUMIDITY OF LESS THAN 50%, MOISTURE MUST BE ADDED.  
REFER TO TECHNICAL ADVISORY AS-45499-001 FOR INSTRUCTIONS.
- A MAXIMUM TOLERANCE OF .050/(1.27) ALLOWS FOR 2 POINTS OF ELECTRICAL CONTACT.  
A MAXIMUM TOLERANCE OF .020/(.51) ALLOWS FOR 4 POINTS OF CONTACT.
- WIRES ARE TO BE DRESSED IN SUCH A MANNER TO ALLOW THE TERMINALS TO FLOAT FREELY IN THE POCKET.
- PART CONFORMS TO CLASS 'B' REQUIREMENTS OF COSMETIC SPECIFICATION PS-45499-002.

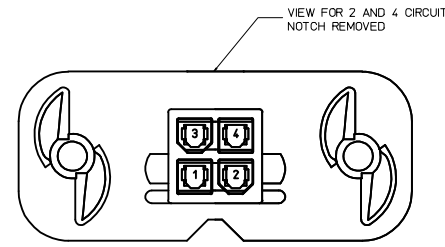

ADD'G ±.020 (±0.50) ELEC. NO. UCP2009-1790 DRAWN BY: 2009/01/28 CHYK: 2009/01/28 APPROV: FSWITH APPR: FSWITH	QUALITY SYMBOLS ▽=0 ▽=0	GENERAL TOLERANCES (UNLESS SPECIFIED) 4 PLACES ±.015 3 PLACES ±.015 2 PLACES ±.038 1 PLACE ±.076 ANGULAR ±1/2°	DIMENSION STYLE IN/MM	SCALE 1:1	DESIGN UNITS METRIC	THIRD ANGLE PROJECTION	
	DRAWN BY: GEP DATE: 1989/08/24	CHECKED BY: R/JF DATE: 1989/08/24	APPROVED BY: RAS DATE: 1989/08/24	MATERIAL NO. SEE SHEET 2	DOCUMENT NO. SD-42474-****	SHEET NO. 1 OF 2	TITLE PANEL-MOUNT RECEPTACLE BLIND MATE MINI-FIT JR. SERIES
	DRAFT WHERE APPLICABLE MUST REMAIN WITHIN DIMENSIONS						
	THIS DRAWING CONTAINS INFORMATION THAT IS PROPRIETARY TO MOLEX INCORPORATED AND SHOULD NOT BE USED WITHOUT WRITTEN PERMISSION						

	13	12	11	10	9	8	7	6	5	4	3	2	1	
	PART NUMBER	ENG. NUMBER	CKT. SIZE	MATERIAL (SEE NOTE 1.)	PART NUMBER	ENG. NUMBER	CKT. SIZE	MATERIAL (SEE NOTE 1.)	ITEM NUMBER	CKT. SIZE	MATERIAL (SEE NOTE 1.)	ITEM NUMBER	CKT. SIZE	MATERIAL (SEE NOTE 1.)
J	NOT TOOLED	42474-0211	2	94V-2	NOT TOOLED	42474-0221	2	94V-0	NOT TOOLED	2	94V-2	NOT TOOLED	2	94V-0
	15-06-0040	42474-0411	4	94V-2	15-06-0041	42474-0421	4	94V-0	42474-0431	4	94V-2	42474-0441	4	94V-0
	15-06-0060	42474-0611	6	94V-2	15-06-0061	42474-0621	6	94V-0	42474-0631	6	94V-2	42474-0641	6	94V-0
	15-06-0080	42474-0811	8	94V-2	15-06-0081	42474-0821	8	94V-0	42474-0831	8	94V-2	NOT TOOLED	8	94V-0
I	15-06-0100	42474-1011	10	94V-2	15-06-0101	42474-1021	10	94V-0	42474-1031	10	94V-2	42474-1041	10	94V-0
	NOT TOOLED	42474-1211	12	94V-2	NOT TOOLED	42474-1221	12	94V-0	NOT TOOLED	12	94V-2	NOT TOOLED	12	94V-0
	15-06-0140	42474-1411	14	94V-2	15-06-0141	42474-1421	14	94V-0	42474-1431	14	94V-2	42474-1441	14	94V-0
	NOT TOOLED	42474-1611	16	94V-2	NOT TOOLED	42474-1621	16	94V-0	NOT TOOLED	16	94V-2	NOT TOOLED	16	94V-0
H	15-06-0180	42474-1811	18	94V-2	15-06-0181	42474-1821	18	94V-0	42474-1831	18	94V-2	42474-1841	18	94V-0
	NOT TOOLED	42474-2011	20	94V-2	NOT TOOLED	42474-2021	20	94V-0	NOT TOOLED	20	94V-2	NOT TOOLED	20	94V-0
	NOT TOOLED	42474-2211	22	94V-2	NOT TOOLED	42474-2221	22	94V-0	NOT TOOLED	22	94V-2	NOT TOOLED	22	94V-0
	15-06-0240	42474-2411	24	94V-2	15-06-0241	42474-2421	24	94V-0	42474-2431	24	94V-2	42474-2441	24	94V-0

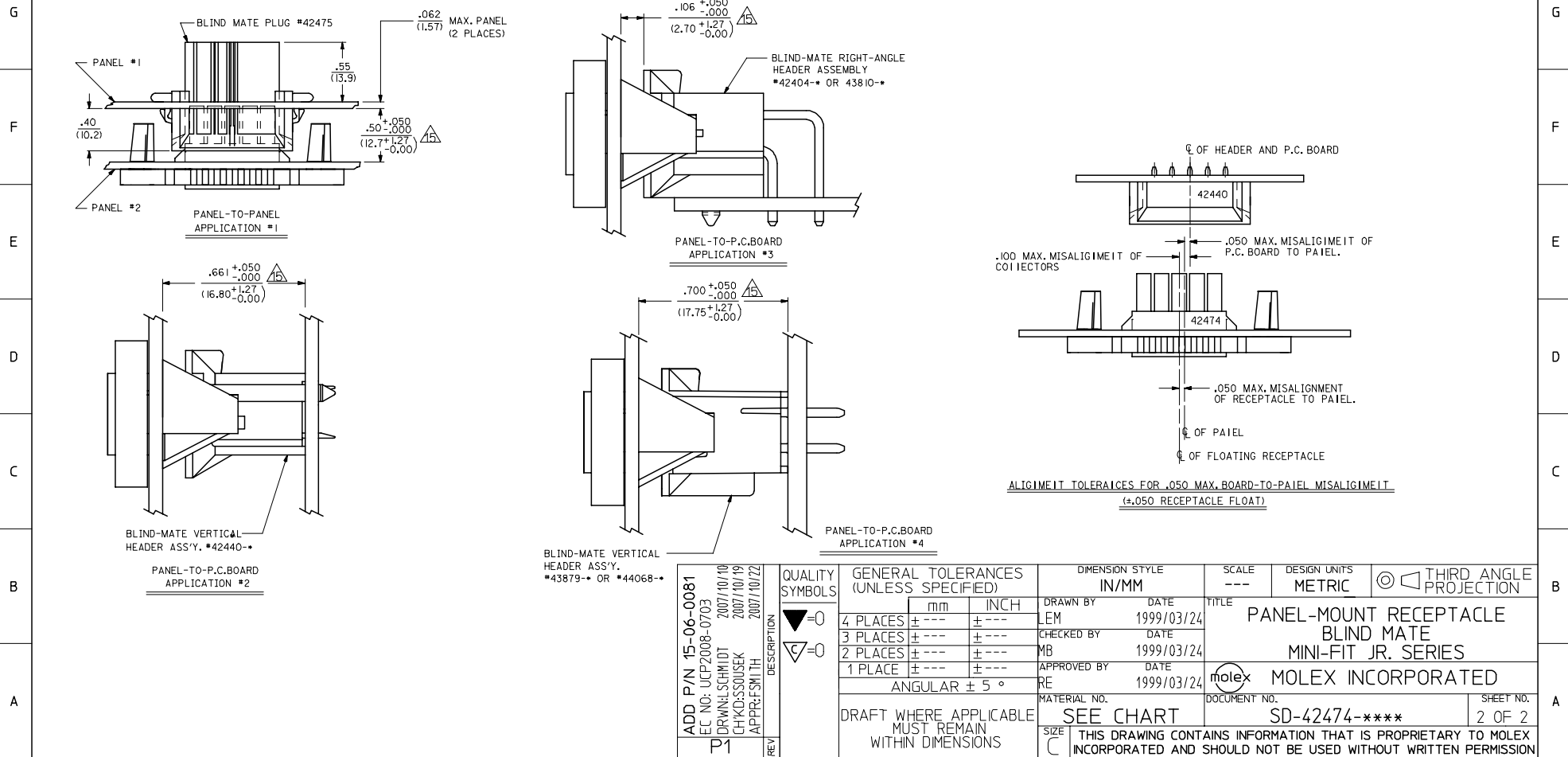

ADD P/N 15-06-0081 FC NO: UCP2008-0703 DRW: LSC/HD CHKD: SSOUSEK APPR: FSM/TH P1	QUALITY SYMBOLS =0 =0	GENERAL TOLERANCES (UNLESS SPECIFIED) mm INCH 4 PLACES ± .005 ± .005 3 PLACES ± .005 ± .005 2 PLACES ± .005 ± .005 1 PLACE ± .005 ± .005 ANGULAR ± 5 °	DIMENSION STYLE IN/MM		SCALE ---	DESIGN UNITS METRIC	THIRD ANGLE PROJECTION
			DRAWN BY LEM	DATE 1999/03/24	TITLE PANEL-MOUNT RECEPTACLE BLIND MATE MINI-FIT JR. SERIES	MOLEX INCORPORATED	
DRAFT WHERE APPLICABLE MUST REMAIN WITHIN DIMENSIONS			MATERIAL NO. SEE CHART		DOCUMENT NO. SD-42474-****		SHEET NO. 2 OF 2
THIS DRAWING CONTAINS INFORMATION THAT IS PROPRIETARY TO MOLEX INCORPORATED AND SHOULD NOT BE USED WITHOUT WRITTEN PERMISSION							