

Distributed by:

JAMECO[®]
ELECTRONICS

www.Jameco.com ♦ 1-800-831-4242

The content and copyrights of the attached
material are the property of its owner.

Jameco Part Number 878462

FEATURES AND SPECIFICATIONS

Features and Benefits

- Sizes 1 to 25 circuits
- 6471 is end-to-end stackable (2 housings only)
- 2695 version with or without locking ramp and polarizing ribs

Reference Information

Product Specification: PS-10-07

Packaging: Bag

UL File No.: E29179

CSA File No.: LR19980

Mates With: Molex KK 2.54mm (.100") pitch headers and 0.04mm (.025") pins

Use With: 2695—2759, 6459 or 41572 terminals

6471—4809 terminals

Designed In: Inches

Electrical*

Voltage: 250V

Current: Phosphor Bronze—4.0A max.

Brass—2.5A max.

Contact Resistance: 20mΩ max.

Dielectric Withstanding Voltage: 1500V AC

Insulation Resistance: 50K MΩ min.

Mechanical*

Contact Insertion Force: 681g (1.5 lb) max.

Contact Retention to Housing: 3.63kg (8 lb) min.

Mating Force: 199g max.

Unmating Force: 57g min.

Normal Force: 200g min.

Physical

Housing: 2695—White nylon, UL 94V-0

6471—White nylon, UL 94V-0

Operating Temperature: 0 to +75 °C

molex® 2.54mm (.100") Pitch KK® Crimp Terminal Housing

2695/6471

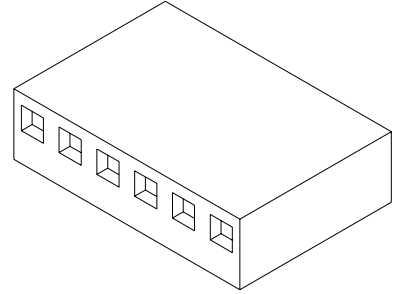

2.54mm (.100") Pitch

CATALOG DRAWING (FOR REFERENCE ONLY)

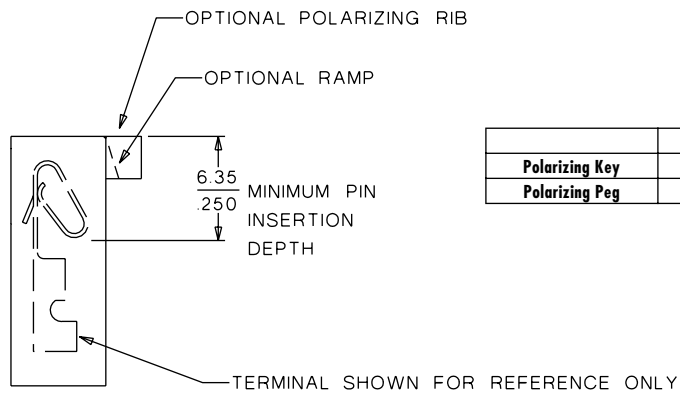
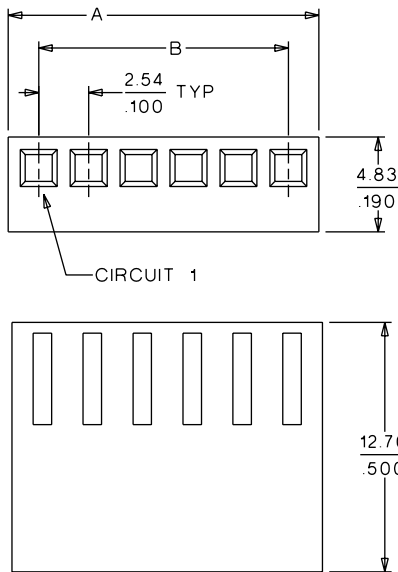

Note: When mating polarizing rib version with breakaway friction lock header or polarizing wall series, the end friction lock or polarizing wall of header must be removed.

	Order No.
Polarizing Key	15-04-9209
Polarizing Peg	15-04-9210

Note: 2695 shown

ORDERING INFORMATION AND DIMENSIONS

Circuits	Order No.				Dimension	
	2695		6471		A	B
	With Locking Ramp	With Locking Ramp and Polarizing Ribs	Without Locking Ramp or Ribs	With Locking Ramp and Polarizing Ribs†		
1			• 22-01-2011		3.10 (.122)	
2	• 22-01-2027	• 22-01-3027	• 22-01-2021	22-01-2025	5.60 (.220)	2.54 (.100)
3	• 22-01-2037	• 22-01-3037	• 22-01-2031	22-01-2035	8.10 (.320)	5.08 (.200)
4	• 22-01-2047	• 22-01-3047	• 22-01-2041	22-01-2045	10.70 (.420)	7.62 (.300)
5	• 22-01-2057	• 22-01-3057	• 22-01-2051	22-01-2055	13.20 (.520)	10.16 (.400)
6	• 22-01-2067	• 22-01-3067	• 22-01-2061	22-01-2065	15.80 (.620)	12.70 (.500)
7	• 22-01-2077	• 22-01-3077	• 22-01-2071	22-01-2075	18.30 (.720)	15.24 (.600)
8	• 22-01-2087	• 22-01-3087	• 22-01-2081	22-01-2085	20.90 (.820)	17.78 (.700)
9	• 22-01-2097	• 22-01-3097	• 22-01-2091	22-01-2095	23.40 (.920)	20.32 (.800)
10	• 22-01-2107	• 22-01-3107	• 22-01-2101	22-01-2105	25.90 (1.020)	22.86 (.900)
11	• 22-01-2117	• 22-01-3117	• 22-01-2111	22-01-2115	28.50 (1.120)	25.40 (1.000)
12	• 22-01-2127	• 22-01-3127	• 22-01-2121	22-01-2125	31.00 (1.220)	27.94 (1.100)

Circuits	Order No.				Dimension	
	2695		6471		A	B
	With Locking Ramp	With Locking Ramp and Polarizing Ribs	Without Locking Ramp or Ribs	With Locking Ramp and Polarizing Ribs†		
13	• 22-01-2137	• 22-01-3137	• 22-01-2131	22-01-2135	33.50 (1.320)	30.48 (1.200)
14	• 22-01-2147	• 22-01-3147	• 22-01-2141	22-01-2145	36.10 (1.420)	33.02 (1.300)
15	• 22-01-2157	• 22-01-3157	• 22-01-2151	22-01-2155	38.60 (1.520)	35.56 (1.400)
16	• 22-01-2167	• 22-01-3167	• 22-01-2161	22-01-2165	41.20 (1.620)	38.10 (1.500)
17	• 22-01-2177	• 22-01-3177	• 22-01-2171	22-01-2175	43.70 (1.720)	40.64 (1.600)
18	• 22-01-2187	• 22-01-3187	• 22-01-2181	22-01-2185	46.20 (1.820)	43.18 (1.700)
19	• 22-01-2197	• 22-01-3197	• 22-01-2191		48.80 (1.920)	45.72 (1.800)
20	• 22-01-2207	• 22-01-3207	• 22-01-2201		51.30 (2.020)	48.26 (1.900)
21	• 22-01-2217	• 22-01-3217	• 22-01-2211		53.90 (2.120)	50.80 (2.000)
22	• 22-01-2227	• 22-01-3227	• 22-01-2221		56.40 (2.220)	53.34 (2.100)
23	• 22-01-2237	• 22-01-3237	• 22-01-2231		58.90 (2.320)	55.88 (2.200)
24	• 22-01-2247	• 22-01-3247	• 22-01-2241		61.50 (2.420)	58.42 (2.300)
25	• 22-01-2257	• 22-01-3257	• 22-01-2251		64.00 (2.520)	60.96 (2.400)

* US Standard Product, available through Molex franchised distributors

* When mated with Molex product only

† For circuits 19-28, contact Molex



PRODUCT SPECIFICATION

1.0 SCOPE

This Product Specification covers the following

- A. 2.50 mm centerline (pitch) 0.64 mm square pin headers
- B. 2.54 mm centerline (pitch) 0.64 mm square pin headers

when mated with either printed circuit board (PCB) connectors or connectors terminated with 22 to 28 AWG wire using crimp technology.

2.0 PRODUCT DESCRIPTION

2.1 PRODUCT NAME AND SERIES NUMBERS

Crimp Terminals: 4809, 2759, 41572, 6459, 40445, 8088

Crimp Housings: 2695, 5051, 6471

PCB Connectors: 7534, 4455

Headers: 3022, 3202, 3094, 3494, 6410, 7930, 7395, 90578

Wire to board connector : 7690

Other products conforming to this specification are noted on the individual drawings.

2.2 DIMENSIONS, MATERIALS, PLATINGS AND MARKINGS

Terminal Material: Brass or Phos. Bronze (for Max performance use phos bronze material.)

Housing: Nylon or Polyester

Pins: Brass or Phos. Bronze

For more information on dimensions, materials, and plating see the individual drawings.

2.3 SAFETY AGENCY APPROVALS

UL File Number E29179

CSALR19980

3.0 APPLICABLE DOCUMENTS AND SPECIFICATIONS

None

4.0 RATINGS

4.1 VOLTAGE

250 Volts

4.2 CURRENT AND APPLICABLE WIRES (Current is dependent on connector size, contact material, plating, ambient temperature, printed circuit board characteristics and related factors. Actual current rating is application dependent and should be evaluated for each application.)

AWG	Amps (Max)	Outside Insulation Diameter
22	4.00	See Drawings
24	3.75	See Drawings
26	3.50	See Drawings
28	3.00	See Drawings

4.3 TEMPERATURE (ambient + 30° temp rise)

Operating: 0°C to +75°C

Non-operating: - 40°C to +105°C

REVISION:	ECR/ECN INFORMATION:	TITLE:	SHEET No.	
A	EC No: E2003 -0971 DATE: 2003 / 03 / 18	PRODUCT SPECIFICATION 2.50mm & 2.54mm CENTER KK CONNECTORS	1 of 5	
DOCUMENT NUMBER:	CREATED / REVISED BY:	CHECKED BY:	APPROVED BY:	
PS-99020-0088	B MAGUIRE	L Kiernan	M Wilhite	



PRODUCT SPECIFICATION

5.0 PERFORMANCE

5.1 ELECTRICAL REQUIREMENTS

DESCRIPTION	TEST CONDITION	REQUIREMENT
Contact Resistance (Low Level)	Mate connectors: apply a maximum voltage of 20 mV and a current of 100 mA.	10 milliohms MAXIMUM [initial]
Contact Resistance of Wire Termination (Low Level)	Terminate the applicable wire to the terminal and measure wire using a voltage of 20 mV and a current of 100 mA.	2 milliohms MAXIMUM [initial]
Insulation Resistance	Unmate & unmount connectors: apply a voltage of 500 VDC between adjacent terminals and between terminals to ground.	1000 Megaohms MINIMUM
Dielectric Withstanding Voltage	Unmate connectors: apply a voltage of {two times the rated voltage plus 1000 volts} VAC for 1 minute between adjacent terminals and between terminals to ground.	No breakdown
Capacitance	Measure between adjacent terminals at 1 MHz.	2 picofarads MAXIMUM
Temperature Rise (via Current Cycling)	Mate connectors: measure the temperature rise at the rated current after: 1) 96 hours (steady state) 2) 240 hours (45 minutes ON and 15 minutes OFF per hour) 3) 96 hours (steady state)	Temperature rise: +30°C MAXIMUM

REVISION: A	ECR/ECN INFORMATION: EC No: E2003 -0971 DATE: 2003 / 03 / 18	TITLE: PRODUCT SPECIFICATION 2.50mm & 2.54mm CENTER KK CONNECTORS	SHEET No. 2 of 5
DOCUMENT NUMBER: PS-99020-0088	CREATED / REVISED BY: B MAGUIRE	CHECKED BY: L Kiernan	APPROVED BY: M Wilhite



PRODUCT SPECIFICATION

5.2 MECHANICAL REQUIREMENTS

DESCRIPTION	TEST CONDITION	REQUIREMENT
Connector Mate and Unmate Forces	Per circuit when mated to a 0.635mm Sq. pin. Mate and unmate connector (male to female) at a rate of 25 ± 6 mm per minute.	1.95 N MAXIMUM insertion force & 0.56 N MINIMUM withdrawal force
Terminal Retention Force (in Housing)	Axial pullout force on the terminal in the housing at a rate of 25 ± 6 mm per minute. (Forces will change with platings and materials.)	17.8 N MINIMUM withdrawal force
Terminal Insertion Force (into Housing)	Apply an axial insertion force on the terminal at a rate of 25 ± 6 mm. (Forces will change with platings and materials.)	6.67 N MAXIMUM insertion force
Durability	Mate connectors up to 25 cycles at a maximum rate of 10 cycles per minute prior to Environmental Tests.	10 milliohms MAXIMUM (change from initial)
Vibration (Random)	Mate connectors and vibrate per EIA 364-28, test condition VII.	10 milliohms MAXIMUM (change from initial) & Discontinuity < 1 microsecond
Shock (Mechanical)	Mate connectors and shock at 50 g's with $\frac{1}{2}$ sine wave (11 milliseconds) shocks in the $\pm X, \pm Y, \pm Z$ axes (18 shocks total).	10 milliohms MAXIMUM (change from initial) & Discontinuity < 1 microsecond
Wire Pullout Force (Axial)	Apply an axial pullout force on the wire at a rate of 25 ± 6 mm. (For maximum performance use Molex application tooling with stranded tinned copper wire)	22 awg = 44 N 24 awg = 35 N 26 awg = 26 N 28 awg = 17 N 30 awg = 13 N
Normal Force	Apply a perpendicular force.	2.94 N (300 grams) average

REVISION: A	ECR/ECN INFORMATION: EC No: E2003 -0971 DATE: 2003 / 03 / 18	TITLE: PRODUCT SPECIFICATION 2.50mm & 2.54mm CENTER KK CONNECTORS	SHEET No. 3 of 5
DOCUMENT NUMBER: PS-99020-0088	CREATED / REVISED BY: B MAGUIRE	CHECKED BY: L Kiernan	APPROVED BY: M Wilhite



PRODUCT SPECIFICATION

5.3 ENVIRONMENTAL REQUIREMENTS

DESCRIPTION	TEST CONDITION	REQUIREMENT										
Shock (Thermal)	Mate connectors; expose to 5 cycles of: <table border="1"> <thead> <tr> <th>Temperature °C</th> <th>Duration (Minutes)</th> </tr> </thead> <tbody> <tr> <td>-40 +0/-3</td> <td>30</td> </tr> <tr> <td>+25 ±10</td> <td>5 MAXIMUM</td> </tr> <tr> <td>+105 +3/-0</td> <td>30</td> </tr> <tr> <td>+25 ±10</td> <td>5 MAXIMUM</td> </tr> </tbody> </table>	Temperature °C	Duration (Minutes)	-40 +0/-3	30	+25 ±10	5 MAXIMUM	+105 +3/-0	30	+25 ±10	5 MAXIMUM	10 milliohms MAXIMUM (change from initial) & Visual: No Damage
Temperature °C	Duration (Minutes)											
-40 +0/-3	30											
+25 ±10	5 MAXIMUM											
+105 +3/-0	30											
+25 ±10	5 MAXIMUM											
Thermal Aging	Mate connectors; expose to: 96 hours at 105 ± 2°C	10 milliohms MAXIMUM (change from initial]) & Visual: No Damage										
Humidity (Steady State)	Mate connectors: expose to a temperature of 40 ± 2°C with a relative humidity of 90-95% for 96 hours. Note: Remove surface moisture and air dry for 1 hour prior to measurements.	10 milliohms MAXIMUM (change from initial) & Dielectric Withstanding Voltage: No Breakdown at 500 VAC & Insulation Resistance: 1000 Megaohms MINIMUM & Visual: No Damage										
Humidity (Cyclic)	Mate connectors: cycle per EIA-364-31: 24 cycles at temperature 25 ± 3°C at 80 ± 5% relative humidity and 65 ± 3°C at 50 ± 5% relative humidity; dwell time of 1.0 hour; ramp time of 0.5 hours. {Note: Remove surface moisture and air dry for 1 hour prior to measurements.}	10 milliohms MAXIMUM (change from initial) & Dielectric Withstanding Voltage: No Breakdown at 500 VAC & Insulation Resistance: 1000 Megaohms MINIMUM & Visual: No Damage										
Solderability	Per SMES-152	Solder coverage: 95% MINIMUM (per SMES-152)										

REVISION: A	ECR/ECN INFORMATION: EC No: E2003 -0971 DATE: 2003 / 03 / 18	TITLE: PRODUCT SPECIFICATION 2.50mm & 2.54mm CENTER KK CONNECTORS	SHEET No. 4 of 5
DOCUMENT NUMBER: PS-99020-0088	CREATED / REVISED BY: B MAGUIRE	CHECKED BY: L Kiernan	APPROVED BY: M Wilhite



PRODUCT SPECIFICATION

5.3 ENVIRONMENTAL REQUIREMENTS

DESCRIPTION	TEST CONDITION	REQUIREMENT
Solder Resistance	Dip connector terminal tails in solder: Solder Duration: 5 ± 0.5 seconds; Solder Temperature: $230 \pm 5^\circ\text{C}$	Visual: No Damage to insulator material
Salt Spray	Mate connectors: Duration: 48 hours exposure; Atmosphere: salt spray from a 5% solution; Temperature: $35 +1/-2^\circ\text{C}$	10 milliohms MAXIMUM (change from initial) & Visual: No Damage
Cold Resistance	Mate connectors: Duration: 96 hours; Temperature: $-40 \pm 3^\circ\text{C}$	10 milliohms MAXIMUM (change from initial) & Visual: No Damage

6.0 PACKAGING

Parts shall be packaged to protect against damage during handling, transit and storage.

7.0 GAGES AND FIXTURES

8.0 OTHER

REVISION: A	ECR/ECN INFORMATION: EC No: E2003 -0971 DATE: 2003 / 03 / 18	TITLE: PRODUCT SPECIFICATION 2.50mm & 2.54mm CENTER KK CONNECTORS	SHEET No. 5 of 5
DOCUMENT NUMBER: PS-99020-0088	CREATED / REVISED BY: B MAGUIRE	CHECKED BY: L Kiernan	APPROVED BY: M Wilhite

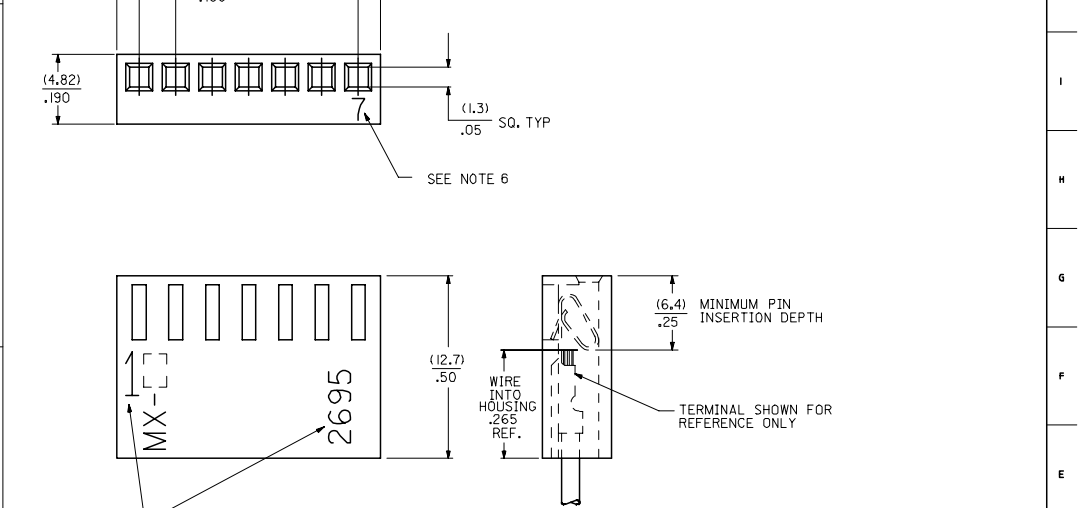
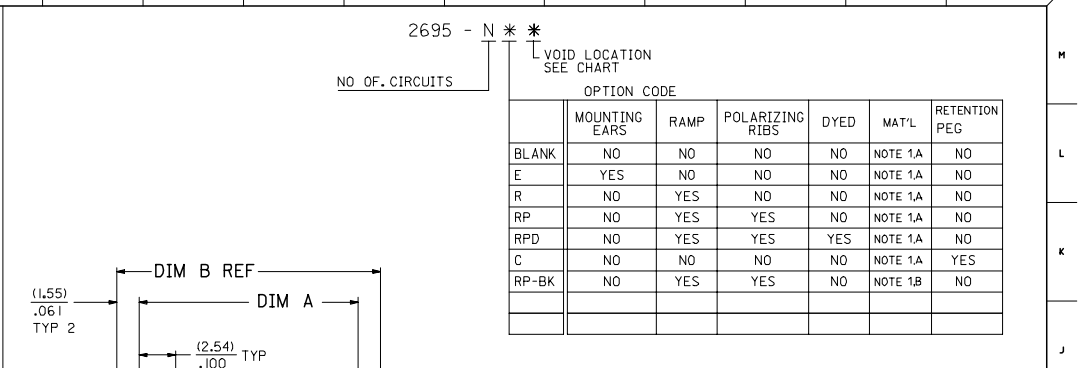
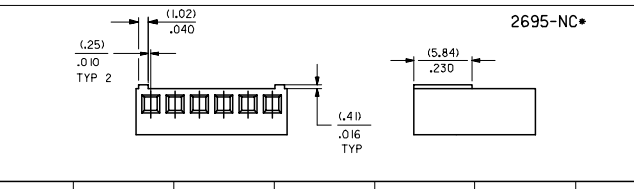
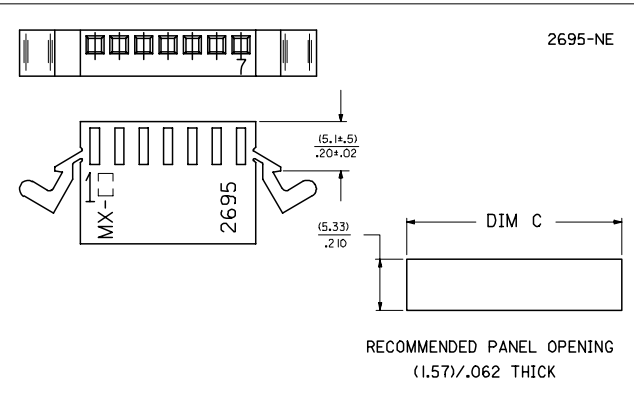
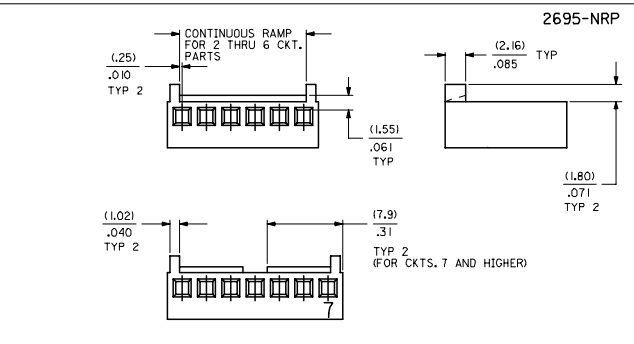
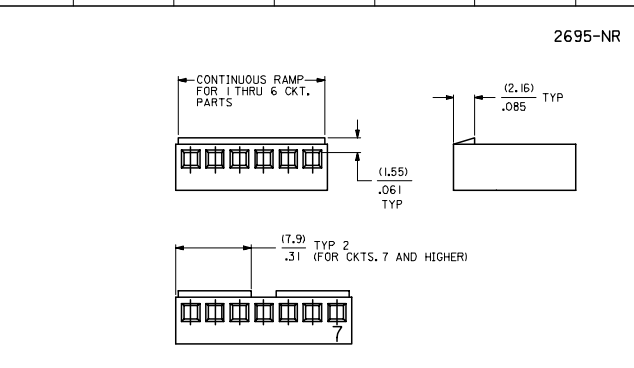

NO. OF CKT'S.	DIM. A	DIM. B	DIM. C
1	N/A	(3.10)	(7.16)
2	(2.54±.05)	(5.64)	(9.70)
3	(5.08±.05)	(8.18)	(12.24)
4	(7.62±.05)	(10.72)	(14.78)
5	(10.16±.05)	(13.26)	(17.32)
6	(12.70±.08)	(15.80)	(19.86)
7	(15.24±.08)	(18.34)	(22.40)
8	(17.78±.08)	(20.88)	(24.94)
9	(20.32±.10)	(23.42)	(27.48)
10	(22.86±.10)	(25.96)	(30.02)
11	(25.40±.10)	(28.50)	(32.56)
12	(27.94±.13)	(31.04)	(35.10)
13	(30.48±.13)	(33.58)	(37.64)
14	(33.02±.13)	(36.12)	(40.18)
15	(35.56±.13)	(38.66)	(42.72)
16	(38.10±.15)	(41.20)	(45.26)
17	(40.64±.15)	(43.74)	(47.80)
18	(43.18±.15)	(46.28)	(50.34)
19	(45.72±.15)	(48.82)	(52.88)
20	(48.26±.15)	(51.36)	(55.42)
21	(50.80±.18)	(53.90)	(57.96)
22	(53.34±.18)	(56.44)	(60.50)
23	(55.88±.18)	(58.98)	(63.04)
24	(58.42±.18)	(61.52)	(65.58)
25	(60.96±.20)	(64.06)	(68.12)
26	(63.50±.20)	(66.60)	(70.66)
27	(66.04±.20)	(69.14)	(73.20)
28	(68.58±.20)	(71.68)	(75.74)
29	(71.12±.23)	(74.22)	(78.28)
30	(73.66±.23)	(76.76)	(80.82)
31	(76.20±.23)	(79.30)	(83.36)
32	(78.74±.23)	(81.84)	(85.90)
33	(81.28±.25)	(84.38)	(88.44)
34	(83.82±.25)	(86.92)	(90.98)
35	(86.36±.25)	(89.46)	(93.52)
36	(88.90±.25)	(92.00)	(96.06)
37	(91.44±.28)	(94.54)	(98.60)
38	(93.98±.28)	(97.08)	(101.14)
39	(96.52±.28)	(99.62)	(103.68)
40	(99.06±.28)	(102.16)	(106.22)



- NOTES:
1. MATERIAL: A - NYLON, UL94V-0, COLOR: WHITE
B - NYLON, UL94V-0, COLOR: BLACK
 2. FINISH: SEE TERMINAL DRAWING
 3. THIS HOUSING CONFORMS TO MOLEX PRODUCT SPECIFICATION PS-10-07.
 4. PACKAGING: N/A
 5. HOUSING TO BE USED WITH CRIMP TYPE TERMINAL NUMBER 2759, 22-30 GAUGE WIRE WITH (.157) / .062 DIAMETER MAXIMUM WIRE INSULATION.
 6. LAST CIRCUIT NUMBER TO BE DESIGNATED ON 7 CKTS. AND HIGHER, EXCEPT WHEN 'MX' APPEARS.
 7. CIRCUIT NUMBER 'Y' AND ENGINEERING NUMBER TO APPEAR ON PARTS 3 CKTS. AND HIGHER.

ADD P/N 22-01-2032 EC NO: UCP2006-1024 DRAWN BY: 2005/11/01 CHECKED BY: 2005/11/02 APPROVED BY: 2005/11/02	QUALITY SYMBOLS 0 0	GENERAL TOLERANCES (UNLESS SPECIFIED) 4 PLACES ± .005 3 PLACES ± .005 2 PLACES ± 0.13 1 PLACE ± 0.25 ANGULAR ± 1/2°	DIMENSION STYLE MM/INCH	SCALE ---	DESIGN UNITS INCH	THIRD ANGLE PROJECTION
DRAWN BY: PEREZ-ARGUET CHECKED BY: PATEL APPROVED BY: LENZ	DATE: 1988/02/25 DATE: 1988/02/25 DATE: 1988/02/25	TITLE (2.54)/100 HOUSING FOR KK CRIMP TYPE TERMINALS 2695 SERIES DRAWING	MATERIAL NO. SEE CHART	DOCUMENT NO. SD-2695	SHEET NO. 1 OF 3	MOLEX INCORPORATED
DRAFT WHERE APPLICABLE MUST REMAIN WITHIN DIMENSIONS						
THIS DRAWING CONTAINS INFORMATION THAT IS PROPRIETARY TO MOLEX INCORPORATED AND SHOULD NOT BE USED WITHOUT WRITTEN PERMISSION						

2695-N			2695-NE			2695-NR			2695-NRP			2695-NRPD			2695-NRP-BK		
PART NO.	ENG NO.	VOID	PART NO.	ENG NO.	VOID	PART NO.	ENG NO.	VOID	PART NO.	ENG NO.	VOID	PART NO.	ENG NO.	VOID	PART NO.	ENG NO.	VOID
22-01-2011	2695-1			2695-1E			2695-1R		N/A	2695-1RP		N/A	2695-1RPD				
22-01-2021	2695-2		22-01-2022	2695-2E		22-01-2027	2695-2R		22-01-3027	2695-2RP			2695-2RPD		50-29-1557	2695-2RP-BK	
22-01-2031	2695-3		22-01-2032	2695-3E		22-01-2037	2695-3R		22-01-3037	2695-3RP			2695-3RPD		50-29-1558	2695-3RP-BK	
22-01-2041	2695-4			2695-4E		22-01-2047	2695-4R		22-01-3047	2695-4RP			2695-4RPD		50-29-1559	2695-4RP-BK	
22-01-2051	2695-5			2695-5E		22-01-2057	2695-5R		22-01-3057	2695-5RP		22-32-2051	2695-5RPD		50-29-1560	2695-5RP-BK	
22-01-2061	2695-6			2695-6E		22-01-2067	2695-6R		22-01-3067	2695-6RP			2695-6RPD		50-29-1561	2695-6RP-BK	
22-01-2071	2695-7		22-01-2072	2695-7E		22-01-2077	2695-7R		22-01-3077	2695-7RP			2695-7RPD		50-29-1562	2695-7RP-BK	
22-01-2081	2695-8			2695-8E		22-01-2087	2695-8R		22-01-3087	2695-8RP			2695-8RPD		50-29-1563	2695-8RP-BK	
22-01-2091	2695-9			2695-9E		22-01-2097	2695-9R		22-01-3097	2695-9RP			2695-9RPD		50-29-1564	2695-9RP-BK	
22-01-2101	2695-10			2695-10E		22-01-2107	2695-10R		22-01-3107	2695-10RP		22-32-2101	2695-10RPD		50-29-1565	2695-10RP-BK	
22-01-2111	2695-11			2695-11E		22-01-2117	2695-11R		22-01-3117	2695-11RP			2695-11RPD		50-29-1566	2695-11RP-BK	
22-01-2121	2695-12			2695-12E		22-01-2127	2695-12R		22-01-3127	2695-12RP			2695-12RPD		50-29-1567	2695-12RP-BK	
22-01-2131	2695-13			2695-13E		22-01-2137	2695-13R		22-01-3137	2695-13RP			2695-13RPD		50-29-1568	2695-13RP-BK	
22-01-2141	2695-14			2695-14E		22-01-2147	2695-14R		22-01-3147	2695-14RP			2695-14RPD		50-29-1569	2695-14RP-BK	
22-01-2151	2695-15			2695-15E		22-01-2157	2695-15R		22-01-3157	2695-15RP			2695-15RPD		50-29-1570	2695-15RP-BK	
22-01-2161	2695-16			2695-16E		22-01-2167	2695-16R		22-01-3167	2695-16RP			2695-16RPD		50-29-1571	2695-16RP-BK	
22-01-2171	2695-17			2695-17E		22-01-2177	2695-17R		22-01-3177	2695-17RP			2695-17RPD		50-29-1572	2695-17RP-BK	
22-01-2181	2695-18			2695-18E		22-01-2187	2695-18R		22-01-3187	2695-18RP			2695-18RPD		50-29-1573	2695-18RP-BK	
22-01-2191	2695-19			2695-19E		22-01-2197	2695-19R		22-01-3197	2695-19RP			2695-19RPD		50-29-1574	2695-19RP-BK	
22-01-2201	2695-20			2695-20E		22-01-2207	2695-20R		22-01-3207	2695-20RP			2695-20RPD		50-29-1575	2695-20RP-BK	
22-01-2211	2695-21			2695-21E		22-01-2217	2695-21R		22-01-3217	2695-21RP			2695-21RPD		50-29-1576	2695-21RP-BK	
22-01-2221	2695-22			2695-22E		22-01-2227	2695-22R		22-01-3227	2695-22RP			2695-22RPD		50-29-1577	2695-22RP-BK	
22-01-2231	2695-23			2695-23E		22-01-2237	2695-23R		22-01-3237	2695-23RP			2695-23RPD		50-29-1578	2695-23RP-BK	
22-01-2241	2695-24			2695-24E		22-01-2247	2695-24R		22-01-3247	2695-24RP			2695-24RPD		50-29-1579	2695-24RP-BK	
22-01-2251	2695-25			2695-25E		22-01-2257	2695-25R		22-01-3257	2695-25RP			2695-25RPD		50-29-1580	2695-25RP-BK	
22-01-2261	2695-26			2695-26E		22-01-2267	2695-26R		22-01-3267	2695-26RP			2695-26RPD		50-29-1581	2695-26RP-BK	
22-01-2271	2695-27			2695-27E		22-01-2277	2695-27R		22-01-3277	2695-27RP			2695-27RPD		50-29-1582	2695-27RP-BK	
22-01-2281	2695-28			2695-28E		22-01-2287	2695-28R		22-01-3287	2695-28RP			2695-28RPD		50-29-1583	2695-28RP-BK	
22-01-2291	2695-29			2695-29E		22-01-2297	2695-29R			2695-29RP			2695-29RPD				
	2695-30			2695-30E			2695-30R			2695-30RP			2695-30RPD				
	2695-31			2695-31E			2695-31R			2695-31RP			2695-31RPD				
	2695-32			2695-32E			2695-32R			2695-32RP			2695-32RPD				
22-01-2331	2695-33			2695-33E		22-01-2337	2695-33R			2695-33RP			2695-33RPD				
	2695-34			2695-34E			2695-34R			2695-34RP			2695-34RPD				
	2695-35			2695-35E			2695-35R			2695-35RP			2695-35RPD				
	2695-36			2695-36E			2695-36R			2695-36RP			2695-36RPD				
	2695-37			2695-37E			2695-37R			2695-37RP			2695-37RPD				
	2695-38			2695-38E			2695-38R			2695-38RP			2695-38RPD				
	2695-39			2695-39E			2695-39R			2695-39RP			2695-39RPD				
	2695-40			2695-40E			2695-40R			2695-40RP			2695-40RPD				
						22-01-2062	2695-06R-5	5	22-01-5102	2695-IORP-2	2						
									22-01-5044	2695-4RP-3	3						
									22-01-5103	2695-IORP-5	5						
									22-01-5111	2695-IIRP-5	5						
									22-01-5104	2695-IORP-9	9						

ADD P/N 22-01-2032 EC NO: UCP 2006-1024 DRAWN BY: JORWANDARR CHECKED BY: CHEKLSCHMIDT APPROVED BY: APRIL SMITH	QUALITY SYMBOLS  	GENERAL TOLERANCES (UNLESS SPECIFIED)		DIMENSION STYLE MM/IN		SCALE ---	DESIGN UNITS INCH	 THIRD ANGLE PROJECTION
		4 PLACES ± --- ± --- 3 PLACES ± --- ± --- 2 PLACES ± --- ± --- 1 PLACE ± --- ± ---	mm INCH ± --- ± --- ± --- ± --- ± --- ± ---	DRAWN BY PEREZ-ARGUET	DATE 1988/02/25	TITLE (2.54)/100 HOUSING FOR KK CRIMP TYPE TERMINALS 2695 SERIES DRAWING		
		ANGULAR ±1/2°		CHECKED BY PATEL	DATE 1988/02/25	MOLEX INCORPORATED		
		DRAFT WHERE APPLICABLE MUST REMAIN WITHIN DIMENSIONS		APPROVED BY LENZ	DATE 1988/02/25		DOCUMENT NO. SD-2695	

2695-NC*																	
PART NO.	ENG. NO.	VOIDS	PART NO.	ENG. NO.	VOIDS	PART NO.	ENG. NO.	VOIDS	PART NO.	ENG. NO.	VOIDS	PART NO.	ENG. NO.	VOIDS	PART NO.	ENG. NO.	VOIDS
N/A	2695-1C																
	2695-2C																
	2695-3C																
	2695-4C																
	2695-5C																
	2695-6C																
	2695-7C																
	2695-8C																
	2695-9C																
	2695-10C																
	2695-11C																
	2695-12C																
	2695-13C																
	2695-14C																
	2695-15C																
	2695-16C																
	2695-17C																
	2695-18C																
	2695-19C																
	2695-20C																
	2695-21C																
	2695-22C																
	2695-23C																
	2695-24C																
	2695-25C																
	2695-26C																
	2695-27C																
	2695-28C																
	2695-29C																
	2695-30C																
	2695-31C																
	2695-32C																
	2695-33C																
	2695-34C																
	2695-35C																
	2695-36C																
	2695-37C																
	2695-38C																
	2695-39C																
	2695-40C																

UPDATE TITLE BLOCK DEC NO: UCP2006-1024 DRAWN BY: 2005/11/01 CHECKED BY: 2005/11/02 APPROVED BY: 2005/11/02 AMS	QUALITY SYMBOLS ▽=0 ▽=0	GENERAL TOLERANCES (UNLESS SPECIFIED)		DIMENSION STYLE MM/IN		SCALE ---	DESIGN UNITS INCH	THIRD ANGLE PROJECTION	
		4 PLACES ± --- ± --- 3 PLACES ± --- ± --- 2 PLACES ± --- ± --- 1 PLACE ± --- ± ---	mm INCH	DRAWN BY SAMIEC	DATE 1989/10/30	TITLE (2.54)/100 HOUSING FOR KK CRIMP TYPE TERMINALS 2695 SERIES DRAWING			
		ANGULAR ±1/2°		CHECKED BY PATEL	DATE 1989/10/30	MOLEX INCORPORATED			
		DRAFT WHERE APPLICABLE MUST REMAIN WITHIN DIMENSIONS		APPROVED BY LENZ	DATE 1989/10/30	MATERIAL NO. SEE CHART	DOCUMENT NO. SD-2695	SHEET NO. 3 OF 3	