

NO. OF CKT'S.	DIM. A	DIM. B	DIM. C
1	N/A	(3.10)	(7.16)
2	(2.54±.05)	(5.64)	(9.70)
3	(5.08±.05)	(8.18)	(12.24)
4	(7.62±.05)	(10.72)	(14.78)
5	(10.16±.05)	(13.26)	(17.32)
6	(12.70±.08)	(15.80)	(19.86)
7	(15.24±.08)	(18.34)	(22.40)
8	(17.78±.08)	(20.88)	(24.94)
9	(20.32±.10)	(23.42)	(27.48)
10	(22.86±.10)	(25.96)	(30.02)
11	(25.40±.10)	(28.50)	(32.56)
12	(27.94±.13)	(31.04)	(35.10)
13	(30.48±.13)	(33.58)	(37.64)
14	(33.02±.13)	(36.12)	(40.18)
15	(35.56±.13)	(38.66)	(42.72)
16	(38.10±.15)	(41.20)	(45.26)
17	(40.64±.15)	(43.74)	(47.80)
18	(43.18±.15)	(46.28)	(50.34)
19	(45.72±.15)	(48.82)	(52.88)
20	(48.26±.15)	(51.36)	(55.42)
21	(50.80±.18)	(53.90)	(57.96)
22	(53.34±.18)	(56.44)	(60.50)
23	(55.88±.18)	(58.98)	(63.04)
24	(58.42±.18)	(61.52)	(65.58)
25	(60.96±.20)	(64.06)	(68.12)
26	(63.50±.20)	(66.60)	(70.66)
27	(66.04±.20)	(69.14)	(73.20)
28	(68.58±.20)	(71.68)	(75.74)
29	(71.12±.23)	(74.22)	(78.28)
30	(73.66±.23)	(76.76)	(80.82)
31	(76.20±.23)	(79.30)	(83.36)
32	(78.74±.23)	(81.84)	(85.90)
33	(81.28±.25)	(84.38)	(88.44)
34	(83.82±.25)	(86.92)	(90.98)
35	(86.36±.25)	(89.46)	(93.52)
36	(88.90±.25)	(92.00)	(96.06)
37	(91.44±.28)	(94.54)	(98.60)
38	(93.98±.28)	(97.08)	(101.14)
39	(96.52±.28)	(99.62)	(103.68)
40	(99.06±.28)	(102.16)	(106.22)

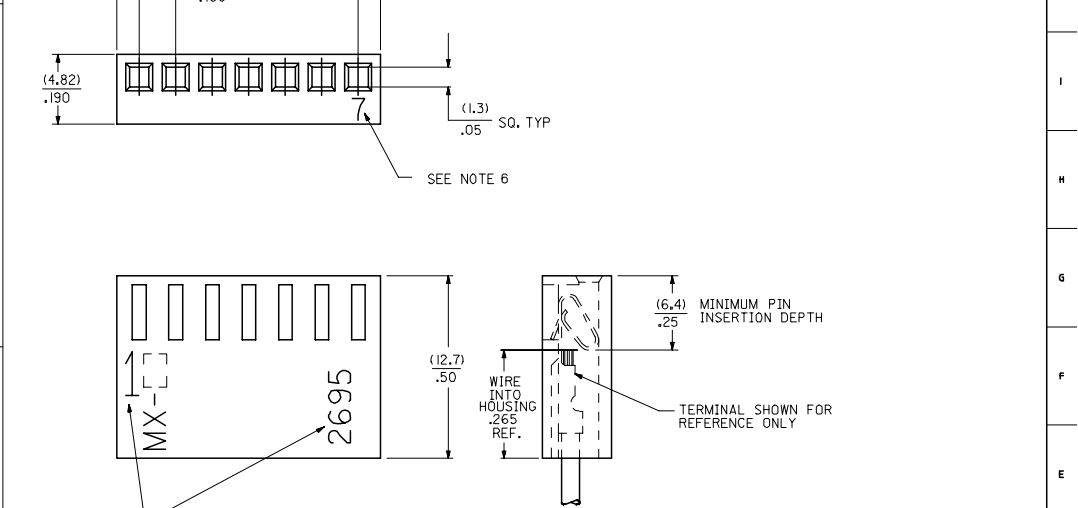

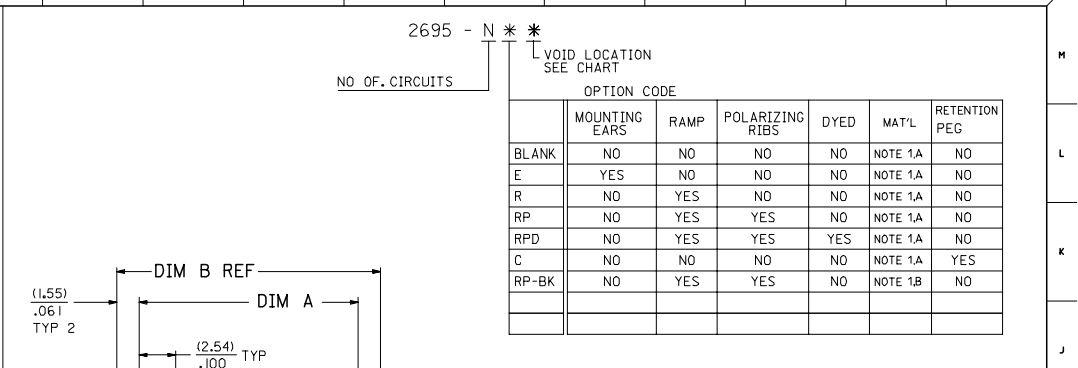
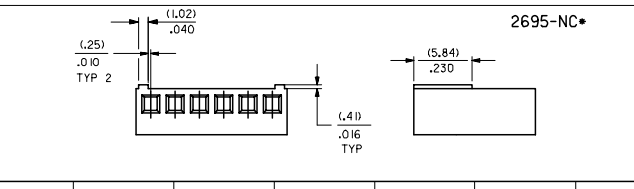
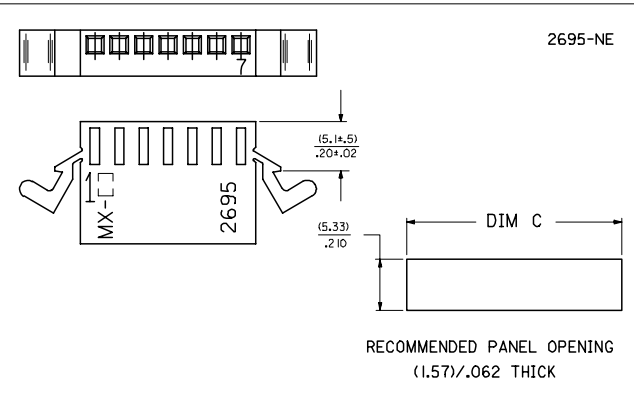
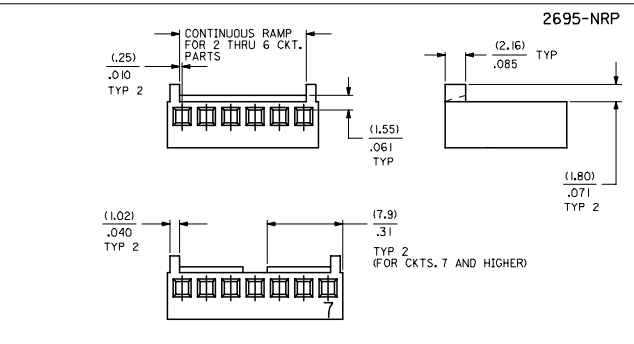
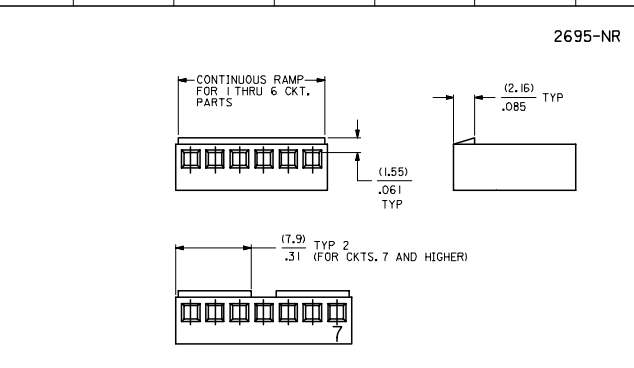

- NOTES:
1. MATERIAL: A - NYLON, UL94V-0, COLOR: WHITE
B - NYLON, UL94V-0, COLOR: BLACK
 2. FINISH: SEE TERMINAL DRAWING
 3. THIS HOUSING CONFORMS TO MOLEX PRODUCT SPECIFICATION PS-10-07.
 4. PACKAGING: N/A
 5. HOUSING TO BE USED WITH CRIMP TYPE TERMINAL NUMBER 2759, 22-30 GAUGE WIRE WITH (1.57) / .062 DIAMETER MAXIMUM WIRE INSULATION.
 6. LAST CIRCUIT NUMBER TO BE DESIGNATED ON 7 CKTS. AND HIGHER, EXCEPT WHEN "MX" APPEARS.
 7. CIRCUIT NUMBER "Y" AND ENGINEERING NUMBER TO APPEAR ON PARTS 3 CKTS. AND HIGHER.

ADD P/N 22-01-2032	QUALITY SYMBOLS	GENERAL TOLERANCES (UNLESS SPECIFIED)	DIMENSION STYLE	SCALE	DESIGN UNITS	THIRD ANGLE PROJECTION	
EC NO: UCP2006-1024	▽=0	4 PLACES ± --- ± ---	MM/IN	---	INCH		
DRW:ANDR 2005/11/01	▽=0	3 PLACES ± --- ± ---	DRAWN BY	DATE			
CHK:LSHRD 2005/11/02		2 PLACES ± 0.13 ± .01	PEREZ-ARGUET	1988/02/25			
APPR:ESH TH 2005/11/02		1 PLACE ± 0.25 ± ---	PATEL	1988/02/25			
		ANGULAR ±1/2°	APPROVED BY	DATE			
			LENZ	1988/02/25			
			MATERIAL NO.	DOCUMENT NO.			
			SEE CHART	SD-2695			
			DRAFT WHERE APPLICABLE MUST REMAIN WITHIN DIMENSIONS				
			THIS DRAWING CONTAINS INFORMATION THAT IS PROPRIETARY TO MOLEX INCORPORATED AND SHOULD NOT BE USED WITHOUT WRITTEN PERMISSION				

2695-N			2695-NE			2695-NR			2695-NRP			2695-NRPD			2695-NRP-BK		
PART NO.	ENG NO.	VOID	PART NO.	ENG NO.	VOID	PART NO.	ENG NO.	VOID	PART NO.	ENG NO.	VOID	PART NO.	ENG NO.	VOID	PART NO.	ENG NO.	VOID
22-01-2011	2695-1			2695-1E			2695-1R		N/A	2695-1RP		N/A	2695-1RPD				
22-01-2021	2695-2		22-01-2022	2695-2E		22-01-2027	2695-2R		22-01-3027	2695-2RP			2695-2RPD		50-29-1557	2695-2RP-BK	
22-01-2031	2695-3		22-01-2032	2695-3E		22-01-2037	2695-3R		22-01-3037	2695-3RP			2695-3RPD		50-29-1558	2695-3RP-BK	
22-01-2041	2695-4			2695-4E		22-01-2047	2695-4R		22-01-3047	2695-4RP			2695-4RPD		50-29-1559	2695-4RP-BK	
22-01-2051	2695-5			2695-5E		22-01-2057	2695-5R		22-01-3057	2695-5RP		22-32-2051	2695-5RPD		50-29-1560	2695-5RP-BK	
22-01-2061	2695-6			2695-6E		22-01-2067	2695-6R		22-01-3067	2695-6RP			2695-6RPD		50-29-1561	2695-6RP-BK	
22-01-2071	2695-7		22-01-2072	2695-7E		22-01-2077	2695-7R		22-01-3077	2695-7RP			2695-7RPD		50-29-1562	2695-7RP-BK	
22-01-2081	2695-8			2695-8E		22-01-2087	2695-8R		22-01-3087	2695-8RP			2695-8RPD		50-29-1563	2695-8RP-BK	
22-01-2091	2695-9			2695-9E		22-01-2097	2695-9R		22-01-3097	2695-9RP			2695-9RPD		50-29-1564	2695-9RP-BK	
22-01-2101	2695-10			2695-10E		22-01-2107	2695-10R		22-01-3107	2695-10RP		22-32-2101	2695-10RPD		50-29-1565	2695-10RP-BK	
22-01-2111	2695-11			2695-11E		22-01-2117	2695-11R		22-01-3117	2695-11RP			2695-11RPD		50-29-1566	2695-11RP-BK	
22-01-2121	2695-12			2695-12E		22-01-2127	2695-12R		22-01-3127	2695-12RP			2695-12RPD		50-29-1567	2695-12RP-BK	
22-01-2131	2695-13			2695-13E		22-01-2137	2695-13R		22-01-3137	2695-13RP			2695-13RPD		50-29-1568	2695-13RP-BK	
22-01-2141	2695-14			2695-14E		22-01-2147	2695-14R		22-01-3147	2695-14RP			2695-14RPD		50-29-1569	2695-14RP-BK	
22-01-2151	2695-15			2695-15E		22-01-2157	2695-15R		22-01-3157	2695-15RP			2695-15RPD		50-29-1570	2695-15RP-BK	
22-01-2161	2695-16			2695-16E		22-01-2167	2695-16R		22-01-3167	2695-16RP			2695-16RPD		50-29-1571	2695-16RP-BK	
22-01-2171	2695-17			2695-17E		22-01-2177	2695-17R		22-01-3177	2695-17RP			2695-17RPD		50-29-1572	2695-17RP-BK	
22-01-2181	2695-18			2695-18E		22-01-2187	2695-18R		22-01-3187	2695-18RP			2695-18RPD		50-29-1573	2695-18RP-BK	
22-01-2191	2695-19			2695-19E		22-01-2197	2695-19R		22-01-3197	2695-19RP			2695-19RPD		50-29-1574	2695-19RP-BK	
22-01-2201	2695-20			2695-20E		22-01-2207	2695-20R		22-01-3207	2695-20RP			2695-20RPD		50-29-1575	2695-20RP-BK	
22-01-2211	2695-21			2695-21E		22-01-2217	2695-21R		22-01-3217	2695-21RP			2695-21RPD		50-29-1576	2695-21RP-BK	
22-01-2221	2695-22			2695-22E		22-01-2227	2695-22R		22-01-3227	2695-22RP			2695-22RPD		50-29-1577	2695-22RP-BK	
22-01-2231	2695-23			2695-23E		22-01-2237	2695-23R		22-01-3237	2695-23RP			2695-23RPD		50-29-1578	2695-23RP-BK	
22-01-2241	2695-24			2695-24E		22-01-2247	2695-24R		22-01-3247	2695-24RP			2695-24RPD		50-29-1579	2695-24RP-BK	
22-01-2251	2695-25			2695-25E		22-01-2257	2695-25R		22-01-3257	2695-25RP			2695-25RPD		50-29-1580	2695-25RP-BK	
22-01-2261	2695-26			2695-26E		22-01-2267	2695-26R		22-01-3267	2695-26RP			2695-26RPD		50-29-1581	2695-26RP-BK	
22-01-2271	2695-27			2695-27E		22-01-2277	2695-27R		22-01-3277	2695-27RP			2695-27RPD		50-29-1582	2695-27RP-BK	
22-01-2281	2695-28			2695-28E		22-01-2287	2695-28R		22-01-3287	2695-28RP			2695-28RPD		50-29-1583	2695-28RP-BK	
22-01-2291	2695-29			2695-29E		22-01-2297	2695-29R			2695-29RP			2695-29RPD				
	2695-30			2695-30E			2695-30R			2695-30RP			2695-30RPD				
	2695-31			2695-31E			2695-31R			2695-31RP			2695-31RPD				
	2695-32			2695-32E			2695-32R			2695-32RP			2695-32RPD				
22-01-2331	2695-33			2695-33E		22-01-2337	2695-33R			2695-33RP			2695-33RPD				
	2695-34			2695-34E			2695-34R			2695-34RP			2695-34RPD				
	2695-35			2695-35E			2695-35R			2695-35RP			2695-35RPD				
	2695-36			2695-36E			2695-36R			2695-36RP			2695-36RPD				
	2695-37			2695-37E			2695-37R			2695-37RP			2695-37RPD				
	2695-38			2695-38E			2695-38R			2695-38RP			2695-38RPD				
	2695-39			2695-39E			2695-39R			2695-39RP			2695-39RPD				
	2695-40			2695-40E			2695-40R			2695-40RP			2695-40RPD				
						22-01-2062	2695-06R-5	5	22-01-5102	2695-IORP-2	2						
									22-01-5044	2695-4RP-3	3						
									22-01-5103	2695-IORP-5	5						
									22-01-5111	2695-IIRP-5	5						
									22-01-5104	2695-IORP-9	9						

ADD P/N 22-01-2032 EC NO: UCP 2006-1024 DRAWN BY: JORWANDARR CHECKED BY: CHEKLSCHMIDT APPROVED BY: APRIL SMITH AMJ	QUALITY SYMBOLS ▽=0 ▽=0	GENERAL TOLERANCES (UNLESS SPECIFIED) <table border="1"> <tr><th></th><th>mm</th><th>INCH</th></tr> <tr><td>4 PLACES</td><td>± .005</td><td>± .0002</td></tr> <tr><td>3 PLACES</td><td>± .005</td><td>± .0002</td></tr> <tr><td>2 PLACES</td><td>± .005</td><td>± .0002</td></tr> <tr><td>1 PLACE</td><td>± .005</td><td>± .0002</td></tr> </table>		mm	INCH	4 PLACES	± .005	± .0002	3 PLACES	± .005	± .0002	2 PLACES	± .005	± .0002	1 PLACE	± .005	± .0002	DIMENSION STYLE MM/IN	SCALE ---	DESIGN UNITS INCH	THIRD ANGLE PROJECTION
		mm	INCH																		
	4 PLACES	± .005	± .0002																		
	3 PLACES	± .005	± .0002																		
2 PLACES	± .005	± .0002																			
1 PLACE	± .005	± .0002																			
DRAWN BY: PEREZ-ARGUET DATE: 1988/02/25 CHECKED BY: PATEL DATE: 1988/02/25 APPROVED BY: LENZ DATE: 1988/02/25	TITLE (2.54)/100 HOUSING FOR KK CRIMP TYPE TERMINALS 2695 SERIES DRAWING	MATERIAL NO. SEE CHART	DOCUMENT NO. SD-2695	SHEET NO. 2 OF 3																	
DRAFT WHERE APPLICABLE MUST REMAIN WITHIN DIMENSIONS																					
THIS DRAWING CONTAINS INFORMATION THAT IS PROPRIETARY TO MOLEX INCORPORATED AND SHOULD NOT BE USED WITHOUT WRITTEN PERMISSION																					

2695-NC*																	
PART NO.	ENG. NO.	VOIDS	PART NO.	ENG. NO.	VOIDS	PART NO.	ENG. NO.	VOIDS	PART NO.	ENG. NO.	VOIDS	PART NO.	ENG. NO.	VOIDS	PART NO.	ENG. NO.	VOIDS
N/A	2695-1C																
	2695-2C																
	2695-3C																
	2695-4C																
	2695-5C																
	2695-6C																
	2695-7C																
	2695-8C																
	2695-9C																
	2695-10C																
	2695-11C																
	2695-12C																
	2695-13C																
	2695-14C																
	2695-15C																
	2695-16C																
	2695-17C																
	2695-18C																
	2695-19C																
	2695-20C																
	2695-21C																
	2695-22C																
	2695-23C																
	2695-24C																
	2695-25C																
	2695-26C																
	2695-27C																
	2695-28C																
	2695-29C																
	2695-30C																
	2695-31C																
	2695-32C																
	2695-33C																
	2695-34C																
	2695-35C																
	2695-36C																
	2695-37C																
	2695-38C																
	2695-39C																
	2695-40C																

UPDATE TITLE BLOCK DEC NO: UCP2006-1024 DRAWN BY: 2005/11/01 CHECKED BY: 2005/11/02 APPROVED BY: 2005/11/02 AMS	QUALITY SYMBOLS  = 0  = 0	GENERAL TOLERANCES (UNLESS SPECIFIED)		DIMENSION STYLE MM/IN		SCALE ---	DESIGN UNITS INCH	 THIRD ANGLE PROJECTION	
		4 PLACES ± --- ± --- 3 PLACES ± --- ± --- 2 PLACES ± --- ± --- 1 PLACE ± --- ± ---	mm INCH	DRAWN BY SAMIEC	DATE 1989/10/30	TITLE (2.54)/100 HOUSING FOR KK CRIMP TYPE TERMINALS 2695 SERIES DRAWING			
		ANGULAR ±1/2°		CHECKED BY PATEL	DATE 1989/10/30	MATERIAL NO. SEE CHART			
		DRAFT WHERE APPLICABLE MUST REMAIN WITHIN DIMENSIONS		APPROVED BY LENZ	DATE 1989/10/30	DOCUMENT NO. SD-2695		SHEET NO. 3 OF 3	